



Description & Features:

- Extremely robust and stable long-term
- Shock and vibration resistant
- $\pm 0.5\%$ FSO accuracy
- 15,000 psi nominal pressure range
- Permissible overpressure up to 22,500 psi
- Standard 80% shunt calibration
- Eight gauge sensor design
- 5 year warranty

Applications:

- Designed to be used with WECO® 1502 style union fittings for high pressure/harsh oil well environments like fracturing, cementing, acidizing and mud pressure management

Specifications	
Electrical Output Signal	2-wire: 4-20 mA / $V_s=10-30$ Vdc
Electrical Connection	MIL-/ Bendix 6-pin
Housing	316L SS
Pressure Port/Diaphragm	316L SS
Normal Operating Temperature Range	-40°F to 257°F (-40°C to 125°C)
Compensated Temperature Range	23°F to 140°F (-5°C to 60°C)
Temperature Effect on Zero/Span	Less than $\pm 2\%$ FSO / 100K
Accuracy	$\pm 0.5\%$ FSO
Stability	Shock: 500 g / 1 msec
Enclosure Rating	IP67

Order Codes

Range	Permissible Over-pressure	Code
15,000 psi	22,500 psi	LOH425

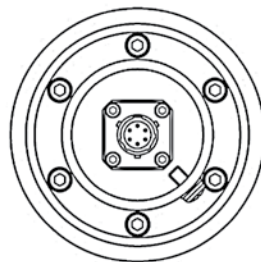
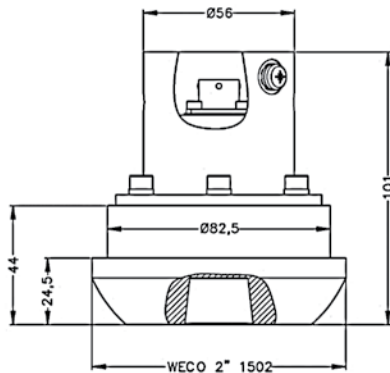

Wiring Diagram

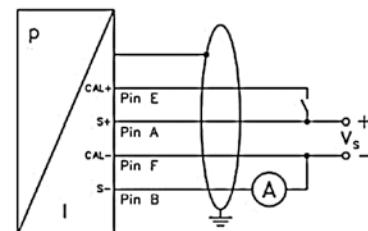

Note: Measurements are in mm.

WECO® is a registered trademark of FMC Technologies