

In-Stock Same Day Switches



Whitman In-Stock "Distributor" Switches come with fewer available options relative to our [fully customizable products](#), but ship same day when your order is placed prior to 1pm EST making them ideal for those on a tight timeline. These switches come with a **Range Label and Pointer** affording the end user Full Field Adjustability, along with a number of other available options on amperage, set point ranges, and electrical fittings.



P88 In-Stock Switch

Part # P88

The P88 In-Stock switches come with fewer options than our [customizable P88 switches](#), but are available for same day shipping when an order is placed prior to 1pm EST. These economical pressure switches are typically used in applications where reliable switch control supersedes accuracy of set point. Controlling on and off functions for fans and pumps where one may need a wide differential to prevent over-cycling is an ideal application use for the P88.

- Set Point Range: 1.5 to 500 PSIG
- Max System Pressure: 600 PSIG
- Temperature range: -31°F to + 185°F (-35°C to +85°C)
- Amps: 1 - 25 Amps Max
- Fitting: 1/4" NPT Male

P119 In-Stock Switch

Part # P119

The P119 In-Stock switches come with fewer options than our customizable P119 switches, but are available for same day shipping when an order is placed prior to 1pm EST. These Zinc Diecast Body Pressure Switches are the inexpensive version of the P117G and recommended for indoor OEM use. The compact nature of these switches make them ideal for tight spaces.



- Set Point Range: 0.80 to 500 PSIG
- Max System Pressure: 150% of sensor capacity
- Temperature range: -65°F to +225°F (-54°C to +107°C)
- Amps: 1 -5 Amps
- Fitting: 1/8" NPT Male

Order from: **C A Briggs Company**

622 Mary Street; Suite 101; Warminster, PA 18974

Phone: 267-673-8117 - Fax: 267-673-8118

Sales@cabriggs.com - www.cabriggs.com



J205 In-Stock Switch

Part # J205

The J205 In-Stock switches come with fewer options than our customizable J205 switches, but are available for same day shipping when an order is placed prior to 1pm EST. These High-Pressure Low Set Point Pressure Switches are among our most versatile offering, affording the end user an extensive operating environment and a wide range of set point optionality.

- Set Point Range: 0.80 to 800 PSIG
- Max System Pressure: 5,000 PSIG
- Temperature range: -65°F to +225°F (-54°C to +107°C)
- Amps: 1-5 Amps Max
- Fitting: 1/8" NPT Male or 1/4" VCR Male



W117 In-Stock Switch

Part # W117

The W117 In-Stock switches come with fewer options than our customizable W117 switches, but are available for same day shipping when an order is placed prior to 1pm EST. These Ultra-Pure Stainless Steel Pressure Switches have all welded stainless steel interiors which are Helium leak checked to pass 4 x 10⁻⁹ Std CC/Sec. The W117 is used in silicon wafer ovens, numerous medical devices and other applications where even the slightest impurities are not tolerated.

- Set Point Range: 0.80 to 500 PSIG
- Max System Pressure: 150% of Sensor Capacity
- Temperature range: -65°F to +225°F (-54°C to +107°C)
- Amps: 1 - 5 Amps
- Fitting: 1/8" NPT Male or 1/4" VCR Male



P117 In-Stock Switch

Part # P117

In-Stock switches come with fewer options than our customizable P117 switches, but are available for same day shipping when an order is placed prior to 1pm EST. These Stainless-Steel Miniature Pressure switches are sharp, highly versatile devices that can be used in hundreds of OEM and routine mechanical applications. It is among our most popular switches given its durability and diverse set point options.

- Set Point Range: 0.80 to 500 PSIG
- Max System Pressure: 150% of Sensor Capacity
- Temperature range: -65°F to +225°F (-54°C to +107°C)
- Fitting: 1/8" NPT Male

Order from: **C A Briggs Company**

622 Mary Street; Suite 101; Warminster, PA 18974

Phone: 267-673-8117 - Fax: 267-673-8118

Sales@cabriggs.com - www.cabriggs.com

PRESSURE SWITCHES

We manufacture a wide range of pressure switches to meet the needs of any industrial application and operating environment. Our preset switches are set at the factory to the specifications and parameters to fit our customers' requirements. Our field adjustable switches allow our customers the flexibility of easily setting the switch parameters in the field as driven by the needs of the project.

	Pressure Switch Selection Guide	5
	Part Number Construction	6
P88G	Economical Pressure Switch	7
P90	Severe Environment Pressure Switch	8
P95	High Pressure Severe Environment Pressure Switch	9
P100G	High Accuracy Low Pressure Environment Pressure Switch	10
P117G	Stainless Steel Miniature Pressure Switch	11
P117LG	NEMA 4 Stainless Steel Pressure Switch	12
W117G	Ultra Pure Stainless Steel Pressure Switch	13
W117LG	NEMA 4 Ultra Pure Stainless Steel Pressure Switch	14
P119G	Zinc Diecast Body Pressure Switch	15
J205G	High Pressure Low Set Point Pressure Switch	16
J205LG	NEMA 4 High Pressure Low Set Point Pressure Switch	17
P605	High Pressure High Set Point High Accuracy Pressure Switch	18
P605L	NEMA 4 High Pressure/Set Point/Accuracy Pressure Switch	19
J705	High Pressure High Set Point Pressure Switch	20
J705L	NEMA 4 Economical High Pressure/Set Point Pressure Switch	21



Order from: **C A Briggs Company**
622 Mary Street; Suite 101; Warminster, PA 18974
Phone: 267-673-8117 - Fax: 267-673-8118
Sales@cabriggs.com - www.cabriggs.com

Pressure Switch Selection Guide

The chart below gives an overview of our pressure switch product catalog at Whitman, and the functionality of each of our switches. Depending on your desired set point, and maximum system pressure, you will find a switch that will meet your specific needs and exceed your expectations.

SPECIFICATIONS

	P88G	P90	P95	P100G	P117G / P117LG	P119G	W117G / W117LG	J205G / J205LG	P605 / P605L	J705 / J705L
Minimum Set Point (PSIG)	1.5	0.75	0.75	0.10	0.80	0.80	0.80	0.80	400	500
Maximum Set Point (PSIG)	500	400	400	15.0	500	500	500	800	6,000	6,000
Maximum System Pressure (PSIG)	600	600	4,000	15	500	500	500	5,000	6,000	6,000
Proof Pressure (PSIG)	600	600	4,000	20	750	750	750	5,000	9,000	9,000

Steps Required for Identifying the Right Pressure Switch for your Application:

- Step 1:** Identify the Maximum System Pressure on your Application
- Step 2:** Identify your Set Point and if on “Increasing” or “Decreasing” pressure
- Step 3:** Select a Sensor Code that applies to the Maximum System Pressure and Set Point Range desired for your application – Reference Table A on the corresponding Switch Page
- Step 4:** Determine your Set Point Option: C-set (Customer set, field adjustable), K-set (Factory pre-set to customer specifications, field adjustable), F-set (Factory set, non-adjustable)
- Step 5:** Select your Electrical Amperage and Contact Selection – Reference Electrical Switch Tables
- Step 6:** Select your Electrical Interface – Reference Electrical Interface Options
- Step 7:** Select your Wire Length if longer than 12” (Standard) is desired
- Step 8:** Confirm Wetted Materials are compatible with Fluid and Environment
- Step 9:** Select Additional Options – Reference Additional Options or Consult Factory

Please refer to our website at www.whitmancontrols.com for additional information or contact our engineering department at engineering@whitmancontrols.com.

Limitation of Application Liability:

Whitman Controls Corporation assumes the buyer to be expert in the intended application of Whitman Controls’ products. Whitman Controls claims no special expertise in the application of its products in the buyer’s equipment. Whitman Controls accepts no responsibility for the buyer’s selection and use of Whitman Controls products. Buyer’s interpretation and implementation of application suggestions and recommendations by Whitman Controls, general or specific, transmitted verbally or in writing, published or unpublished, is strictly at the buyer’s own risk.

Terms and Conditions:

All sales FOB Bristol, CT prepaid and added to the invoice. All prices net. Prices and specifications are subject to change without notice. Terms with established credit are net 30 days. Returns will not be accepted without a return authorization number issued by Whitman Controls. A 30% restocking fee will be charged on all items returned unless merchandise shipped was due to a Whitman Controls error.

International Terms and Conditions:

All sales FOB Bristol, CT. Payment prepaid in U.S. Dollars, on a U.S. Bank or by electronic transfer to a Whitman Controls banking institution.

Three Year Limited Warranty

The proven quality and reliability of Whitman Controls Corporation Pressure, Vacuum, Liquid Level, and Temperature Switches are backed by our 3 Year Limited Warranty when used in normal operation. Our complete warranty statement is provided with all quotations or is available on request.

Order from: **C A Briggs Company**; 622 Mary Street; Suite 101 - Warminster, PA 18974
 Phone: 267-673-8117 - Fax: 267-673-8118; E-Mail: Sales@cabriggs.com - www.cabriggs.com

All Pressure, Vacuum and Compound Switch Models Except P88, P90, P95

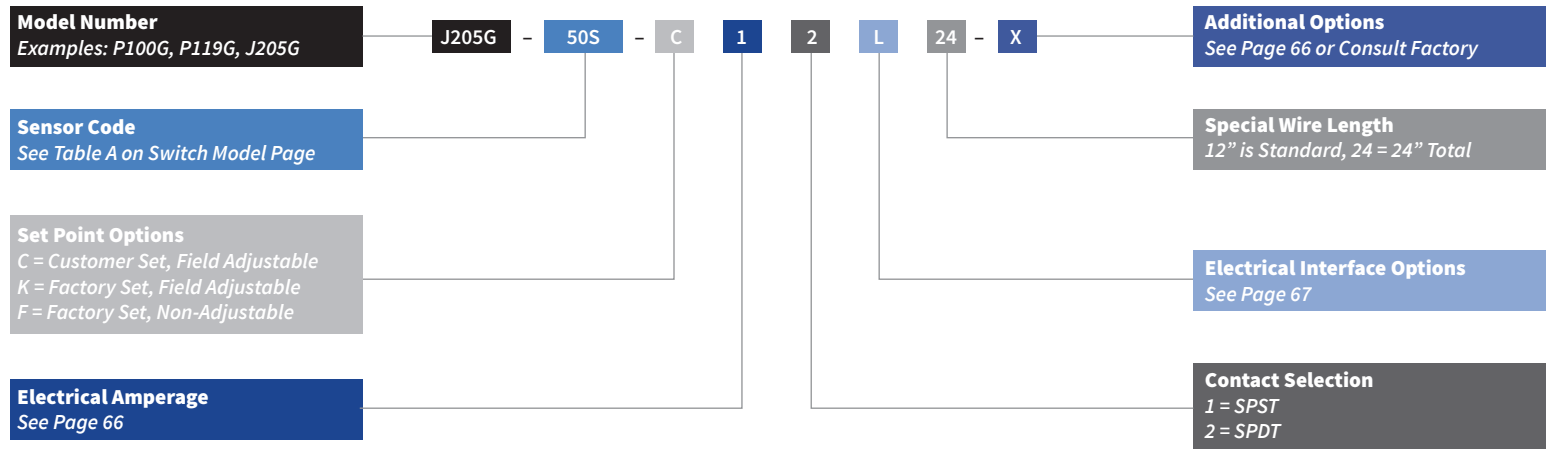

P88 Pressure, Vacuum, Compound Switches

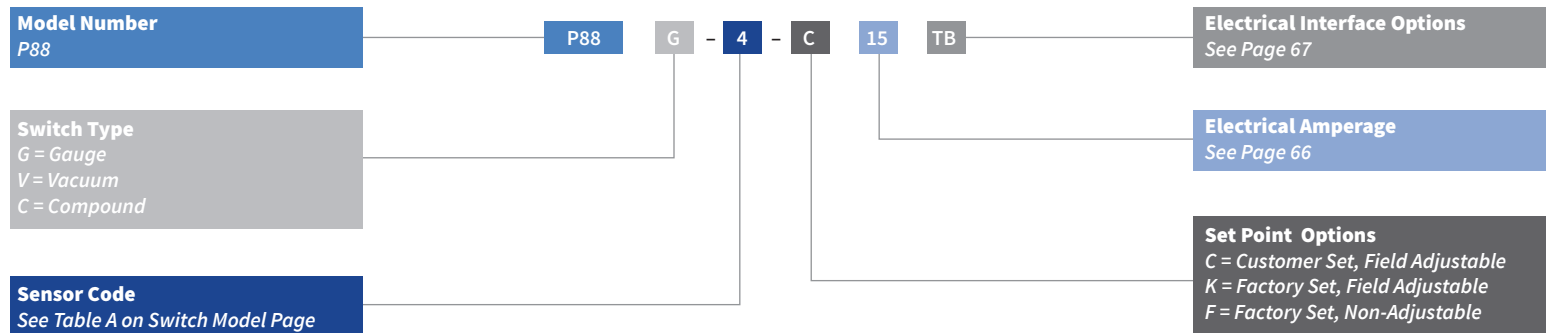

P90 / P95 Pressure Switch

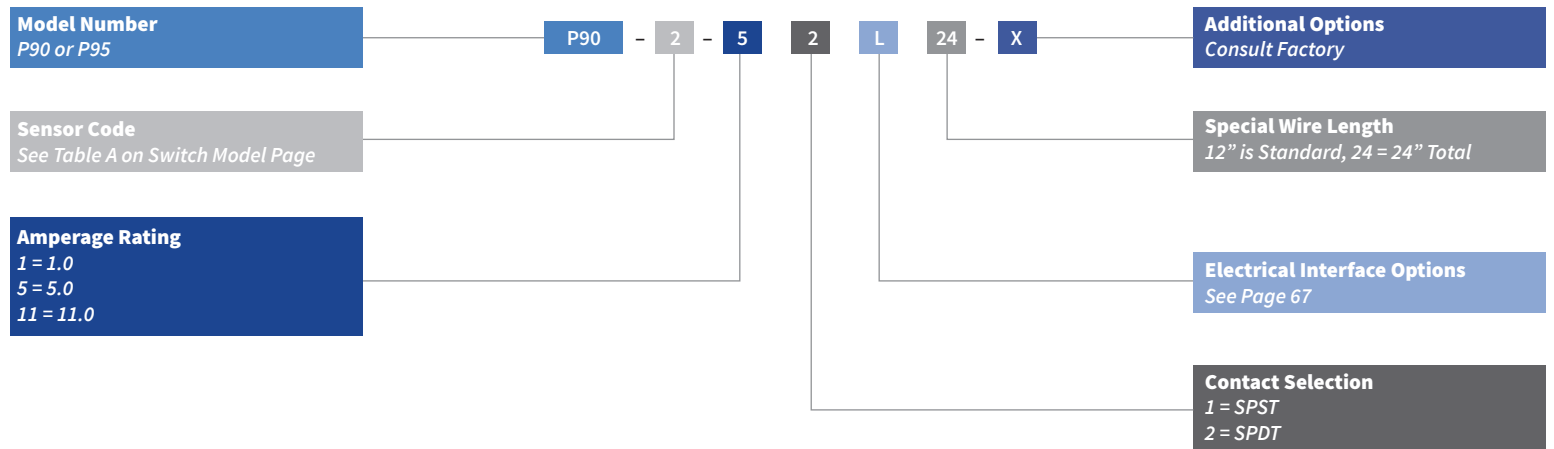

P88G

Economical Pressure Switch

OVERVIEW

The Whitman Controls P88G Economical Pressure switches are typically used in applications where reliable switch control supersedes accuracy of set point. These switches can be used in dry indoor applications or placed within an enclosure. Controlling on and off functions for fans and pumps where one may need a wide differential to prevent over-cycling is an ideal application use for the P88G.

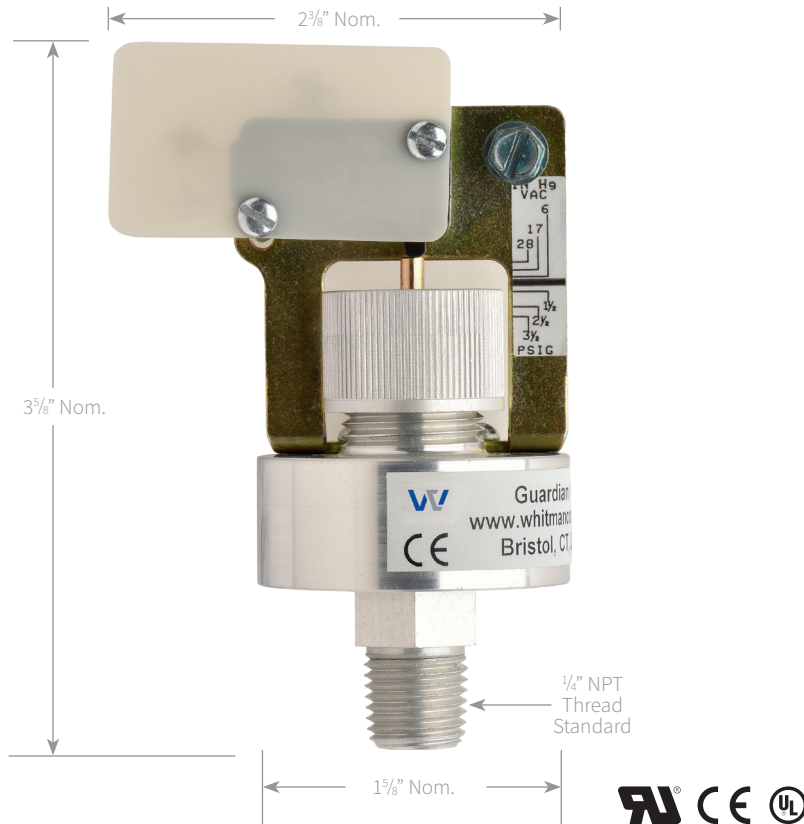

KEY FEATURES

- Consistent switch control
- Set point options: Factory set, field adjustable, or a combination
- Extensive operating temperature range

SPECIFICATIONS

- **Set point Range:** 1.5 to 500 PSIG
- **Max System Pressure:** 600 PSIG
- **Temperature Range:** -31°F to +185°F (-35°C to +85°C)
- **Amps:** 1-25 Amps Max
- **Sensor Element:** Diaphragm
- **Weight:** 7.4 oz
- **Cycling:** Not to exceed 100 CPM
- **Wetted Parts:**
 Diaphragm: Buna N and Brass
 Seal: Loctite #271
 Body with Fitting: Zinc alloy, chromate finish
 Optional Thread: 1/4-18 BSPT male, 1/8-27 NPT male

SENSOR CODE AND PERFORMANCE CHARACTERISTICS

SENSOR CODE	Table A		Table B
	MAXIMUM SYSTEM PRESSURE*	SET POINT REPEATABILITY	SET POINT RANGE
	PSIG	PSIG	PSIG
3	600	± 0.15	1.5 - 3.5
4	600	± 1.0	3.0 - 40.0
5	600	± 5.0	30.0 - 150.0
6	600	± 20.0	100.0 - 500.0

*Exceeding sensor capacity may cause shift in set point

CAUTION: Customer Media and environment must be compatible with construction materials as outlined above

Order from: **C A Briggs Company**; 622 Mary Street; Suite 101 - Warminster, PA 18974
 Phone: 267-673-8117 - Fax: 267-673-8118; E-Mail: Sales@cabriggs.com - www.cabriggs.com

P90

Severe Environment Pressure Switch

OVERVIEW

The Whitman Controls P90 Severe Environment Pressure switches are built to operate in harsh conditions and are typically used in vehicle applications both off road and on. As these switches are NEMA 6 rated, they are weather proof and briefly submersible. Ideal use is on log skidders, tractors, handi-vans, cranes and numerous other applications where shock, vibration and weather are of primary concern.

KEY FEATURES

- Shock resistant up to 150G
- Vibration durability of 10Hz to 2,000Hz @ 10G's
- Water resistant up to 1,000 PSIG high pressure spray
- Cold Storage up to -67°F (-55°F)
- NEMA 6 Rated: Weather-proof and briefly submersible
- Set point options: Factory set to customer specification, non-adjustable
- Extensive operating temperature range
- Wide range of electrical interfaces available
- SPDT or SPST availability

SPECIFICATIONS

- **Set Point Range:** 0.75 to 400 PSIG
- **Max System Pressure:** 600 PSIG
- **Temperature Range:** -40°F to +257°F (-40°C to +125°C)
- **Amps:** 1-11 Amps Max
- **Sensor Element:** Diaphragm
- **Weight:** 7.0 oz
- **Cycling:** Not to exceed 20 CPM
- **Wetted Parts:**
 Diaphragm: Viton
 Lower Body: Zinc alloy, chromate finish
 Standard Thread: 1/8" NPT
 Optional Threads: 12-20 SAE, other fittings available in quantities

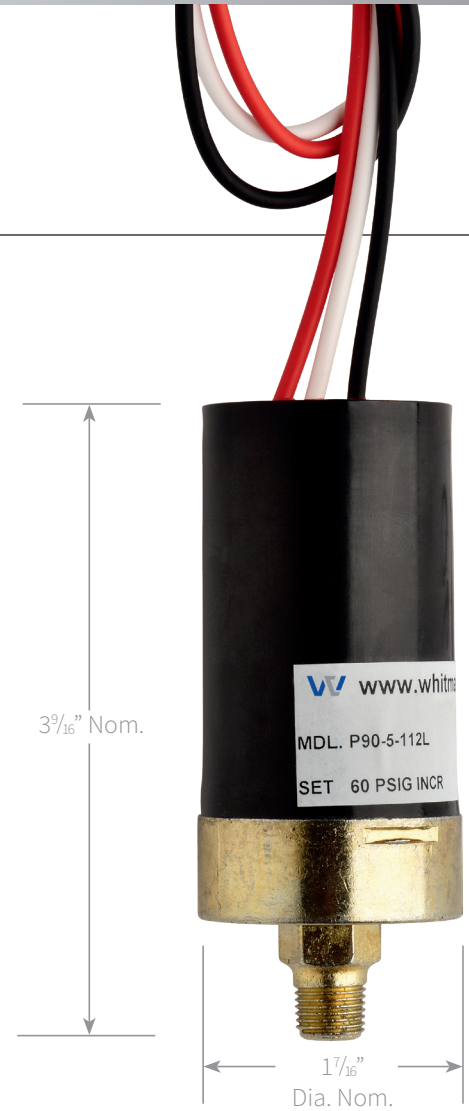

SENSOR CODE AND PERFORMANCE CHARACTERISTICS

Table A			Table B	
SENSOR CODE	MAXIMUM SYSTEM PRESSURE*	SET POINT REPEATABILITY	SET POINT RANGE	
	PSIG	PSIG	DECREASING PSIG	INCREASING PSIG
1	600	± 0.75	0.75 - 3.0	2.0 - 4.25
2	600	± 1.0	3.0 - 6.0	4.2 - 8.0
3	600	± 2.0	6.0 - 20.0	7.0 - 24.0
4	600	± 5.0	12.0 - 47.0	14.0 - 50.0
5	600	± 10.0	30.0 - 110.0	38.0 - 125.0
6	600	± 20.0	75.0 - 270.0	85.0 - 270.0
7	600	± 40.0	100.0 - 330.0	125.0 - 400.0

*Exceeding sensor capacity may cause shift in set point

CAUTION: Customer Media and environment must be compatible with construction materials as outlined above

Order from: **C A Briggs Company**; 622 Mary Street; Suite 101 - Warminster, PA 18974
 Phone: 267-673-8117 - Fax: 267-673-8118; E-Mail: Sales@cabriggs.com - www.cabriggs.com

P95

High Pressure Severe Environment Pressure Switch

OVERVIEW

The Whitman Controls P95 Severe Environment Pressure switches are built to operate in harsh conditions and are typically used in vehicle applications both off road and on. As these switches are NEMA 6 rated, they are weather proof and briefly submersible. Resiliency in high pressure conditions is the key differentiator relative to its P90 sister switch, with the ability to withstand hydraulic spikes to 4,000 psig. Ideal use is on log skidders, tractors, cranes and numerous other applications where pressure spikes, shock, vibration and weather are of primary concern.

KEY FEATURES

- Ability to withstand hydraulic spikes to 4,000 psig
- Shock resistant up to 150G
- Vibration durability of 10Hz to 2,000Hz @ 10G's
- Water resistant up to 1,000 PSIG high pressure spray
- Cold Storage up to -67°F (-55°F)
- NEMA 6 Rated: Weather-proof and briefly submersible
- Set point options: Factory set to customer specification, non-adjustable
- Extensive operating temperature range

SPECIFICATIONS

- **Set Point Range:** 0.75 to 400 PSIG
- **Max System Pressure:** 4000 PSIG
- **Temperature Range:** -40°F to +257°F (-40°C to +125°C)
- **Amps:** 1-11 Amps Max
- **Sensor Element:** Diaphragm
- **Weight:** 7.0 oz
- **Cycling:** Not to exceed 20 CPM
- **Wetted Parts:**
Diaphragm: Viton
Lower Body: 303 Stainless steel
Standard Thread: 1/8" NPT
Optional Threads: 12-20 SAE, other fittings available in quantities



SENSOR CODE AND PERFORMANCE CHARACTERISTICS

Table A			Table B	
SENSOR CODE	MAXIMUM SYSTEM PRESSURE*	SET POINT REPEATABILITY	SET POINT RANGE	
	PSIG	PSIG	DECREASING PSIG	INCREASING PSIG
1	4000	± 0.75	0.75 - 3.0	2.0 - 4.25
2	4000	± 1.0	3.0 - 6.0	4.2 - 8.0
3	4000	± 2.0	6.0 - 20.0	7.0 - 24.0
4	4000	± 5.0	12.0 - 47.0	14.0 - 50.0
5	4000	± 10.0	30.0 - 110.0	38.0 - 125.0
6	4000	± 20.0	75.0 - 270.0	85.0 - 270.0
7	4000	± 40.0	100.0 - 330.0	125.0 - 400.0

*Exceeding sensor capacity may cause shift in set point

CAUTION: Customer Media and environment must be compatible with construction materials as outlined above

Order from: **C A Briggs Company**; 622 Mary Street; Suite 101 - Warminster, PA 18974
 Phone: 267-673-8117 - Fax: 267-673-8118; E-Mail: Sales@cabriggs.com - www.cabriggs.com

P100G

High Accuracy Low Pressure Environment Pressure Switch

OVERVIEW

The Whitman Controls P100G High Accuracy Low Pressure Environment Pressure switches are ideal in light pressure applications where precision of setpoint must be high and repeatability low. These switches are commonly used in natural gas well heads, natural gas generator sets, and air applications like forced draft blowers. The P100G can be used both in dry indoor applications or within an enclosure.

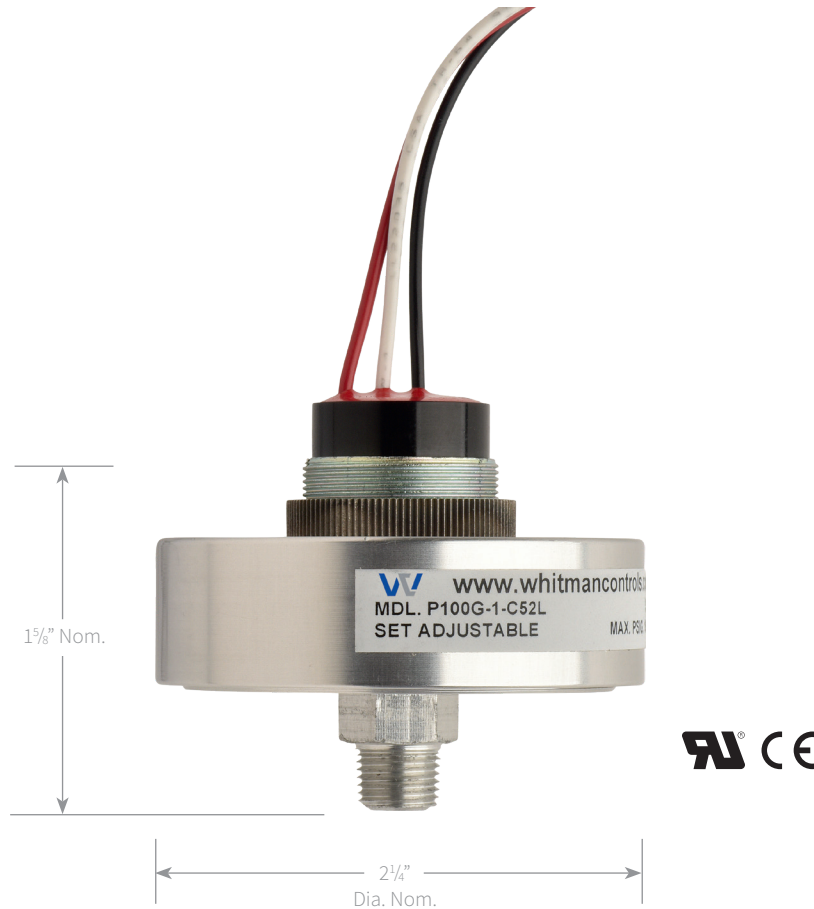

KEY FEATURES

- Highly accurate setpoints and repeatability
- Set point options: Factory set, field adjustable, or a combination
- Extensive operating temperature range
- Wide range of electrical interfaces available
- SPDT or SPST availability

SPECIFICATIONS

- **Set Point Range:** See Table A
- **Max System Pressure:** 15 PSIG
- **Temperature Range:** -65°F to +190°F (-54°C to +88°C)
- **Amps:** 5 Amps Max
- **Sensor Element:** Diaphragm
- **Weight:** 7.8 oz (varies slightly with electrical interface selection)
- **Cycling:** Not to exceed 100 CPM
- **Wetted Parts:**
 Diaphragm: Buna N with 316 stainless steel reinforcing
 Seal: Loctite #271
 Body: Anodized aluminum
 Standard Thread: 1/8-27 NPT male

SENSOR CODE AND PERFORMANCE CHARACTERISTICS

SENSOR CODE	Table A						Table B					
	MAXIMUM SYSTEM PRESSURE*			SET POINT REPEATABILITY			SET POINT RANGE					
	PSIG	Inches Hg	Inches H ₂ O	PSIG	Inches Hg	Inches H ₂ O	DECREASING			INCREASING		
						PSIG	Inches Hg	Inches H ₂ O	PSIG	Inches Hg	Inches H ₂ O	
1	15.0	-	-	± 0.03	-	-	0.10 - 14.27	-	-	0.15 - 15.0	-	-
1	-	30.54	-	-	± 0.06	-	-	0.21 - 29.06	-	0.31 - 30.54	-	-
1	-	-	415.2	-	-	± 0.8	-	-	2.75 - 395.03	-	-	4.15 - 415.2

*Exceeding sensor capacity may cause shift in set point

CAUTION: Customer Media and environment must be compatible with construction materials as outlined above

Order from: **C A Briggs Company**; 622 Mary Street; Suite 101 - Warminster, PA 18974
 Phone: 267-673-8117 - Fax: 267-673-8118; E-Mail: Sales@cabriggs.com - www.cabriggs.com

P117G

Stainless Steel Miniature Pressure Switch

OVERVIEW

The Whitman Controls P117G Stainless Steel Miniature Pressure switches are sharp, highly versatile devices that can be used in hundreds of OEM and routine mechanical applications. There are numerous fitting and electrical connection options available including TB, TS, Military, and DIN Connectors.

KEY FEATURES

- Miniature size
- Stainless steel body
- Set point options: Factory set, field adjustable, or a combination
- Extensive operating temperature range
- Wide range of electrical interfaces available
- SPDT or SPST availability

SPECIFICATIONS

- **Set Point Range:** 0.80 to 500 PSIG
- **Proof Pressure:** 150% of sensor capacity
- **Temperature Range:** -65°F to +225°F (-54°C to +107°C)
- **Amps:** 5 Amps Max
- **Sensor Element:** Capsule
- **Weight:** 3.0 oz (varies slightly with electrical interface selection)
- **Cycling:** 3H/5H – Not to exceed 60 CPM, 10H/25H/50H – Not to exceed 20 CPM
- **Wetted Parts:**
 Capsule: 17-7 PH
 Seal: Loctite #271
 Fitting: 303 Stainless steel
 Standard Thread: 1/8-27 NPT male
 Optional Threads: 1/4-18 NPT male
 7/16-20 UNF male



(Shown with TB Interface)

SENSOR CODE AND PERFORMANCE CHARACTERISTICS

Table A			Table B	
SENSOR CODE	MAXIMUM SYSTEM PRESSURE*	SET POINT REPEATABILITY	SET POINT RANGE	
	PSIG	PSIG	DECREASING PSIG	INCREASING PSIG
3H	30	± 0.6	0.8 - 3.0	1.6 - 30.0
5H	50	± 1.0	2.0 - 48.0	3.0 - 50.0
10H	100	± 2.0	3.0 - 96.5	4.5 - 100.0
25H	250	± 5.0	7.5 - 242.5	9.7 - 250.0
50H	500	± 10.0	15.0 - 485.0	20.0 - 500.0

*Exceeding sensor capacity may cause shift in set point

CAUTION: Customer Media and environment must be compatible with construction materials as outlined above

Order from: **C A Briggs Company**; 622 Mary Street; Suite 101 - Warminster, PA 18974
 Phone: 267-673-8117 - Fax: 267-673-8118; E-Mail: Sales@cabriggs.com - www.cabriggs.com

P117LG

NEMA 4 Stainless Steel Pressure Switch

OVERVIEW

The Whitman Controls P117LG NEMA 4 Stainless Steel Pressure Switches are the weather-proof, liquid-resistant version of the P117G. The NEMA 4 rating makes these rugged switches suitable for outside applications or in areas of condensing humidity. Unlike the P117G, the P117LG set point is factory set to customer specification and is non-adjustable. Numerous fitting options are available.

KEY FEATURES

- NEMA 4 Rated
- Stainless steel body
- Weather-proof, liquid resistant
- Set point options: Factory set to customer specification, non-adjustable
- Extensive operating temperature range
- Wide range of electrical interfaces available
- SPDT or SPST availability

SPECIFICATIONS

- **Set Point Range:** 0.80 to 500 PSIG
- **Proof Pressure:** 150% of sensor capacity
- **Temperature Range:** -65°F to +225°F (-54°C to +107°C)
- **Amps:** 5 Amps Max
- **Sensor Element:** Capsule
- **Weight:** 3.0 oz (varies slightly with electrical interface selection)
- **Cycling:** 3H/5H – Not to exceed 60 CPM, 10H/25H/50H – Not to exceed 20 CPM
- **Wetted Parts:**
 Capsule: 17-7 PH
 Seal: Loctite #271
 Fitting: 303 Stainless steel
 Standard Thread: 1/8-27 NPT male
 Optional Threads: 1/4-18 NPT male, 7/16-20 UNF male



SENSOR CODE AND PERFORMANCE CHARACTERISTICS

SENSOR CODE	Table A		Table B	
	MAXIMUM SYSTEM PRESSURE*	SET POINT REPEATABILITY	SET POINT RANGE	
	PSIG	PSIG	DECREASING PSIG	INCREASING PSIG
3H	30	± 0.6	0.8 - 3.0	1.6 - 30.0
5H	50	± 1.0	2.0 - 48.0	3.0 - 50.0
10H	100	± 2.0	3.0 - 96.5	4.5 - 100.0
25H	250	± 5.0	7.5 - 242.5	9.7 - 250.0
50H	500	± 10.0	15.0 - 485.0	20.0 - 500.0

*Exceeding sensor capacity may cause shift in set point

CAUTION: Customer Media and environment must be compatible with construction materials as outlined above

Order from: **C A Briggs Company**; 622 Mary Street; Suite 101 - Warminster, PA 18974
 Phone: 267-673-8117 - Fax: 267-673-8118; E-Mail: Sales@cabriggs.com - www.cabriggs.com

W117G

Ultra Pure Stainless Steel Pressure Switch

OVERVIEW

The Whitman Controls W117G Ultra Pure Stainless Steel Pressure Switches have all welded stainless steel interiors which are Helium leak checked to pass 4 x 10⁻⁹ Std CC/Sec. These switches are used in silicon wafer ovens, numerous medical devices and other applications where even the slightest impurities are not tolerated. There are a number of fitting options available featuring the 1/4" VCR Male and many interface options to fit any application.

KEY FEATURES

- High purity
- Welded stainless steel body and interiors, helium leak checked
- Set point options: Factory set, field adjustable, or a combination
- Extensive operating temperature range
- Wide range of electrical interfaces available
- SPDT or SPST availability

SPECIFICATIONS

- **Set Point Range:** 0.80 to 500 PSIG
- **Proof Pressure:** 150% of sensor capacity
- **Temperature Range:** -65°F to +225°F (-54°C to +107°C)
- **Amps:** 5 Amps Max
- **Sensor Element:** Electric beam welded, helium leak tested
- **Weight:** 3.0 oz (approx.)
- **Cycling:** 3H/5H – Not to exceed 60 CPM, 10H/25H/50H – Not to exceed 20 CPM
- **Wetted Parts:**
Capsule: 17-7 PH, electron beam welded
Fitting: 303 Stainless steel
Standard Thread: 1/8-27 NPT male
Optional Threads: 1/4 VCR male, 1/4-18 NPT male



SENSOR CODE AND PERFORMANCE CHARACTERISTICS

Table A			Table B	
SENSOR CODE	MAXIMUM SYSTEM PRESSURE*	SET POINT REPEATABILITY	SET POINT RANGE	
	PSIG	PSIG	DECREASING	INCREASING
3H	30	± 0.6	0.8 - 28.5	1.6 - 30.0
5H	50	± 1.0	2.0 - 48.0	3.0 - 50.0
10H	100	± 2.0	3.0 - 96.5	4.5 - 100.0
25H	250	± 5.0	7.5 - 242.5	9.7 - 250.0
50H	500	± 10.0	15.0 - 485.0	20.0 - 500.0

*Exceeding sensor capacity may cause shift in set point

CAUTION: Customer Media and environment must be compatible with construction materials as outlined above

Order from: **C A Briggs Company**; 622 Mary Street; Suite 101 - Warminster, PA 18974
 Phone: 267-673-8117 - Fax: 267-673-8118; E-Mail: Sales@cabriggs.com - www.cabriggs.com

W117LG

NEMA 4 Ultra Pure Stainless Steel Pressure Switch

OVERVIEW

The Whitman Controls W117LG NEMA 4 Ultra Pure Stainless Steel Pressure Switches have all welded stainless steel interiors which are Helium leak checked to pass 4 x 10⁻⁹ Std cc/sec. These are the NEMA 4 rated weather-proof, liquid-resistant version of the W117G, suitable for outside applications or in areas of condensing humidity. These switches are used in silicon wafer ovens, numerous medical devices, and other applications where even the slightest impurities are not tolerated.

KEY FEATURES

- High purity
- NEMA 4 Rated
- Stainless steel body and interior, helium leak checked
- Weather-proof and liquid-resistant
- Set point options: Factory set to customer specification, non-adjustable
- Extensive operating temperature range
- Wide range of electrical interfaces available
- SPDT or SPST availability

SPECIFICATIONS

- **Set Point Range:** 0.80 to 500 PSIG
- **Proof Pressure:** 150% of sensor capacity
- **Temperature Range:** -65°F to +225°F (-54°C to +107°C)
- **Amps:** 5 Amps Max
- **Sensor Element:** Capsule – Electric beam welded, helium leak tested
- **Weight:** 3.0 oz (varies slightly with electrical interface selection)
- **Cycling:** 3H/5H – Not to exceed 60 CPM, 10H/25H/50H – Not to exceed 20 CPM
- **Wetted Parts:**
Capsule: 17-7 PH, electron beam welded
Fitting: 303 Stainless steel
Standard Thread: 1/8-27 NPT male

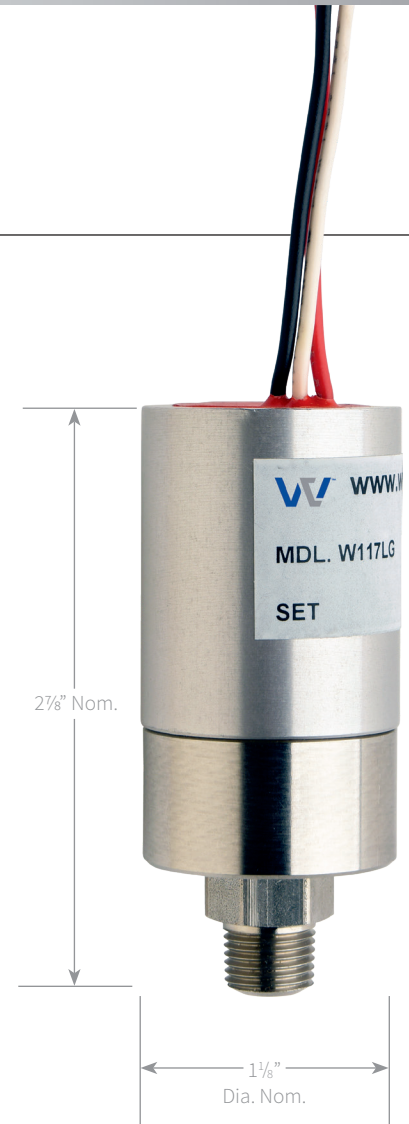

SENSOR CODE AND PERFORMANCE CHARACTERISTICS

SENSOR CODE	Table A		Table B	
	MAXIMUM SYSTEM PRESSURE*	SET POINT REPEATABILITY	SET POINT RANGE	
	PSIG	PSIG	DECREASING	INCREASING
3H	30	± 0.6	0.8 - 28.5	1.6 - 30.0
5H	50	± 1.0	2.0 - 48.0	3.0 - 50.0
10H	100	± 2.0	3.0 - 96.5	4.5 - 100.0
25H	250	± 5.0	7.5 - 242.5	9.7 - 250.0
50H	500	± 10.0	15.0 - 485.0	20.0 - 500.0

*Exceeding sensor capacity may cause shift in set point

CAUTION: Customer Media and environment must be compatible with construction materials as outlined above

Order from: **C A Briggs Company**; 622 Mary Street; Suite 101 - Warminster, PA 18974
Phone: 267-673-8117 - Fax: 267-673-8118; E-Mail: Sales@cabriggs.com - www.cabriggs.com

P119G

Zinc Diecast Body Pressure Switch

OVERVIEW

The Whitman Controls P119G Zinc Diecast Body Pressure Switches are the inexpensive version of the P117G and recommended for indoor OEM use. It is used as a pressure limit switch on X-Ray tubes and Cat Scan Tubes as well as a safety switch in numerous applications. The compact nature of these switches make them ideal for tight spaces. They are available with a cast in 1/4" NPT fitting as an option. There are also several electrical interface options available.

KEY FEATURES

- Zinc Diecast Body
- Set point options: Factory set, field adjustable, or a combination
- Extensive operating temperature range
- Wide range of electrical interfaces available
- SPDT or SPST availability

SPECIFICATIONS

- **Set Point Range:** 0.80 to 500 PSIG
- **Proof Pressure:** 150% of sensor capacity
- **Temperature Range:** -65°F to +225°F (-54°C to +107°C)
- **Amps:** 5 Amps Max
- **Sensor Element:** Capsule
- **Weight:** 2.0 oz (varies slightly with electrical interface selection)
- **Cycling:** 3H/5H – Not to exceed 60 CPM, 10H/25H/50H – Not to exceed 20 CPM
- **Wetted Parts:**
 Capsule: 17-7 PH
 Seal: Loctite #271
 Body with Fitting:
 Round body – Zamac 3, chromate finish
 Hex body – ZA8, chromate finish
 Standard Thread: 1/8"-27 NPT male



SENSOR CODE AND PERFORMANCE CHARACTERISTICS

SENSOR CODE	Table A		Table B	
	MAXIMUM SYSTEM PRESSURE*	SET POINT REPEATABILITY	SET POINT RANGE	
	PSIG	PSIG	DECREASING PSIG	INCREASING PSIG
3H	30	± 0.6	0.8 - 3.0	1.6 - 30.0
5H	50	± 1.0	2.0 - 48.0	3.0 - 50.0
10H	100	± 2.0	3.0 - 96.5	4.5 - 100.0
25H	250	± 5.0	7.5 - 242.5	9.7 - 250.0
50H	500	± 10.0	15.0 - 485.0	20.0 - 500.0

*Exceeding sensor capacity may cause shift in set point

CAUTION: Customer Media and environment must be compatible with construction materials as outlined above

Order from: **C A Briggs Company**; 622 Mary Street; Suite 101 - Warminster, PA 18974
 Phone: 267-673-8117 - Fax: 267-673-8118; E-Mail: Sales@cabriggs.com - www.cabriggs.com

J205G

High Pressure Low Set Point Pressure Switch

OVERVIEW

The Whitman Controls J205G High Pressure Low Set Point Pressure Switches are among our most versatile offering, affording the end user an extensive operating environment and a wide range of set point optionality. These switches can be exposed to high pressure without compromising integrity or switch functionality. Uses include gas bottle change switches and oil or water supply control. They are frequently used in pump and reservoir applications. The internals are stainless steel with a diaphragm O-ring that is available in numerous compounds.

KEY FEATURES

- Overpressure feature, allowing the switch to be subject to high pressure without compromising integrity
- Set point options: Factory set, field adjustable, or a combination
- Extensive operating temperature range
- Wide range of electrical interfaces available
- SPDT or SPST availability
- Wide range of set point optionality

SPECIFICATIONS

- **Set Point Range:** 0.80 to 800 PSIG
- **Max System Pressure:** 5,000 PSIG
- **Temperature Range:** -65°F to +225°F (-54°C to +107°C)
- **Amps:** 5 Amps Max
- **Sensor Element:** Diaphragm
- **Weight:** 4.0 oz (varies slightly with electrical interface selection)
- **Cycling:** Not to exceed 100 CPM
- **Wetted Parts:**
 Diaphragm: 316 Stainless steel
 Seal: Loctite #271
 Body/Fitting: 303 Stainless steel
 O-Ring: Buna N Standard (Special material available upon request)
 Standard Thread: 1/8-27 NPT male



SENSOR CODE AND PERFORMANCE CHARACTERISTICS

SENSOR CODE	Table A			Table B	
	MAXIMUM SET POINT	MAXIMUM SYSTEM PRESSURE*	SET POINT REPEATABILITY	SET POINT RANGE	
	PSIG	PSIG	PSIG	DECREASING PSIG	INCREASING PSIG
2S	20	5000	± 0.8	0.8 - 16.3	1.2 - 20.0
5S	50	5000	± 2.0	2.0 - 42.5	2.0 - 50.0
10S	100	5000	± 4.0	4.0 - 91.0	4.0 - 100.0
25S	250	5000	± 10.0	10.0 - 222.0	10.0 - 250.0
50S	500	5000	± 20.0	20.0 - 432.0	20.0 - 500.0
80S	800	5000	± 40.0	50.0 - 700.0	100.0 - 800.0

*Exceeding sensor capacity may cause shift in set point

CAUTION: Customer Media and environment must be compatible with construction materials as outlined above

Order from: **C A Briggs Company**; 622 Mary Street; Suite 101 - Warminster, PA 18974
 Phone: 267-673-8117 - Fax: 267-673-8118; E-Mail: Sales@cabriggs.com - www.cabriggs.com

J205LG

NEMA 4 High Pressure Low Set Point Pressure Switch

OVERVIEW

The Whitman Controls J205LG NEMA 4 High Pressure Low Set Point Pressure Switches are among our most versatile offering, affording the end user an extensive operating environment and a wide range of set point optionality. These switches can be exposed to high pressure without compromising integrity or switch functionality. The J205LG is the NEMA 4 rated weather-proof, liquid-resistant version of the J205G, suitable for outside applications or in areas of condensing humidity. Uses include gas bottle change switches and oil or water supply control. They are frequently used in pump and reservoir applications. The internals are stainless steel with a diaphragm O-ring that is available in numerous compounds such as Buna (standard), Viton, Neoprene and Kalrez.

KEY FEATURES

- Overpressure feature, allowing the switch to be subject to high pressure without compromising integrity
- Weather-proof and liquid-resistant
- Set point options: Factory set to customer specification, non-adjustable
- Extensive operating temperature range
- Wide range of electrical interfaces available
- SPDT or SPST availability
- Wide range of set point optionality
- NEMA 4 Rated

SPECIFICATIONS

- **Set Point Range:** 0.80 to 800 PSIG
- **Max System Pressure:** 5,000 PSIG
- **Temperature Range:** -65°F to +225°F (-54°C to +107°C)
- **Amps:** 5 Amps Max
- **Sensor Element:** Diaphragm
- **Weight:** 4.0 oz (approx.)
- **Cycling:** Not to exceed 100 CPM
- **Wetted Parts:**
 Diaphragm: 316 Stainless steel
 Seal: Loctite #271
 Body/Fitting: 303 Stainless steel
 O-Ring: Buna N Standard, special materials available upon request
 Standard Thread: 1/8"-27 NPT male



SENSOR CODE AND PERFORMANCE CHARACTERISTICS

SENSOR CODE	Table A			Table B	
	MAXIMUM SET POINT	MAXIMUM SYSTEM PRESSURE*	SET POINT REPEATABILITY	SET POINT RANGE	
	PSIG	PSIG	PSIG	DECREASING PSIG	INCREASING PSIG
2S	20	5000	± 0.8	0.8 - 16.3	1.2 - 20.0
5S	50	5000	± 2.0	2.0 - 42.5	2.0 - 50.0
10S	100	5000	± 4.0	4.0 - 91.0	4.0 - 100.0
25S	250	5000	± 10.0	10.0 - 222.0	10.0 - 250.0
50S	500	5000	± 20.0	20.0 - 432.0	20.0 - 500.0
80S	800	5000	± 40.0	50.0 - 700.0	100.0 - 800.0

*Exceeding sensor capacity may cause shift in set point

CAUTION: Customer Media and environment must be compatible with construction materials as outlined above

Order from: **C A Briggs Company**; 622 Mary Street; Suite 101 - Warminster, PA 18974
 Phone: 267-673-8117 - Fax: 267-673-8118; E-Mail: Sales@cabriggs.com - www.cabriggs.com

P605

High Pressure High Set Point High Accuracy Pressure Switch

OVERVIEW

The Whitman Controls P605 High Pressure High Set Point High Accuracy Pressure Switches are a line of severe application controls that can withstand massive pressure spikes from hydraulic systems. These switches can see pressure spikes to 9,000 psig without comprising switch integrity or functionality. They also afford the end user higher set points to complement more severe environments and low set point repeatability. The P605 switches feature adjustable Military or DIN electrical connectors plus numerous fitting options to meet any custom design.

KEY FEATURES

- Higher set points to complement more severe environments
- Set point options: Factory set, field adjustable, or a combination
- Extensive operating temperature range
- Wide range of electrical interfaces available
- SPDT or SPST availability
- Extremely durable with the ability to withstand pressure spikes to 9,000 psig

SPECIFICATIONS

- **Set Point Range:** 200 to 6,000 PSIG
- **Max System Pressure:** 9,000 PSIG
- **Temperature Range:** -65°F to +225°F (-54°C to +107°C)
- **Amps:** 5 Amps Max
- **Sensor Element:** Piston
- **Weight:** 7.0 oz (varies slightly with electrical interface selection)
- **Cycling:** Not to exceed 20 CPM
- **Wetted Parts:**
Limp Diaphragm: Kapton
Seal: Loctite #271
O-Ring: Viton standard, Teflon available
Adapter/Fitting: 303 Stainless steel
Standard Thread: ¼-18 NPT male
Optional Threads: ⅛-27 NPT male, 7/16-20 UNF male



(Shown with DN Interface)

SENSOR CODE AND PERFORMANCE CHARACTERISTICS

Table A			Table B	
SENSOR CODE	MAXIMUM SYSTEM PRESSURE*	SET POINT REPEATABILITY	SET POINT RANGE	
	PSIG	PSIG	DECREASING PSIG	INCREASING PSIG
0	3000	± 25.0	200.0 - 600.0	200.0 - 600.0
1	3000	± 50.0	400.0 - 1500.0	400.0 - 1500.0
2	6000	± 150.0	1250.0 - 2750.0	1250.0 - 2750.0
3	9000	± 300.0	2750.0 - 5000.0	3500.0 - 6000.0

*Exceeding sensor capacity may cause shift in set point

CAUTION: Customer Media and environment must be compatible with construction materials as outlined above

Order from: **C A Briggs Company**; 622 Mary Street; Suite 101 - Warminster, PA 18974
 Phone: 267-673-8117 - Fax: 267-673-8118; E-Mail: Sales@cabriggs.com - www.cabriggs.com

P605L

NEMA 4 High Pressure High Set Point High Accuracy Pressure Switch

OVERVIEW

The Whitman Controls P605L NEMA 4 High Pressure High Set Point High Accuracy Pressure Switches are a line of severe application controls that can withstand massive pressure spikes from hydraulic systems. These switches can see pressure spikes to 9,000 psig without comprising switch integrity or functionality. They also afford the end user higher set points to complement more severe environments and low set point repeatability. The P605L is the NEMA 4 rated weather-proof, liquid-resistant version of the P605, suitable for outside applications or in areas of condensing humidity. The P605L switches feature adjustable Military or DIN electrical connectors plus numerous fitting options to meet any custom design.

KEY FEATURES

- Extremely durable - can withstand pressure spikes to 9,000 psig
- Higher set points to complement more severe environments
- NEMA 4 Rated
- Weather-proof and liquid resistant
- Set point options: Factory set, field adjustable, or a combination
- Extensive operating temperatures
- Wide range of electrical interfaces available
- SPDT or SPST availability

SPECIFICATIONS

- **Set Point Range:** 200 to 6,000 PSIG
- **Max System Pressure:** 9,000 PSIG
- **Temperature Range:** -65°F to +225°F (-54°C to +107°C)
- **Amps:** 5 Amps Max
- **Sensor Element:** Piston
- **Weight:** 7.0 oz (varies slightly with electrical interface selection)
- **Cycling:** Not to exceed 20 CPM
- **Wetted Parts:**
Limp Diaphragm: Kapton
Seal: Loctite #271
O-Ring: Viton standard, Teflon available
Adapter / Fitting: 303 Stainless steel
Standard Thread: 1/4-18 NP male

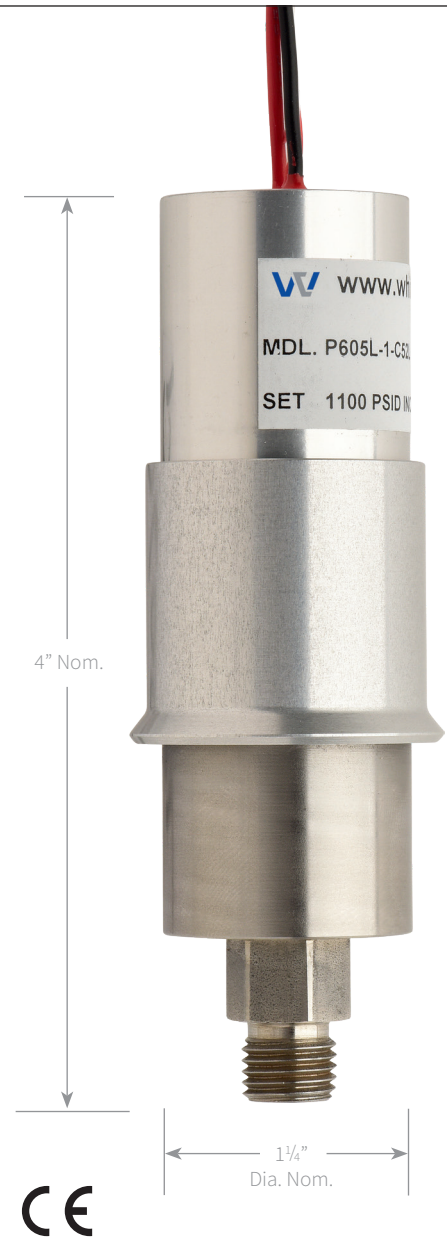

SENSOR CODE AND PERFORMANCE CHARACTERISTICS

Table A			Table B	
SENSOR CODE	MAXIMUM SYSTEM PRESSURE*	SET POINT REPEATABILITY	SET POINT RANGE	
	PSIG	PSIG	DECREASING PSIG	INCREASING PSIG
0	3000	± 25.0	200.0 - 600.0	200.0 - 600.0
1	3000	± 50.0	400.0 - 1500.0	400.0 - 1500.0
2	6000	± 150.0	1250.0 - 2750.0	1250.0 - 2750.0
3	9000	± 300.0	2750.0 - 5000.0	3500.0 - 6000.0

*Exceeding sensor capacity may cause shift in set point

CAUTION: Customer Media and environment must be compatible with construction materials as outlined above

Order from: **C A Briggs Company**; 622 Mary Street; Suite 101 - Warminster, PA 18974
 Phone: 267-673-8117 - Fax: 267-673-8118; E-Mail: Sales@cabriggs.com - www.cabriggs.com

J705

High Pressure High Set Point Pressure Switch

OVERVIEW

The Whitman Controls J705 High Pressure High Set Point Pressure Switches are among our most durable products, affording the end user higher set points to complement more severe environments without sacrificing set point repeatability. These switches are designed for use with various oils, waters, and assorted gases, and are resilient against impeller spikes from pumps. These switches can see pressure spikes to 9,000 psig without comprising switch integrity or functionality. They are available with several internal O-ring options, assorted fittings and electrical connectors to meet any custom application.



KEY FEATURES

- Extremely resilient with the ability to withstand pressure spikes to 9,000 psig
- High durability with higher set points to complement more severe environments
- Set point options: Factory set, field adjustable, or a combination
- Extensive operating temperature range
- Wide range of electrical interfaces available
- SPDT or SPST availability

SPECIFICATIONS

- **Set Point Range:** 500 to 6,000 PSIG
- **Max System Pressure:** 6,000 PSIG
- **Temperature Range:** -65°F to +225°F (-54°C to +107°C)
- **Amps:** 5 Amps Max
- **Sensor Element:** Piston
- **Weight:** 4.0 oz (varies slightly with electrical interface selection)
- **Cycling:** Not to exceed 20 CPM
- **Wetted Parts:**
Piston: 17-4 PH
O-Ring: Buna N standard, special materials available upon request
Fitting: 303 Stainless steel
Standard Thread: 1/8-27 NPT male

SENSOR CODE AND PERFORMANCE CHARACTERISTICS

Table A			Table B	
SENSOR CODE	MAXIMUM SYSTEM PRESSURE*	SET POINT REPEATABILITY	SET POINT RANGE	
		PSIG	DECREASING PSIG	INCREASING PSIG
3	3000	± 25.0	500	500
		± 50.0	1000	1000
		± 75.0	1500	1500
		± 100.0	2000	2000
		± 125.0	2500	2500
		± 150.0	2800	3000
4	5000	± 45.0	600	600
		± 60.0	1000	1000
		± 85.0	1500	1500
		± 100.0	2000	2000
		± 125.0	2500	2500
		± 150.0	3000	3000
		± 175.0	3500	3500
		± 200.0	4000	4000
5	6000	± 250.0	4500	5000
		± 65.0	700	700
		± 75.0	1000	1000
		± 85.0	1500	1500
		± 100.0	2000	2000
		± 150.0	3000	3000
		± 200.0	4000	4000
		± 250.0	5000	5000
		± 300.0	5500	6000

*Exceeding sensor capacity may cause shift in set point
CAUTION: Customer Media and environment must be compatible with construction materials as outlined above

Order from: **C A Briggs Company**; 622 Mary Street; Suite 101 - Warminster, PA 18974
Phone: 267-673-8117 - Fax: 267-673-8118; E-Mail: Sales@cabriggs.com - www.cabriggs.com

J705L

NEMA 4 Economical High Pressure High Set Point Pressure Switch

OVERVIEW

The Whitman Controls J705L NEMA 4 Economical High Pressure High Set Point Pressure Switches are among our most durable switches, with the ability to withstand significant pressure spikes while affording the end user high set point optionality. These are the weather-proof, liquid-resistant version of the J705 suitable for outside applications or in areas of condensing humidity. These switches are designed for use with various Oils, Water and assorted gases. They are good with Impeller Spikes from pumps. They are available with several internal O-ring options, assorted fittings and electrical connectors.

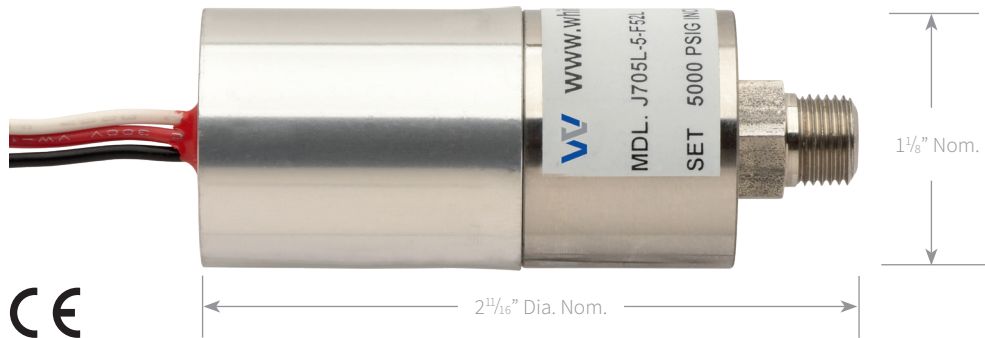

KEY FEATURES

- Extremely resilient with the ability to withstand pressure spikes to 9,000 psig
- High durability with high set point options
- NEMA 4 Rated
- Weather-proof and liquid-resistant
- Set point options: Factory set to customer specification, non-adjustable
- Extensive operating temperature range
- Wide range of electrical interfaces available
- SPDT or SPST availability

SPECIFICATIONS

- **Set Point Range:** 200 to 6,000 PSIG
- **Max System Pressure:** 6,000 PSIG
- **Temperature Range:** -65°F to +225°F (-54°C to +107°C)
- **Amps:** 5 Amps Max
- **Sensor Element:** Piston
- **Weight:** 4.0 oz (varies slightly with electrical interface selection)
- **Cycling:** Not to exceed 20 CPM
- **Wetted Parts:** Piston: 17-4 PH
O-Ring: Buna N standard, special materials available upon request
Fitting: 303 Stainless steel
Standard Thread: 1/8-27 NPT male

SENSOR CODE AND PERFORMANCE CHARACTERISTICS

SENSOR CODE	Table A		Table B	
	MAXIMUM SYSTEM PRESSURE*	SET POINT REPEATABILITY	SET POINT RANGE	
	PSIG	PSIG	DECREASING PSIG	INCREASING PSIG
3	3000	± 25.0	500	500
		± 50.0	1000	1000
		± 75.0	1500	1500
		± 100.0	2000	2000
		± 125.0	2500	2500
		± 150.0	2800	3000
4	5000	± 45.0	600	600
		± 60.0	1000	1000
		± 85.0	1500	1500
		± 100.0	2000	2000
		± 125.0	2500	2500
		± 150.0	3000	3000
		± 175.0	3500	3500
		± 200.0	4000	4000
5	6000	± 65.0	700	700
		± 75.0	1000	1000
		± 85.0	1500	1500
		± 100.0	2000	2000
		± 150.0	3000	3000
		± 200.0	4000	4000
		± 250.0	5000	5000
		± 300.0	5500	6000

*Exceeding sensor capacity may cause shift in set point
CAUTION: Customer Media and environment must be compatible with construction materials as outlined above

Electrical Switch Selection Tables

ALL MODELS EXCEPT P88, P90 & P95

SWITCH CODE	VOLTS AC / DC	AMP RESISTIVE	AMP INDUCTIVE	CONTACT MATERIAL
.1	125 / 30	.1	-	GOLD PLATE
1	115 / 28	1 / 1	1 / .5	GOLD
3	125 / 30	3 / 2	-	SILVER
5	250 / 28	5 / 5	5 / 3	SILVER

Above switches are SPDT, but may be used as SPST.

MODELS P90 & P95 ONLY

SWITCH CODE	VOLTS	AMP RESISTIVE	HORSE POWER @ 250 VAC	CONTACT MATERIAL
1	30 VDC / 125 VAC	1	-	GOLD
5	30 VDC / 250 VAC	5	-	SILVER
11	30 VDC / 250 VAC	11	1/4	SILVER

Above switches are SPDT, but may be used as SPST.

MODEL P88 ONLY

SWITCH CODE	VOLTS	AMP RESISTIVE	HORSE POWER @ 250 VAC	CONTACT MATERIAL
1	30 VDC / 125 VAC	1	-	GOLD
5	250 VAC	5	0.1	SILVER
10	250 VAC	10	1/3	SILVER
15	250 VAC	15	1/2	SILVER
25	250 VAC	25	2	SILVER

Above switches are SPDT but may be used as SPST. 25 Amp switch available on codes 4, 5, & 6 only.

For dry circuitry, i.e. 5VDC-50 mA or less, use gold contact switch (Code .1 or 1). If less than 20mA, performance of electrical switch will be environmentally dependent. If there is some form of contamination (dust, dirt, oil, chemical residue, etc.) at point of contact, the electrical switch could perform intermittently, as there would be insufficient current to burn off any possible contamination.

Optional Electrical Interfaces

Available for Models

P100, P117, P119, J205, P605, J705 and W117



T
Standard solder type terminals also accept AMP 60789-2 and 60598-4 Pin Receptacles

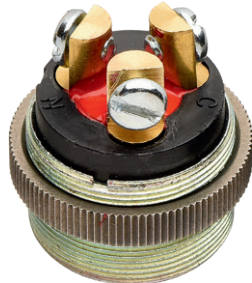

TS
Three flat bar terminals with #6-32 pan head screws at right angle

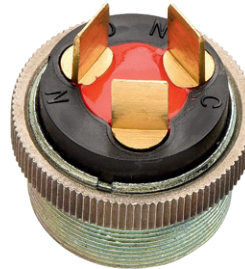

TB
3 standard 1/4" terminals accept arc-less (or equal) female quick connect terminals



DN
DIN Male Plug "F" Set Only Except "C", "K" & "F" Set on P605 Series Units

For L and U Electrical Interfaces

2 or 3 wire pigtail furnished in 12" length
Standard-supplied #20 AWG Insulated with polyvinyl chloride - 300 volts.

COLOR CODE:

- Black - Common
- White - N.O.
- Red - N.C.

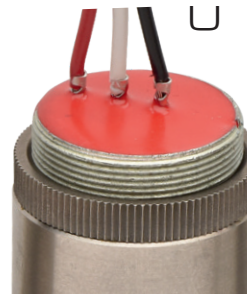
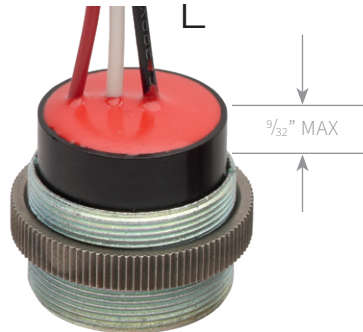

DN Pin-out:

- 1 = Common
 - 2 = N/C
 - 3 = N/O
- Other Pin-outs on request

"M" Interface Quick-Disconnect 3-Pin Connector

This interface is rated as environmentally resisting. It is intended for use where the connector will be subjected to heavy condensation and rapid changes in environmental temperature or pressure. This connector is equivalent to MS3102E-10SL-3P. Applicable to models shown below only.

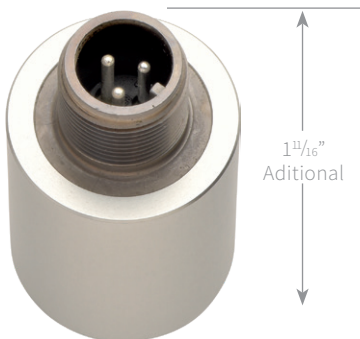

"M" Interface

P117, J705, J205, P605
"F" Set Only Except "C"
"K" and "F" Set on P605

MS3106E

Connectors - All Models
With "M" Interface

Interface Options

Optional Electrical Interfaces
Available for Model P88

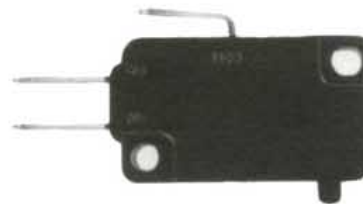

TB
1/4" (TB)
Blade terminals
UL Recognized
CSA Listed

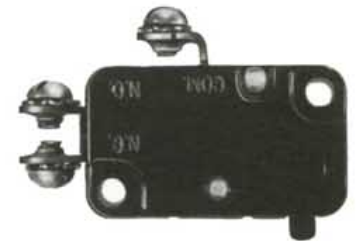

TS
Screw Terminal
UL Listed
(except 25 amp)
CSA Listed

Order from: **C A Briggs Company**; 622 Mary Street, Suite 101 - Warminster, PA 18974
Phone: 267-673-8117 - Fax: 267-673-8118; E-Mail: Sales@cabriggs.com - www.cabriggs.com

Popular Options:

- **SPECIFIC RESET POINT RANGE** – (Calibrated Switch)
- **PIGTAILS** – Standard, Non-jacketed (“L” Interface)
12” long included in price, longer lengths available
18 AWG, 20 AWG Wire in various colors
- **PIGTAIL WITH PVC JACKET** (“L” Interface)
12” length, longer lengths available
- **UL and/or CSA – Consult Factory**
Some product is covered by UL-CSA approval under the following file numbers: UL E 109178 – CSA LR62173 – P88, P117, W117, P119, J205.
UL E 123402 – CSA LR87500 – Wiring harness
- **PIN RECEPTACLE** – AMP 60598-4 or equal
Three per set (“T” interface)
- **VOLTAGE SPIKE ARRESTOR** – AC/DC Voltage, SPST/SPDT Switches
- **BAR CODING**
- **R/C CIRCUITS FOR CURRENT BELOW 10mA**
- **O-RINGS (J205, P605, J705 only)**
Special materials upon request
- **ROLL STAMPING/STENCILING**
- **COMPUTER DIAGNOSIS CAPABILITY**
- **SHRINK TUBING**
- **CONVOLUTED CONDUIT**
- **LABELING**
- **TEFLON TAPE** – Available on NPT Fittings
- **THREAD LOCKER** – Available on all Fittings

Adapters:

Models P100, P119 and J705 are available with optional port thread adapters.



1/8” NPT to 1/4” NPT



1/8” NPT to 7/16-20 SAE



1/8” NPT to 9/16-18 SAE

Fittings:

Most models can be obtained with a variety of fittings. Some common fittings are shown below. Please specify when ordering.



1/8 NPT Fitting
(Optional for P605)



1/4 NPT Fitting
(Optional for P117, P119 J205, W117)



7/16-20 Thread Fitting
(Optional for P117, J205)

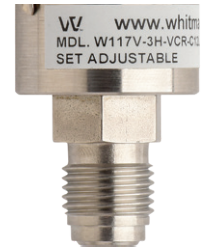

1/4” VCR Fitting
(Optional for P117, W117, J205)

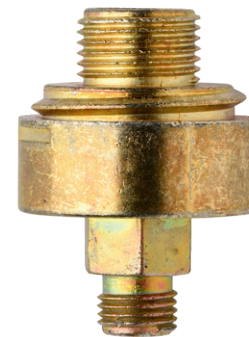

1/2-20 SAE Fitting with Optional O-Ring
(Optional zinc diecast for P90)
(Optional stainless steel for P95)

Order from: **C A Briggs Company**; 622 Mary Street, Suite 101 - Warminster, PA 18974
Phone: 267-673-8117 - Fax: 267-673-8118; E-Mail: Sales@cabriggs.com - www.cabriggs.com

Set Point Adjustments and Wiring Instructions

SET POINT ADJUSTMENTS

PRESSURE SWITCHES

PRESSURE SET POINT ADJUSTMENT-JAM NUT STYLE ADJUSTING RING MODELS P100, P117, W117, P119, J205, J705 – K OR C SET.

The K & C designs are readily adjustable throughout their prescribed range by loosening the knurled locking ring. Turning the electrical switch clockwise will lower the set point, turning it counterclockwise will increase the set point. When desired set point is reached, the assembly is locked again by tightening the knurled locking ring.

Entire adjustable range may be covered by rotating approximately 250° each side of the mean.

The knurled locking ring requires very little effort to establish a reliable locked position. By placing a wrench on the fitting hex to hold switch body in position, grip the knurled locking ring with pliers and turn counterclockwise to loosen or clockwise to tighten. Only a slight snug is required to lock in position.

VACUUM SET POINT ADJUSTMENT – VACUUM MODELS

To lower set point turn electrical switch counterclockwise. To raise set point turn electrical switch clockwise.

PRESSURE SET POINT ADJUSTMENT – MODEL P605

Slide spring clip cover down past adjusting ring window. Insert .093 inch dia. pin into adjusting ring radial hole. Pushing the pin to the right (counterclockwise) will lower the set point: to the left (clockwise) will raise the set point. Align center of pin holes to the desired pressure. When desired set point is reached, remove pin and slide up the cover to close the adjusting ring window.

PRESSURE SET POINT ADJUSTMENT MODEL P88 K OR C SET

The standard field adjustable versions of the Guardian P/V Model P88 are easily adjusted throughout the prescribed pressure range by aligning the top of the knurled adjusting nut with the desired pressure setting indicated on the adjacent range scale.

PRESSURE SET POINT FOR ADJUSTABLE SWITCHES

All switches are easy to adjust. First, loosen the knurled locking ring. Now, set the sliding gauge pointer to the desired pressure point. Tighten the locking ring and the pressure (vacuum) switch is locked and ready to use.

NOTE: Little effort is required to establish a reliable locked position. If tools are used, place a wrench on the hex nut under the switch to hold the switch body in place; then grip the knurled locking ring with pliers to tighten or loosen as desired.

Loosen knurled ring, set pointer to desired pressure and tighten ring to hold in position.



Knurled Locking Ring

On P605 Models, insert the pin (provided) into the adjusting ring and align center of pin holes to the desired pressure.



WIRING INSTRUCTIONS

MODELS P90, P95, P100, P117, P119, J205, J705, P605, W117

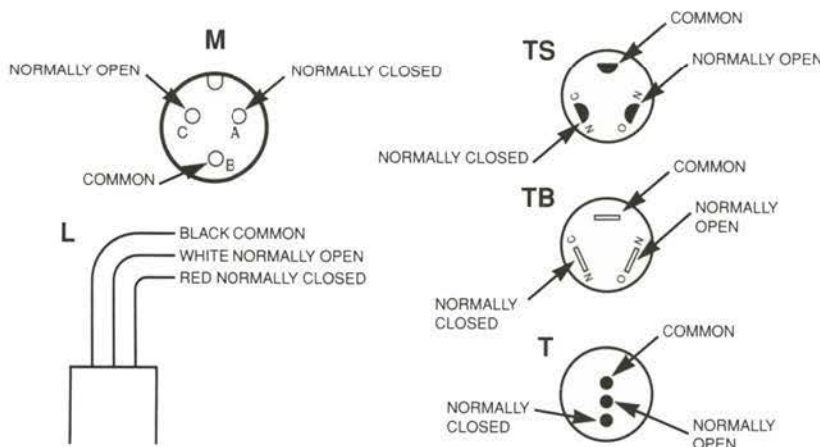

MODEL P88

Type TB [Terminal Blades]

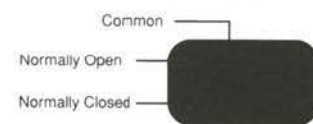

Type TS [Terminal Screws]

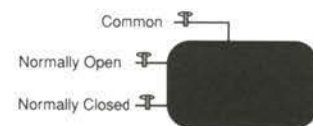

Order from: **C A Briggs Company**; 622 Mary Street; Suite 101 - Warminster, PA 18974
Phone: 267-673-8117 - Fax: 267-673-8118; E-Mail: Sales@cabriggs.com - www.cabriggs.com

ACCURACY - The limit of deviation from the set point of a pressure or vacuum switch. It is usually defined in either pounds per square inch, or percentage of full scale.

ACTUATION POINT - See SET POINT. **ACTUATION VALUE** - The difference between the set point and the reset point.

ADJUSTABLE RANGE - The range within which the switch can be set from the lowest to the highest point, usually expressed in PSI, inches of mercury or PSIA.

BUOYANT FORCE - A body submerged in fluid is pushed or buoyed up by a force equal in magnitude to the weight of the displaced fluid. Buoyancy is dependent on both weight and shape of the float.

CRUSH PRESSURE - The maximum pressure to which the floats may be exposed without deformation. Tanks containing liquids are frequently pressurized. Crush pressure varies with the materials of construction, wall thickness, shape and desired density.

DEADBAND - The difference between the increasing and decreasing readings when the switch is operated between set point and reset point.

DIFFERENTIAL - The mechanical motion lost within the electrical switch element while it reverses itself. This is usually greater in high amperage switches than in low amperage switches.

ELECTRICAL RATINGS - The reed switches are specified as VA (Volt Amps) or Watts. See Table A.

ELECTRICAL SWITCHING ELEMENT - Opens or closes an electrical circuit in response to movement from the pressure or vacuum sensing element. Single pole, double throw (SPDT) snap action switches are standard, may be used as single pole, single throw (SPST). NO/NC circuitry is selectable, but it must be specified at order time.

FLOAT - The liquid level sensor, the portion of the level switch that rises and falls with the changes in the level of a liquid. The float contains the magnet used to operate the reed switch. It is made of various materials and densities to achieve a material compatibility and to be able to float in liquids with various specific gravities.

FORM A SWITCH - A single pole single throw electrical switch - the preferred electrical switch for liquid level devices.

FORM C SWITCH - A single pole double throw electrical switch.

HYSTERESIS - The difference in pressure or vacuum switch response to increasing or decreasing pressure or vacuum.

INTERFACE - The surface between two liquids that have different Specific Gravities, e.g. oil floating on water.

INTERFACED - A float whose buoyancy has been adjusted to float at the interface of the two liquids that have different Specific Gravities.

LIQUID LEVEL SWITCH - An electromechanical device that opens or closes an electrical circuit in response to a change in the level of a liquid.

LIQUID LEVEL SWITCH OPERATION - A float containing a permanent magnet riding on the surface of a liquid. The motion of the float is guided by a stem. The stem contain a reed switch that is actuated by the magnet in the float.

MOISTURE PROTECTION - Our liquid level switches are sealed with potting compound. The only path for liquid to the electrical switch would be through the wires. If the wires are terminated in an appropriate manner (e.g. - NEMA VI connectors), the level switch will meet or exceed NEMA VI.

NEMA VI - A device suitable for submersion.

NORMALLY CLOSED SWITCHING ELEMENT - Current flows through the switch until it is broken by a pressure or vacuum change.

NORMALLY OPEN SWITCHING ELEMENT - No current flows through the switch until contact is made by a pressure or vacuum change.

PRESSURE, ABSOLUTE - A pressure scale based on PSIA "0" or a perfect vacuum.

PRESSURE, AMBIENT - The pressure immediately surrounding a pressure switch. It is usually, but not necessarily, atmospheric gauge pressure.

PRESSURE, ATMOSPHERIC - The pressure caused by the actual weight of the earth's atmosphere. At sea level, atmospheric pressure equals 14.7 psi, 30 inches of mercury, or 408 inches of water, above absolute "0" ("0" PSIA).

WHITMAN VALUE

High Quality Switches, Fully Customizable, with an Unrelenting Focus on Superior Service

Whitman Controls has been a leader in the pressure, vacuum, and liquid level switch industry for over 40 years. The Whitman Value is built on our differentiated offering of high quality switches, and the ability to deliver product to EXACT customer specifications in two weeks or less. Off the shelf switches limit an application's functionality and versatility – Why choose a competitor switch that results in inferior performance? We take into account your application and media environment, as well as all desired specifications to design a switch that will meet performance needs and exceed your expectations. Quality switches, designed to customer specifications in two weeks or less, with an unrelenting focus on superior service - Together they add up to the Whitman Value.

ISO 9001 Certified – We Hold Ourselves, and Our Products, to the Highest Standards

Whitman Controls is ISO 9001:2015 Certified, which gives our customers the confidence that we hold our internal processes, and products, to the highest standards of quality and rigorous testing requirements. You can be confident that the product you receive has met all necessary regulatory requirements and will outperform your desired expectations.

Experience and Knowledge, That's Invaluable.

Whitman Controls directs its years of design and manufacturing experience toward providing value-added services to our customers. These services can help you lower costs and increase efficiency. Our engineering team will work intimately with you and your team to design a switch that will maximize application performance no matter what the environment. In addition, our exceptional mechanical abilities allow us to perform additional assemblies and deliver more complete tested systems and subassemblies.

Diversified Product Offering – More Choices and More Savings.

We offer the most extensive pressure, vacuum, and liquid level switch offering in the industry. What does this mean for you? The ability to identify a switch that is suited perfectly for your application at a price that doesn't break your budget. At Whitman, we are constantly evaluating our input prices to identify savings we can pass along directly to the buyer. And we do all of this without sacrificing performance and quality.

Numerous Choices and Additional Options – Have it your Way.

Need additional wire on top of the 12" standard offering? Looking for a 1/4" NPT fitting instead of 1/8" NPT? Need Teflon tape or Loctite Vibraseal on your fitting? These are just a few of the numerous additional options that are available to customers on all our switch offerings. You have a need and we have an answer. All our switches can be customized to meet any end-user requirements.

At the Other End, Whitman Can Handle Wire Harness Assemblies Too.

As a UL and CSA approved harness assembly house, Whitman can do your next level of assembly. With our capabilities we can provide "value-added" benefits top to bottom. Whitman can guarantee leak free subassemblies and can handle a wide variety of switch mounts in customer designed systems. From T's to elbows, we will purchase and assemble parts and switches to your specifications.

Plus we can do it all at a price that will save you money. Call or email us today and we will give you a quotation on your assembly project.

Quality products, fully customizable, with a commitment to superior service. Together they add up to the Whitman Value.



Order from: **C A Briggs Company**; 622 Mary Street; Suite 101 - Warminster, PA 18974
Phone: 267-673-8117 - Fax: 267-673-8118; E-Mail: Sales@cabriggs.com - www.cabriggs.com



Order from: **C A Briggs Company**
622 Mary Street; Suite 101; Warminster, PA 18974
Phone: 267-673-8117 - Fax: 267-673-8118
Sales@cabriggs.com - www.cabriggs.com