

PDW90 Point to Multi-Point Wireless

Installation Guide



Thank you for your purchase of the PDW90 Point-to-Multipoint Wireless Process Signal System.

This installation guide will briefly describe some common setup procedures and best practices for this device.

This guide includes:

| | |
|--|----|
| Important Information..... | 2 |
| Available Accessories..... | 2 |
| Basic Wiring of Base Station..... | 3 |
| Basic Wiring of Field Units..... | 4 |
| Wireless Installation..... | 5 |
| Using PDW Manager..... | 6 |
| Connecting the Wireless Field Units.... | 7 |
| Configure Field Units' Analog Inputs.... | 8 |
| Base Station Analog Output..... | 9 |
| Troubleshooting Guide..... | 10 |
| How to Contact Precision Digital..... | 12 |

Additional information about the PDW90 can be found in the instruction manual included on the CD that came with this product or available at our website, www.predig.com.

The PDW90 is programmed using *PDW Manager*. This software is included on the CD or available for download at www.predig.com/PDWManager.



Order from: **C A Briggs Company**

622 Mary Street; Suite 101; Warminster, PA 18974

Phone: 267-673-8117 - Fax: 267-673-8118

Sales@cabriggs.com - www.cabriggs.com

Important Information



Read complete instructions and product labels and follow all instructions and requirements listed on the labels for installation or service.



Installation and service should be performed only by trained service personnel. Service requiring replacement of internal sub-components must be performed at the factory.



Wiring connectors are accessed by unscrewing and removing the enclosure cover. To access electrical connectors, remove the two securing screws and then remove the electronics module. Connectors are on the rear of the electronics module.

Available Accessories

Optional accessories for the PDW90 include solutions for long distance wireless transmission, convenient mounting kits, and wireless surveying tools.

Directional Antennae

High gain directional antennae allow the PDW90 wireless units to broadcast wireless signals much farther with a clear line of sight.

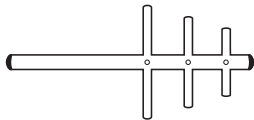

PDA3900

Antenna Extension Cables

Use antenna extension cables to mount the device antenna high above the ground in order to clear obstacles that could hinder signal strength.

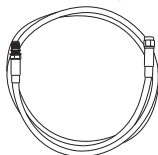

**PDA3120 &
PDA3140**

Repeaters

For especially long range applications, wireless repeater modules are available.



PDW30-RNA

Order Accessories

To order accessories for the PDW90, please contact our sales team at:

Phone: (800) 343-1001 or (508) 655-7300

Fax: (508) 655-8990

Email: sales@predig.com

Web: www.predig.com

Basic Wiring of Wireless Base Station

All wiring of the PDW90 base station may be performed by opening the enclosure door panel. The image below shows the electronics board of a fully loaded base station with four relay modules, four digital I/O modules, four analog input modules and four analog output modules.

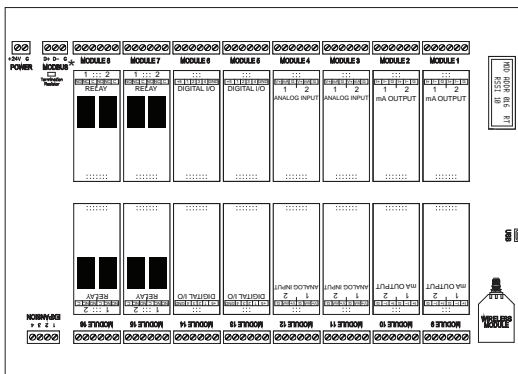

*Note: Modbus® I/O is covered in the instruction manual.

Analog Input Wiring

Each analog input module has two input channels which may be wired for 4-20 mA, 0-10 V, 0-5 V, or 1-5 V inputs. Channel inputs are independently selectable using *PDW Manager*.

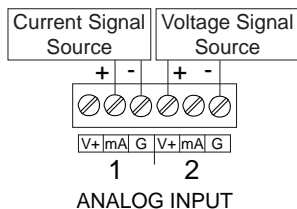

Digital Input/Output Wiring

Each digital I/O module has four channels which may be wired as either inputs or outputs. All digital connections are referenced to ground; digital input connections have an internal pull-up resistor.

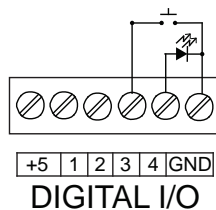

Analog Output Wiring

Each 4-20 mA output module has two output channels. These may be wired to a self powered 4-20 mA input device or devices which require a power supply.

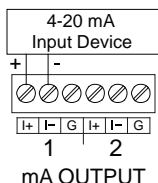

Relay Wiring

Each relay module has two channels. Each relay's C terminal is common only to the normally open (NO) and normally closed (NC) contacts of the relay.

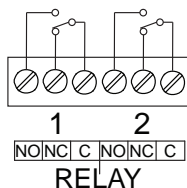

Basic Wiring of Wireless Field Units

In order to wire the wireless field units, it is necessary to unscrew their covers and remove their electronics modules. Screw terminals are located on the reverse side of the electronics modules. Wires should be run through the conduit entry holes at the rear of the device housing. The following diagram shows screw terminal locations on the electronics module.

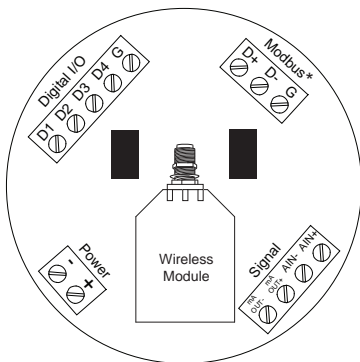

*Note: Modbus® I/O is covered in the instruction manual.

Analog Input Wiring

The analog input may be either 4-20 mA, 0-10 V, 0-5 V, or 1-5 V. The appropriate input type must be programmed for each unit.

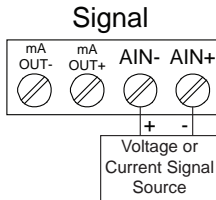

Digital Input/Output Wiring

The primary unit settings determine whether a digital connection is an input or an output.

Note: Each connection may be set independently as either an input or an output. In the diagram below, D4 & D3 are inputs and D2 is an output.

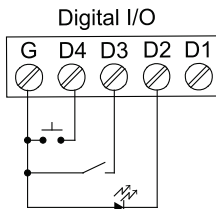

Analog Output Wiring

The output signal is 4-20 mA regardless of the input type on the other wireless module.

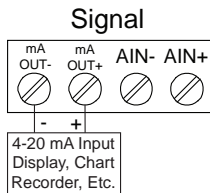

Device Power

Make sure that the power supplies being used to power each wireless unit can provide between 12 and 28 VDC.

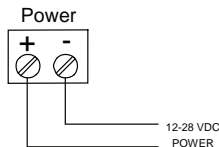

Wireless Installation

The diagram below shows a typical PDW90 installation. Multiple transmitters are outputting analog signals to wireless field units. The analog signals are being wirelessly broadcasted to the PDW90 base station which then sends 4-20 mA signals to the destination devices. This guide will show you how to configure this type of installation. For alternate installation options or more setup detail, please consult the PDW90 instruction manual.

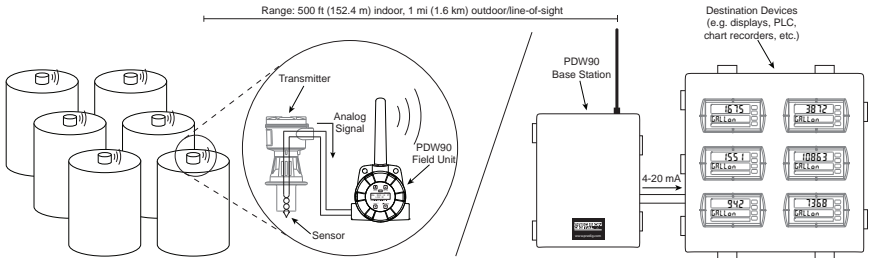

Installation Tips

Any wireless network can be negatively affected by certain factors, such as physical obstacles and improper equipment placement. Please review the wireless installation tips below in order to avoid some common installation mistakes.

Note: As is the case with any equipment installation, a little leg work at the beginning can go a long way. Take the time to verify that the wireless units can communicate with each other from the desired mounting locations prior to installation.

Obstacles

Check that there are no obstacles blocking the wireless signal path. Do not install the wireless units with their antennae abutting pipes or other metal objects.

Note: Make sure to install as high as practicable, above the height of any known obstacles.

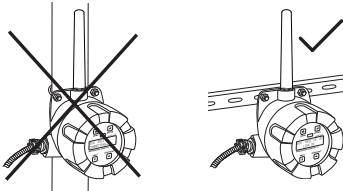

Orientation

The antennae broadcast in a horizontal pattern. Make sure that the units are positioned on a parallel plane.

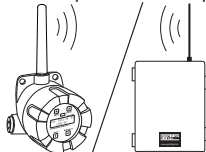

Signal Noise

Wireless networks can be impeded by other wireless signals and electrical noise. In order to limit signal noise from other 900 MHz wireless signals, ensure vertical separation of at least 26 inches (66 cm).

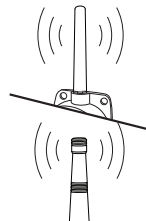

Environmental Interference

Intermittent environmental factors, such as rain, snow, and humidity, can affect wireless reception. Make certain that the *received signal strength indicator (RSSI)* on the device is at least 5 in clear conditions in order to account for non-optimal conditions.



Using PDW Manager

The PDW90 is programmed via a micro USB connection using *PDW Manager* on a computer. *PDW Manager* is available on the included CD or online at www.predig.com/PDWManager. Once the software is running, power the base station using a 24 VDC power supply and connect the device to the PC using the provided USB cable.

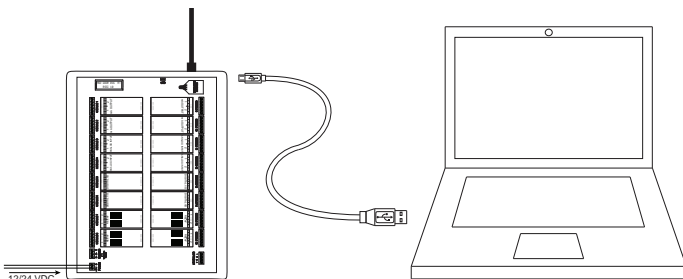

The PC will automatically install the appropriate device drivers. Once this has completed, the device will appear in the *Device* list at the top of the *PDW Manager* window. Click *Connect*.

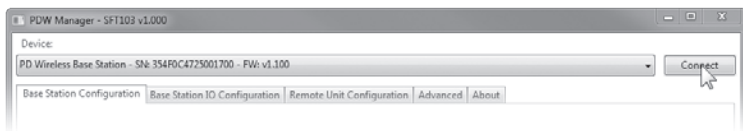

PDW Manager will display the following screen once data has been read from the base station. Use the tabs at the top to navigate between settings screens.

Base Station Configuration

Configure basic device settings, such as name, network ID, and Modbus settings.

Base Station IO Configuration

Change settings for attached I/O modules, such as analog inputs and outputs, digital I/O, and relays.

Remote Unit Configuration

Connect remote field units and configure their I/O settings.

Advanced

Modify advanced settings such as network encryption or reset the base station to factory defaults.

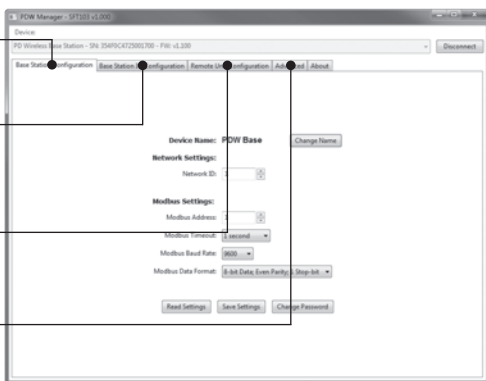

Connecting the Wireless Field Units

The first thing that must be done when programming the PDW90 is connect all of the wireless field units to the base station. Configuration of the base station is accomplished using the *PDW Manager* software, while the individual field units may be programmed using the device buttons which are accessed by unscrewing the enclosure cover.

Note: All units must be powered on in order to complete these steps.

1

- Using *PDW Manager*, on the *Base Station Configuration* tab, enter a unique network ID into the *Network ID* field.

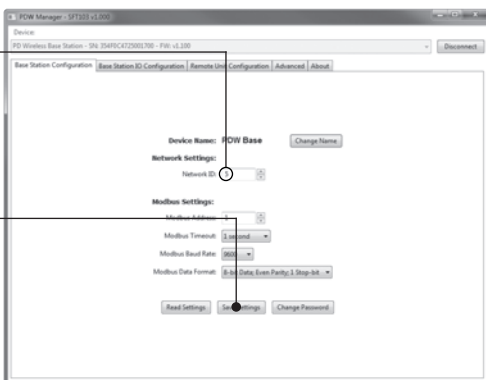

2

- Click the *Save Settings* button to save the network ID to the PDW90 base station.

3

- On each field unit, press **↑** to access the device menu.
- If it is necessary to change the network ID, press **↵**. Press **⇒** to change which digit is selected and press **↑** to increment the selected digit. Press **↵** when done.



4

- Press **↑** to select the **MODBUS ADDRESS** menu and press **↵** to edit.
- Using **⇒** to change which digit is selected and press **↑** to increment the selected digit, assign each field unit a unique Modbus address. Press **↵** when done.
- Press **↑** to return to run mode.



Note: The field units must be assigned the same network ID as the base station in order to connect with it.

5

- Using *PDW Manager*, on the *Remote Unit Configuration* tab, select each available field unit from the *Unassociated Remote Units* list and click the *Add to Client List* button.



Configure Field Units' Analog Inputs

Once the field units have been connected to the base station, they may be programmed wirelessly using *PDW Manager*. Each field unit must be programmed independently to accept the appropriate analog input.

1

Click the *Remote Unit Configuration* tab.

2

Select the appropriate field unit from the *Connected Clients* list.

3

Click the *Analog Input* tab.

4

Select the appropriate analog input type from the *Analog Input Mode* drop-down list.

5

Click the *Save Configuration* button.

6

Repeat steps 2-5 for each additional field unit.

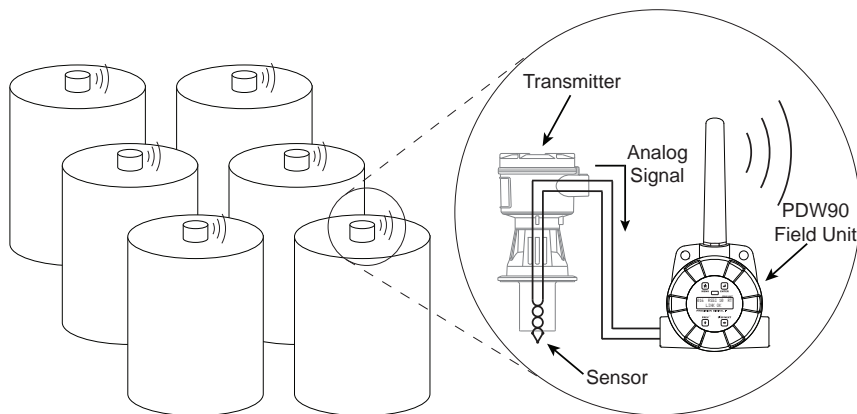
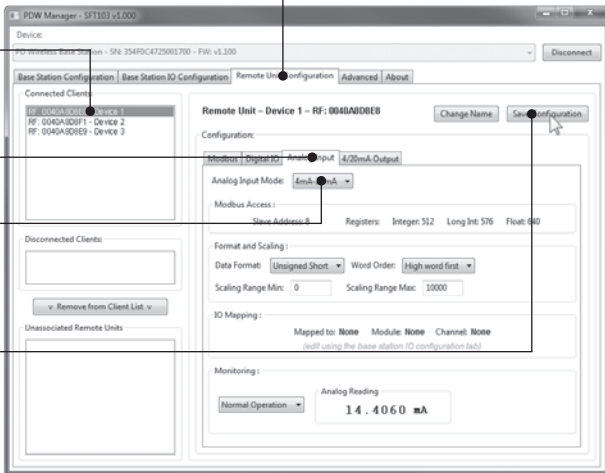

Base Station Analog Output

Once the field units have been programmed to accept an analog input, the 4-20mA analog output modules on the base station may be configured to retransmit the signal received from the field units.

1

Click the *Base Station IO Configuration* tab.

2

Select the appropriate I/O module from the *IO Modules* list.

3

Select the module channel to which the device is wired.

4

Select *Enable* from the *Analog Output Mode* drop-down.

5

Select *Map to Remote Analog Input* from the *IO Mapping* drop-down list.

6

Click the *Choose Mapping* button and select a field unit to associate with this module.

7

Click *Save Module Configuration*.



8

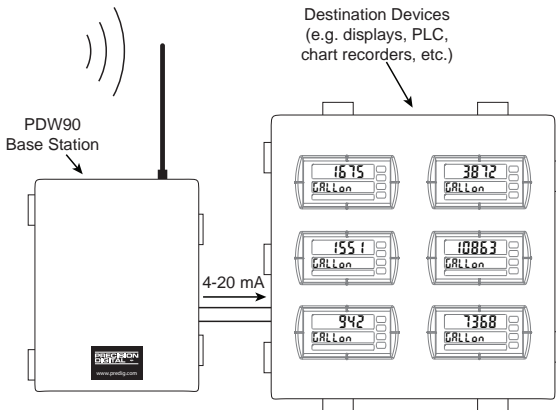
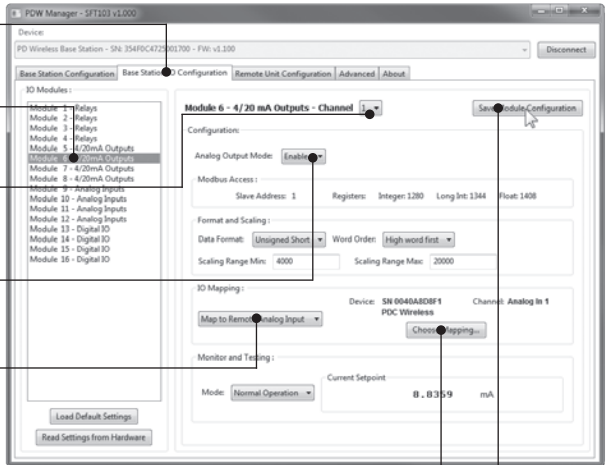

Repeat steps 2-7 for each additional 4-20mA Output module.

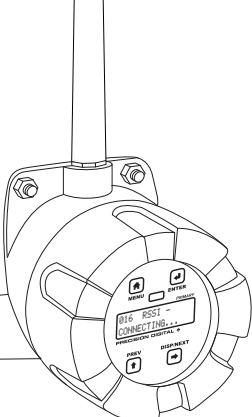

Troubleshooting Guide

If you are experiencing difficulties with your wireless installation, consult the troubleshooting steps listed below. For best results, identify the symptoms of the problem you are having and attempt all of the corrective actions listed for the particular symptom.

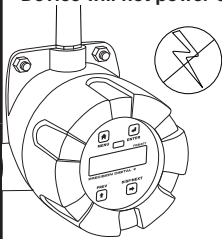
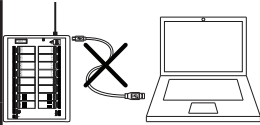
| Symptom | Possible Cause | Corrective Action |
|---|---|--|
| Devices will not connect.  | Devices have mis-matched network IDs. | <ul style="list-style-type: none"> • Devices will not connect if they do not have the same network ID. Verify that all devices share the same network ID by following the directions on page 7. |
| | Devices are out of range or there are obstacles blocking the wireless path. | <ul style="list-style-type: none"> • Bring devices closer together to see if it alleviates the issue. Field units will display LINK OK if they are connected. If devices connect, consider placing closer together permanently, removing any obstacles, or mounting higher. • Ensure antennae are on parallel plane. Devices that are vertically separated will not have as strong of a connection. • If communicating over distance of miles, consider installing high gain directional antenna. |
| | Multiple wireless devices in the area with the same ID. | <ul style="list-style-type: none"> • If there are multiple PDW90 or PDW30 wireless systems, verify that each has its own unique network ID. |
| Intermittent signal issues.  | Signal is too poor. | <ul style="list-style-type: none"> • Check the RSSI of the device. If signal is too low, consider moving devices closer together, clearing obstacles in wireless path, or mounting devices higher. • Ensure devices are on parallel plane. • If communicating over distance of miles, consider installing high gain directional antenna. |
| | Temporary obstacles are blocking the wireless path. | <ul style="list-style-type: none"> • Temporary obstacles, such as large trucks or heavy equipment, can interfere with wireless path. Consider moving wireless units higher or to an area with less traffic. |
| Destination device reads out of range, zero, or incorrect.  | Wireless device has mismatched input type. | <ul style="list-style-type: none"> • Make sure that input type on the field unit is correct for the analog input being used. Options are 4-20 mA, 0-10 V, 0-5 V, or 1-5 V. |
| | Destination device is not scaled properly. | <ul style="list-style-type: none"> • Destination device must accept 4-20 mA signal and be scaled to properly display the signal. Check the manufacturer's instruction manual for how to do this. |
| | Signal connections are improperly wired. | <ul style="list-style-type: none"> • Double check to make sure all of the signal connections are properly wired to all devices. Check wiring diagrams on pages 3-4. |

| Symptom | Possible Cause | Corrective Action |
|--|--|---|
| <p>While trying to connect field units using <i>PDW Manager</i>, none appear in the <i>Unassociated Remote Units</i> list.</p>  | Devices have mismatched network IDs. | <ul style="list-style-type: none"> • Devices will not connect if they do not have the same network ID. Verify that all devices share the same network ID by following the directions on page 7. |
| | Multiple field units have same Modbus address. | <ul style="list-style-type: none"> • If multiple field units share the same Modbus address it will cause a conflict. Verify that all field units have unique Modbus addresses. |
| | Devices have differing encryption settings. | <ul style="list-style-type: none"> • Encryption settings must be the same on all devices. Use <i>PDW Manager</i> to verify the encryption settings on all devices. |
| <p>Device will not power on.</p>  | Not enough voltage is coming from the power supply. | <ul style="list-style-type: none"> • The base station requires at least 24 VDC in order to power on. Field units require at least 12 VDC. Check that the power supplies are providing enough voltage to the devices and that there are not too many devices drawing from the supply. |
| | Devices are improperly wired. | <ul style="list-style-type: none"> • Check to make sure all power connections are properly wired to all devices. Check wiring diagrams on page 3. |
| <p>Device will not connect to PC via USB</p>  | Device is not powered. | <ul style="list-style-type: none"> • The base station and field units must be powered by a 24 VDC supply in order for the PC to recognize them. Power the device you are trying to connect and try again. |
| | Software version is outdated. | <ul style="list-style-type: none"> • Check that you are running the latest software version. The latest version of <i>PDW Manager</i> can be downloaded at www.predig.com/PDWManager |
| | USB cable or port is faulty. | <ul style="list-style-type: none"> • Try connecting the wireless device to a known good USB port using a known good micro USB cable. Any standard USB A to micro USB B cable should work. |
| <p>Other Issue</p>  | <p>If you are experiencing a symptom not listed here, or the suggested troubleshooting steps do not alleviate your problem, please contact technical support at:</p> <p>Phone: (800) 610-5239 or (508) 655-7300</p> <p>Fax: (508) 655-8990</p> <p>Email: support@predig.com</p> <p>Web: www.predig.com</p> | |

How to Contact Precision Digital

For Technical Support, please

Call: (800) 610-5239 or (508) 655-7300

Fax: (508) 655-8990

Email: support@predig.com

For Sales Support or to place an order, please

contact your local distributor or

Call: (800) 343-1001 or (508) 655-730 0

Fax: (508) 655-8990

Email: sales@predig.com

For the latest version of this manual please visit

www.predig.com

Order from: **C A Briggs Company**

622 Mary Street; Suite 101; Warminster, PA 18974

Phone: 267-673-8117 - Fax: 267-673-8118

Sales@cabriggs.com - www.cabriggs.com



PRECISION DIGITAL CORPORATION

233 South Street • Hopkinton MA 01748 USA

Tel (800) 343-1001 • Fax (508) 655-8990