

Operating Instructions
for
Nitrogen Filled Thermometers

Model: TNS/ TNF



Order from: **C A Briggs Company**
622 Mary Street; Suite 101; Warminster, PA 18974
Phone: 267-673-8117 - Fax: 267-673-8118
Sales@cabriggs.com - www.cabriggs.com

1. Contents

1. Contents.....	2
2. Note	3
3. Instrument Inspection.....	3
4. Regulation Use.....	3
5. Operating Principle.....	4
6. Electrical Connection (Option).....	4
6.1. Contacts.....	5
6.2. Switching Function Contacts.....	7
7. Installation	8
8. Maintenance and Storage	8
9. Technical Information.....	9
10. Order Codes	10

Manufactured and sold by:

Kobold Messring GmbH
Nordring 22-24
D-65719 Hofheim
Tel.: +49(0)6192-2990
Fax: +49(0)6192-23398
E-Mail: info.de@kobold.com
Internet: www.kobold.com

2. Note

Please read these operating instructions before unpacking and putting the unit into operation. Follow the instructions precisely as described herein.

The devices are only to be used, maintained and serviced by persons familiar with these operating instructions and in accordance with local regulations applying to Health & Safety and prevention of accidents.

When used in machines, the measuring unit should be used only when the machines fulfil the EWG-machine guidelines.

3. Instrument Inspection

Instruments are inspected before shipping and sent out in perfect condition.

Should damage to a device be visible, we recommend a thorough inspection of the delivery packaging. In case of damage, please inform your parcel service / forwarding agent immediately, since they are responsible for damages during transit.

Scope of delivery:

The standard delivery includes:

- Nitrogen Filled Thermometer, model: TNS/TNF
- Operating Instructions

4. Regulation Use

Any use of the Nitrogen Filled Thermometer, model: TNS/TNF, which exceeds the manufacturer's specifications, may invalidate its warranty. Therefore any resulting damage is not the responsibility of the manufacturer. The user assumes all risk for such usage.

5. Operating Principle

The measuring system of the gas pressure thermometer comprises probe, capillary tube and Bourdon tube in a casing. These parts form a unit. The complete measuring system is filled with pressurised nitrogen. A change in temperature causes a change in inner pressure in the immersion shaft. The resulting deflection of the Bourdon tube is transferred to the pointer through a pointer element.

For the model TNF, the display and probe are connected by a capillary tube separated by a distance up to 100 m.

A version filled with glycerine is available as an option for service at measuring points exposed to strong vibrations. The fill dampens the measuring system when exposed to mechanical vibrations and thus enables steady indication; it also provides good lubrication for moving parts.

We recommend our robust aluminium casing for rough field service conditions.

These thermometers can also be used with aggressive measuring substances when fitted with a suitable thermowell.

6. Electrical Connection (optional)

The electrical wiring diagram for the incorporated 2-wire transmitter with 4...20 mA output is given below. For all electrical parameters please see section 9. Technical Information: Transmitter.

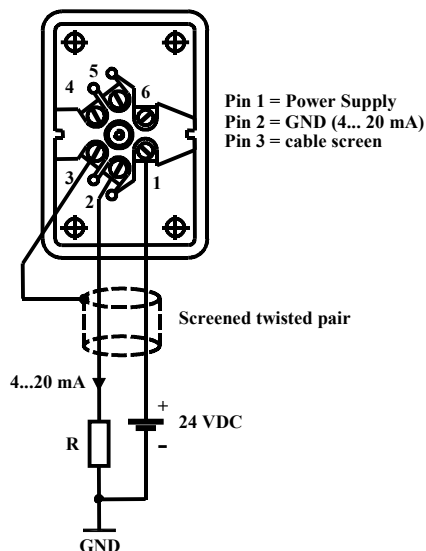

6.1. Contacts

(only for case diameters 100 and 160 mm)

Description

Electromechanical and electronic limit monitors serve to open and close electrical switching circuits depending on the position of the instrument display. They are suitable for fitting in casings with 100, 160 mm Ø.

The limit values are adjusted from outside with a setting lock. The limit monitor is set with a detachable key to the value at which the switching operation is to be carried out.

The construction of the limit monitor is such that the instrument can continue operating past the setting pointer after successful contact operation.

The maximum setting range is approximately 270 degrees. Ambient temperatures of –20 °C to +70 °C have no effect on the reliability performance.

We strongly recommend the use of our contact protection relays in applications with high breaking capacities or vibrations, or for service in damping liquids (oil). These relays have been specially designed for electromechanical limit monitors and their use is mandatory.

The following contacts are available:

- Slow-action contacts
- Magnetic spring contacts
- Inductive contacts

6.1.1. Magnetic spring contacts

Magnetic spring contacts are suitable for service under almost all operating conditions. They are almost completely insensitive to vibrations. The contact pin carrier of the setting pointer is fitted with an adjustable magnet which pulls in the wiper shortly before the set value is reached. Arcing is thus avoided and the pin is prevented from being scorched. Because the magnetic force becomes effective during the switching operation with this construction, the setting pointer must be advanced or retarded by a differential gap of approximately 3–6% of full scale value.

Switching voltage: max. 250 VAC/VDC
Breaking capacity: max. 30 W/50 VA
Switching current: max. 0.6 A
with standard contact material silver-nickel (Ag 80 Ni20)

Others on request.

6.1.2. Slow-action contacts

These contacting devices switch free of delay in the same way as the motion of the actual-value pointer. They should be used where no contact loading is required and the instruments are not exposed to vibrations. Due to sparking, the contacting devices should not be used where there is a danger of explosion. Care should also be taken that the contacting devices are not exposed to the effects of aggressive vapours.

Switching voltage: max. 250 VAC/VDC
Breaking capacity: max. 10 watt / 18 VA
Switching current: max. 0.6 A

with standard contact material silver-nickel (Ag 80 Ni20)

6.1.3. Inductive contacts according to DIN 19234 (Namur)

The inductive contact device comprises mainly the control head (initiator) attached to the setpoint pointer with its completely assembled encapsulated electronics and mechanical assembly with moving control vane. The control vane is moved by the instrument pointer (setpoint pointer). The control head is supplied with DC voltage.

When the control vane is immersed in the air gap of the control head, its inner resistance increases (damped condition, the initiator is high-resistive). The resulting change in current intensity is the input signal for the switching amplifier in the control unit.

Inductive contacts are suitable for service where explosion protection and high reliability and switching rate, that is, long service life, are required.

Advantages of the inductive contact device:

- Long service life with non-contact switching
- Negligible reaction on the display
- Insensitive to aggressive environments (encapsulated electronics)
- Explosion protection, with control unit for service in zone 1 and 2 areas

Nominal voltage: 8 V_{DC} (R_i = 1 kΩ)







6.1.4. Ex-protection

Thermometers with inductive contacts and external control unit can be used in hazardous areas (zone 1 and 2). The necessary control unit should be installed outside the ex-area.







Please refer to our brochure Z2 for details on control units.

6.2. Switching Function of Contacts

Magnetic spring contacts/slow-action contacts

Limit monitor with one contact			
Switching operation	Switching function (when the limit value is exceeded)	Order code Magnetic spring contact	Order code Slow-action contact
	Contact closes	..M10	..S10..
	Contact opens	..M20	..S20..
	Contact switches over, that is, contact opens contact closes	..M30	..S30..
Limit monitor with two contacts			
	First and second contact closes	..M11	..S11..
	1. Contact closes 2. Contact opens	..M12	..S12..
	1. Contact opens 2. Contact closes	..M21	..S21..
	First and second contact opens	..M22	..S22..

Inductive contacts

Limit monitor with one contact			
Switching operation	When the thermometer pointer moves clockwise and when the set limit value is exceeded it causes the following action:	Control action	Order code inductive contact
	moves the control vane out of the control head	Control circuit is closed	..I10..
	moves the control vane into the control head	Control circuit is opened	..I20..
Limit monitor with two contacts			
	moves the control vane of the first and second contact out of the control head	Control circuits are closed	..I11..
	moves the control vane of the first contact out of the control head - moves the control vane of the second contact into the control head	Control circuits are closed	..I12..
	moves the control vane of the first contact into the control head - moves the control vane of the second contact out of the control head	First control circuit opens Second control circuit closes	..I21..
	moves the control vane of the first and second contact into the control head	Control circuits are opened	..I22..

Up to three contacts (up to four contacts in the aluminium case) can be delivered upon request. The devices are delivered with lateral connecting box as standard. Other connectors upon request.

7. Installation

Care must be taken to ensure that the bulb is not damaged during installation. Do not attempt to bend bulb. The sensing bulb should be totally immersed in the medium which is being measured. If a thermowell is being used, the heat transfer delay can be improved by filling the thermowell with heat transfer substance (i.e. graphite). When fitting bulb into a thermowell it is essential the bulb is not forced against the bottom of the thermowell when tightening the nut. This can lead to increase in pressure within the bulb and cause incorrect readings. The bulb should be inserted into the thermowell until it bottoms and then withdrawn approximately 5 mm before tightening compression nut to hand tight plus quarter turn.

Check capillary is correct length by laying along proposed route. Never attempt to stretch capillary as this will lead to fracture of the system.

The capillary should be securely supported and clipped to wall or other solid surface and must be free from buckling and twists and have a minimum bending radius of 60mm. Particular care should be taken at the points where the capillary enters the case and the bulb. Excess capillary should be coiled and arranged in free swinging loops between the last fixing point and the bulb.

Do not tighten instrument into the system by grasping the case, as any distortion created will lead to calibration errors.

Instrument heads should be mounted in the vertical position unless otherwise agreed with the manufacturer.

8. Maintenance and Storage

The function of the gauge does not require any special maintenance procedures but frequent checks must be made to ensure that the instrument is still working correctly and accurately. Any shift in temperature readings greater than twice the tolerance of the instrument must be investigated and the immediate replacement of the gauge if it is faulty.

Instruments should be stored in dry, clean conditions and care should be taken to ensure the ambient temperature does not exceed or fall below the measuring range of the instruments.

They must be protected against any impact damage.

9. Technical Information

Casing:	Stainless steel 1.4301 with bayonet lock aluminium (100 or 160 mm) with steel ring cover, stainless steel or brass chromium plated profile
Window:	casing: black steel, noryl black instrument glass 4 mm with aluminium case: plexiglass option: safety glass
Protection:	IP 65 IP 54 with black steel
Dial:	aluminium, white with black inscription
Pointer:	aluminium, black
Pointer element:	brass, option for 100 or 160 mm
casing:	stainless steel
Measuring range:	-40 to +40 – 0 to 600°C
Overload protection:	full scale value, option 1.3 x full scale
Accuracy class:	Ø 63 and Ø 80 category 1.6 Ø 100, Ø 160 and Ø 250 category 1
Nominal sizes:	Ø 63, 80, 100, 160 and 250 mm
Probe:	stainless steel 1.4301 with 100 or 160 mm casing stainless steel 1.4571
Probe diameter:	standard: 12 mm option: 8, 9 or 10 mm
Probe length:	to customer specification
Thread:	stainless steel 1.4301
Capillary tube (for model TNF):	stainless steel 1.4571 steel with PVC jacket stainless steel 1.4571 with flexible reinforced protective hose made of 1.4301 red copper (not for 100 and 160 mm Ø)
Transmitter (optional):	
Measuring range:	See temperature range
Current output:	4 – 20 mA, 2-wire
Current output limit:	max. 33 mA
Max. error F.S.:	< 0.5%
Power supply:	13...25 V _{DC}
Loop Resistance:	$R_L = (V_{\text{supply}} - 13V) / 20\text{mA}$
Operating temperature:	-20...+70 °C
Storage temperature:	-20...+110 °C
Connection type:	IP65 Protected against reversed polarity
Wiring:	please see section 6.

10. Order Codes

For model: TNS

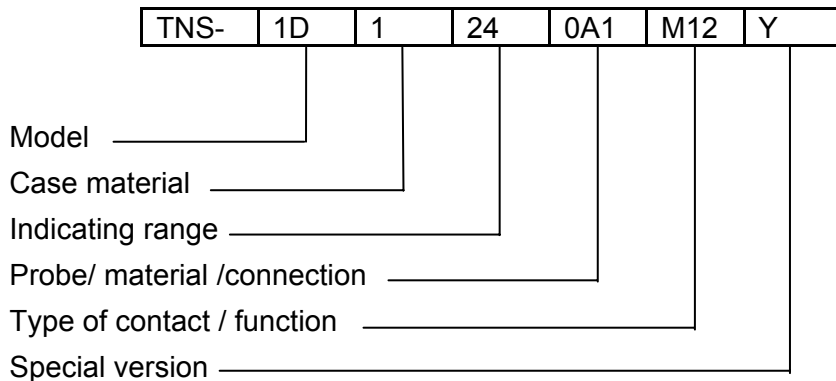

For model: TNF

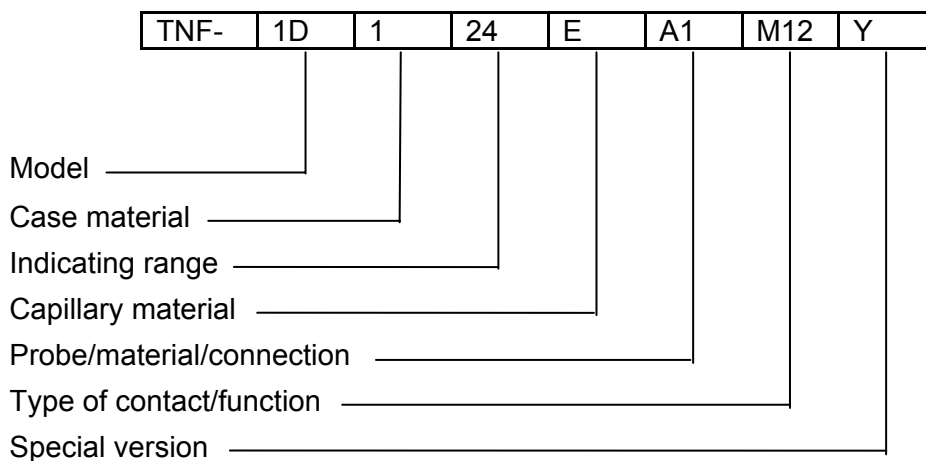

Please specify bulb and length of capillary tube (mm) in writing.

Design / case diameter for model: TNF

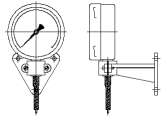
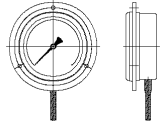
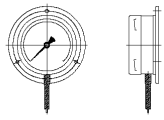
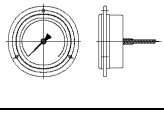
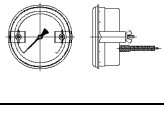
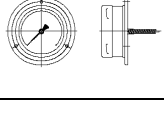
Case diameter					
Design	63	80	100	160	250
	TNF-0D	TNF-0E	TNF-0F	TNF-0G	TNF-0I
	TNF-1D	TNF-1E	TNF-1F	TNF-1G	TNF-1I
	TNF-2D	TNF-2E	TNF-2F	TNF-2G	TNF-2I
	TNF-5D	TNF-5E	TNF-5F	TNF-5G*	TNF-5I
	TNF-8D	TNF-8E	TNF-8F	TNF-8G	TNF-8I
	TNF-6D	TNF-6E	TNF-6F**	TNF-6G**	-

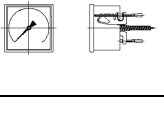
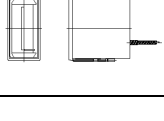
Profile casing	96 x 96 mm		72 x 144 mm
	TNF-Q91.. steel, black finish		TNF-R71.. noryl black

* with 160 mm high-grade steel case eccentric probe exit

** 100 and 160 mm casing in aluminium only

TNS/TNF

Design / case diameter

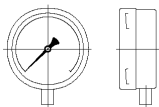
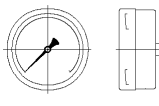
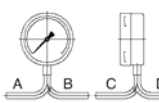
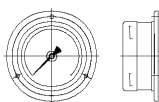
Design	Case diameter				
	63	80	100	160	250
	TNS-0D	TNS-0E	TNS-0F	TNS-0G	TNS-0I
	TNS-1D	TNS-1E	TNS-1F	TNS-1G	TNS-1I
	TNS-AD TNS-BD TNS-CD TNS-DD	TNS-AE TNS-BE TNS-CE TNS-DE	TNS-AF TNS-BF TNS-CF TNS-DF	TNS-AG TNS-BG TNS-CG TNS-DG	TNS-AI TNS-BI TNS-CI TNS-DI
	TNS-8D	TNS-8E	TNS-8F*	TNS-8G*	TNS-8I

* with 100/160 mm st. steel case off-centre probe mounting

Case material

..2.. = stainless steel

..3.. = aluminium ring cover steel, black (for 100/160 mm casing only)

..A.. = aluminium ring cover stainless steel (for 100/160 mm casing only)

Scale ranges

°C	°C	°C
..24.. = -20 ... +40	..08.. = 0 ... +80	..30.. = 0 ... +300
..26.. = -20 ... +60	..10.. = 0 ... +100	..40.. = 0 ... +400
..35.. = -30 ... +50	..12.. = 0 ... +120	..50.. = 0 ... +500
..44.. = -40 ... +40	..16.. = 0 ... +160	..60.. = 0 ... +600
..46.. = -40 ... +60	..20.. = 0 ... +200	
..06.. = 0 ... +60	..25.. = 0 ... +250	

Special measuring ranges: upon request min. $\Delta T = 60^\circ\text{C}$

Capillary tube (only for model: TNF)

- ..E..= stainless steel 1.4571 (standard) (1.4541 with 63, 80, 250 mm case diameters)
- ..P.. = steel with PVC sheathing (only NG 100 / 160)
- ..F.. = stainless steel with flexible stainless steel reinforced hose (1.4301)

Please specify length of capillary tube (mm) when ordering.

**Standard probe / material / connection (probe diameter: 12 mm)
for model: TNF**

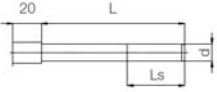
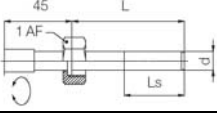
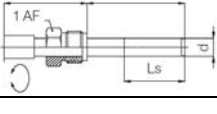
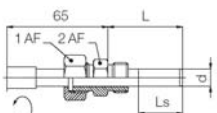
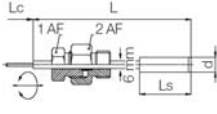
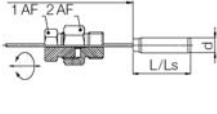
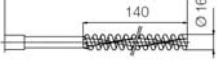
	Description	Material	Thread	Order code
	Smooth probe	Stainless steel	Without	..A0..
	Union nut	Stainless steel	G 1/2 G 3/4 G 1	..B1.. ..B2.. ..B3..
	Rotatable nipple for DIN sleeve	Stainless steel	G 1/2 G 3/4 G 1	..41.. ..42.. ..43..
	Union nut and shoulder nipple	Stainless steel	G 1/2 G 3/4 G 1 1/2 NPT 3/4 NPT 1 NPT	..11.. ..12.. ..13.. ..1A.. ..1B.. ..1C..
	Sliding screwing on extension tube/probe	Stainless steel	G 1/2 G 3/4 G 1 1/2 NPT 3/4 NPT 1 NPT	..91.. ..92.. ..93.. ..9A.. ..9B.. ..9C..
	Sliding screwing on capillary tube	Stainless steel	G 1/2 G 3/4 G 1 1/2 NPT 3/4 NPT 1 NPT	..81.. ..82.. ..83.. ..8A.. ..8B.. ..8C..
	Helix probe for gases	Stainless steel	Smooth probe	..H0..

**Standard probe / material / connection (probe diameter: 12 mm)
for model: TNS**

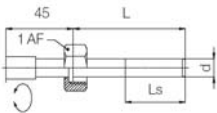
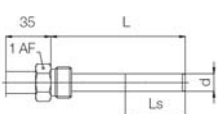
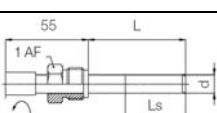
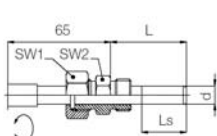
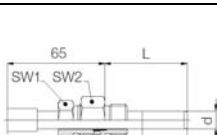
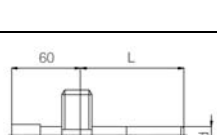
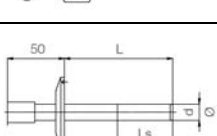
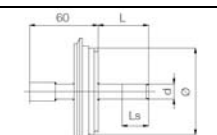
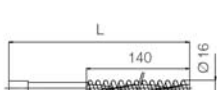
	Description	Material	Thread	Order code
	Smooth probe	Stainless steel	without	..0A0..
	Union nut	Stainless steel	G 1/2 G 3/4 G 1	..0B1.. ..0B2.. ..0B3..
	Simple nipple, rigid	Stainless steel	G 1/2 G 3/4 G 1 1/2 NPT 3/4 NPT 1 NPT	..0C1.. ..0C2.. ..0C3.. ..0CA.. ..0CB.. ..0CC..
	Rotatable nipple for DIN sleeve	Stainless steel	G 1/2 G 3/4 G 1	..041.. ..042.. ..043..
	Union nut and shoulder nipple	Stainless steel	G 1/2 G 3/4 G 1 1/2 NPT 3/4 NPT 1 NPT	..011.. ..012.. ..013.. ..01A.. ..01B.. ..01C..
	Sliding screw on probe	Stainless steel	G 1/2 G 3/4 G 1 1/2 NPT 3/4 NPT 1 NPT	..0S1.. ..0S2.. ..0S3.. ..0SA.. ..0SB.. ..0SC..
	DIN 11851 with polished probe, for the milk and food industry	Stainless steel	1" NW 25 1 1/2" NW 40 2" NW 50 3" NW 75 ANSI auf Anfrage	..0M3.. ..0M5.. ..0M6.. ..0M7..
	TRI-CLAMP ISO 2852 with polished probe	Stainless steel	1" NW 25 1 1/2" NW 40 2" NW 50 ANSI auf Anfrage	..0T3.. ..0T5.. ..0T6..
	Tuchenhagen® with polished probe	Stainless steel	NW 10-15: Ø 31 mm NW 25-32: Ø 50 mm NW 40-50: Ø 68 mm	..0V3.. ..0V5.. ..0V6..
	Helix probe for gases	Stainless steel		..0H0..

Bulb length

Please specify when ordering. Minimum length 50 mm from the sealing collar of the thread.

Special version (Please specify in writing when ordering)

Probe diameter 9 or 10 mm

Test certificate (5 measuring points)

Overtemperature protection (1.3 x)

Safety glass

Dual scale (°C/°F)

Measuring mechanism made of stainless steel (with 100 and 160 mm casing only)

Max. pointer

Red gliding mark pointer

Casing filled with glycerine or oil

Knife edge pointer with fine graduation

Plug according to DIN 43650 with junction box (for unfilled casings only)

Tuchel-plug