

Instruction Manual
for
Ultrasonic Level Meter

Model: NUS-7...



Order from: **C A Briggs Company**
622 Mary Street; Suite 101; Warminster, PA 18974
Phone: 267-673-8117 - Fax: 267-673-8118
Sales@cabriggs.com - www.cabriggs.com

1. Contents

| | |
|--|----|
| 1. Contents..... | 2 |
| 2. Note | 3 |
| 3. Instrument Inspection..... | 3 |
| 4. Regulation Use..... | 3 |
| 5. Operating Principle..... | 4 |
| 6. Mechanical connection..... | 4 |
| 6.1 Block distance..... | 4 |
| 6.2 Installation (Liquid Level Measurement) | 5 |
| 6.3 Installation (Open Channel Flow Measurement)..... | 6 |
| 7. Electrical Connection | 7 |
| 8. Parameters – Description and Programming | 8 |
| 8.1 Measurement configuration | 8 |
| 8.2 Current Output..... | 13 |
| 8.3 Relay Output..... | 14 |
| 8.4 Digital communication..... | 15 |
| 8.4.1 Measurement optimisation..... | 15 |
| 8.5 32-Point linearisation | 24 |
| 8.6 Informational parameters (read out parameters) | 25 |
| 8.7 Additional parameters of the flow metering..... | 26 |
| 9. Error Codes..... | 27 |
| 10. Parameter Table | 28 |
| 11. Sound Velocities in Different Gases..... | 29 |
| 12. Technical Data | 30 |
| 13. Order Codes | 31 |
| 14. Dimensions [mm] | 31 |
| 15. EU Declaration of Conformance..... | 32 |

Manufactured and marketed by:

Kobold Messring GmbH
Nordring 22-24
D-65719 Hofheim
Tel.: 06192-2990
Fax: 06192-23398
Internet: <http://www.kobold.com>
e-mail: info.de@kobold.com

2. Note

Please read these operating instructions before unpacking and putting the unit into operation. Follow the instructions precisely as described herein.

The devices are only to be used, maintained and serviced by persons familiar with these operating instructions and in accordance with local regulations applying to Health & Safety and prevention of accidents.

When used in machines, the NUS should be used only when the machines fulfil the EC-machine guidelines.

3. Instrument Inspection

Instruments are inspected before shipping and sent out in perfect condition. Should damage to a device be visible, we recommend a thorough inspection of the delivery packaging. In case of damage, please inform your parcel service / forwarding agent immediately, since they are responsible for damages during transit.

Scope of delivery:

The standard delivery includes:

- Ultrasonic level meter model: NUS-7
- Instruction Manual

4. Regulation Use

NUS-7 is a rugged, high performance ultrasonic level measurement transmitter, having transducer and processing electronics incorporated in one single housing.

Level measurement technology based on the non-contacting ultrasonic principle is especially suited for applications where, for any reason, no physical contact can be established to the surface of the material to be measured.

Such reasons may include corrosive attack by the process medium against the measuring device material (acids), possible contamination (sewage) or particles of the process medium adhering to the measuring device (adhesive materials).

5. Operating Principle

The sensor emits an ultrasonic pulse train and receives the echoes reflected. The intelligent electronic device processes the received signal by selecting the echo reflected by the surface and calculates from the time of flight the distance between the sensor and the surface. A Norm signal output is available for remote transfer whereas a relay contact is available for monitoring purpose.

A narrow beam angle ensures a reliable measurement in narrow silos with uneven side walls as well as in process tanks with various protruding objects. Furthermore, as a result of the narrow beam angle - the emitted ultrasonic signals have an outstanding focusing - deep penetration through gases, vapour and foam is ensured.

6. Mechanical connection

6.1 Block distance

Due to signal characteristics of the sensor, there is an area directly below the sensor, where no pulses can be received (Dead Zone).

The so called Block distance (minimum measuring distance) is very important for error free functioning of the level meter. It determines the minimal distance between the sensor and maximum level. This distance can be extended by programming in order to avoid disturbing effects of possible disturbing echoes coming from fixed objects (Close-end Blocking).

- Mount the sensor high enough that even with maximum filling of the container, the block distance is not violated. Violation of the block distance may lead to device-malfunction.

| Model | Block distance |
|----------|----------------|
| NUS-7006 | 0.25 m |

6.2 Installation (Liquid Level Measurement)

- Never mount two ultrasonic level-measuring devices in one container, because the two devices can interfere with each other's functioning.

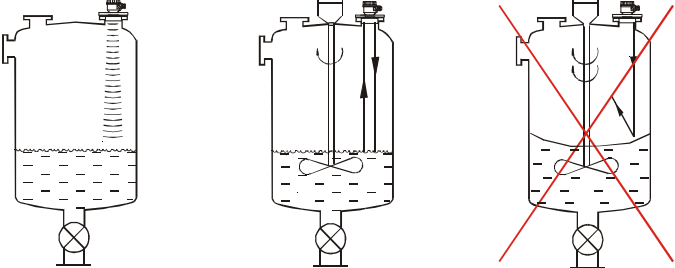
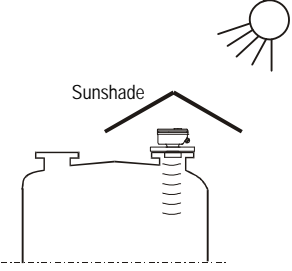
| | |
|---|---|
| <p>POSITION</p> <p>The optimal position of the NUS-4 is on the radius $r = (0.3 \dots 0.5) R$ of the (cylindrical) tank / silo. (Take also sonic cone on page 39 into consideration.)</p> |  |
| <p>SENSOR ALIGNMENT</p> <p>The sensor face has to be parallel to the surface of the liquid within $\pm 2-3^\circ$.</p> | <p>TEMPERATURE</p> <p>Make sure that the transmitter will be protected against overheating by direct sunshine.</p>  |
| <p>OBSTACLES</p> <p>Make sure that no inflow path or objects (e.g. cooling pipes, ladders, bracing members, thermometers, etc.) or no tank wall of the ragged surface protrude into the sensing cone of the ultrasonic beam. One fix object in the tank / silo that disturb the measurement can be blocked out by the optional programming unit.</p> | <p>FOAM</p> <p>Foaming of the liquid surface may render ultrasonic level metering impossible. If possible, a location should be found, where foaming is the least (device should be located as far as possible from liquid inflow) or a stilling pipe or well should be used.</p> <p>WIND</p> <p>Intensive air (gas) movements in the vicinity of the ultrasonic cone is to be avoided. A strong draft of wind may "blow away" the ultrasound. Devices with lower measuring frequency (40, 20 kHz) are recommended.</p> |
| | <p>FUMES / VAPOURS</p> <p>For closed tanks containing chemicals or other liquids, which creates fume/gases above the liquid surface especially for outdoor tanks exposed to the sun, a strong reduction of the nominal measuring range of the ultrasonic device is to be considered during device selection. Devices with lower measuring frequency (40, 20 kHz) are recommended in these cases units.</p> |

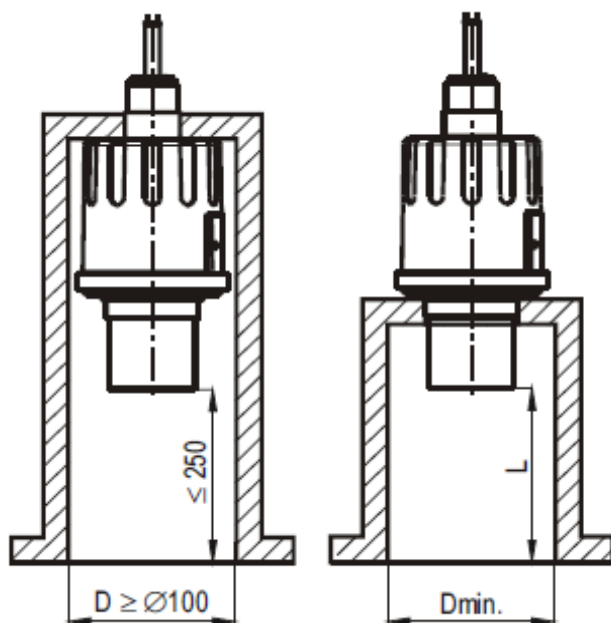

| L | D _{min} |
|-----|------------------|
| 150 | Ø 60 |
| 200 | Ø 65 |
| 250 | Ø 75 |
| 450 | - |

6.3 Installation (Open Channel Flow Measurement)

- For ultimate accuracy, install the sensor as close as possible above the expected maximum water level (see minimum measuring range).
- Install the device in a place defined by the characteristics of the metering channel along the longitudinal axis of the flume or weir.
- In some cases foam may develop on the surface. Make sure that the surface, opposite to the sensor remain free of foam for proper sound reflection.
- From the point of view of measurement accuracy the length of the channel sections preceding and following the measuring flume and their method of joining to the measuring channel section are of critical importance.
- Despite of the most careful installation, the accuracy of flow metering will be lower than that of specified for the distance measurement. It will be determined by the features of the flume or weir applied.

7. Electrical Connection

Make sure the terminals in the box are not under power (Use shielded cable 6 x 0.5 mm² suggested in the technical data or stronger).

After powering the necessary programming can be performed.

Wire colours:

Green – relay C1 output

Yellow – relay CC output

Grey – relay C2 output

White – I, one of the points of current loop, power supply and HART (polarity independent)

Brown – I, other point of current loop, power supply and HART (polarity independent)

Black – GND, functional earthing and shielding point

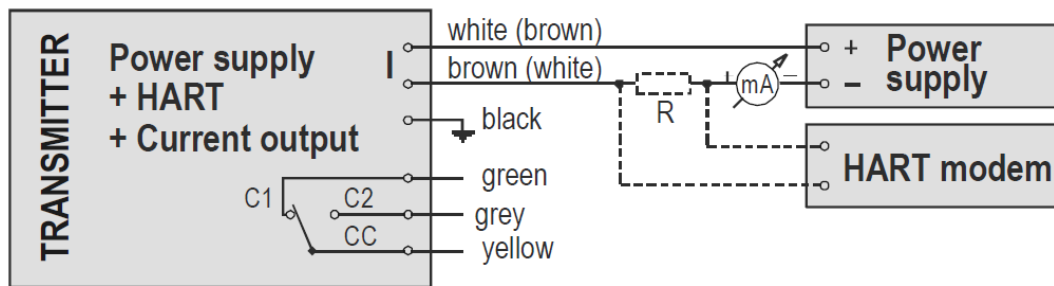

Extension of the integrated cable:

Should extension be needed the use of connection box is suggested.

The shielding of the two cables should be connected and grounded at the signal processing device.

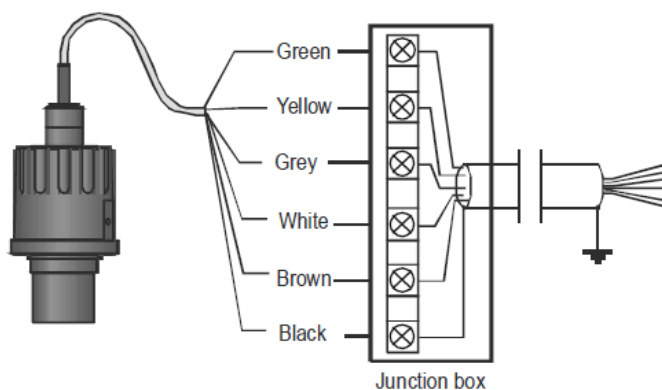

8. Parameters – Description and Programming

The HART interface of the NUS-7 provides for access to the whole parameter set and possibility of their programming. The parameter set can be reached by the use of the software run on the PC connected through HART modem to the loop.

8.1 Measurement configuration

P00: c b a Engineering Units

FACTORY DEFAULT: 000

*Programming of this parameter will result in loading the factory default with the corresponding engineering units.
Therefore all parameters should be set again!*

| a | Operation |
|----------|--------------------------|
| 0 | Liquid level measurement |

| b | Engineering units (according to "c") | |
|----------|--|-----------|
| | Metric | US |
| 0 | m | ft |
| 1 | cm | inch |

| c | Calculation system |
|----------|---------------------------|
| 0 | metric |
| 1 | US |

P01: 1 a Measurement Mode

FACTORY DEFAULT: 11

Parameter value „a” will determine the basic measurement value that will be transmitted. Subsequently values for the relays are also relating to these quantities.

| a | Measurement mode | Transmitted value | Display symbol |
|---|------------------|-------------------|----------------|
| 0 | Distance | Distance | DIST |
| 1 | Level | Level | LEV |
| 2 | Level % | | LEV% |
| 3 | Volume | Volume | VOL |
| 4 | Volume % | | VOL% |
| 5 | Flow | Flow | FLOW |

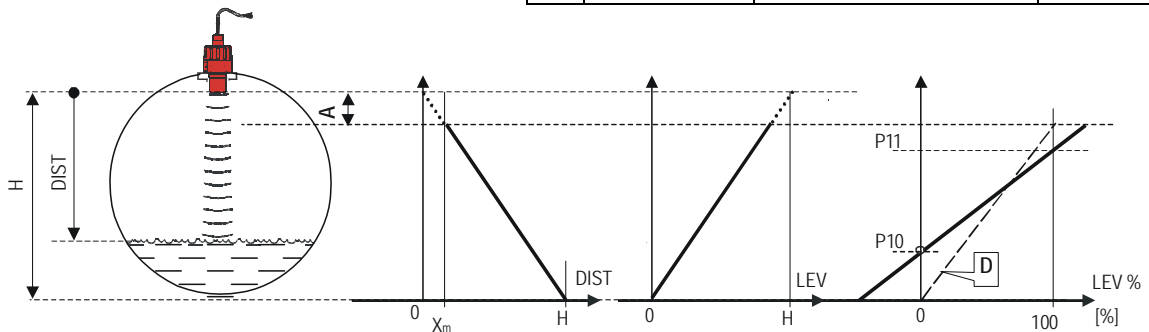

| Transmitted value | DIST | LEV=H-DIST | LEV%= $LEV \cdot \frac{P11-P10}{H-X_m} + P10$ |
|-------------------|---|--|--|
| Parameters to set | P00 P01(a) = 0 P05 ≥ X _m | P00 P01(a) = 1 P04 = H P05 ≥ X _m | P00 P01(a) = 2 P04 = H P05 ≥ X _m P10 = X _{0%} P11 = X _{100%} |

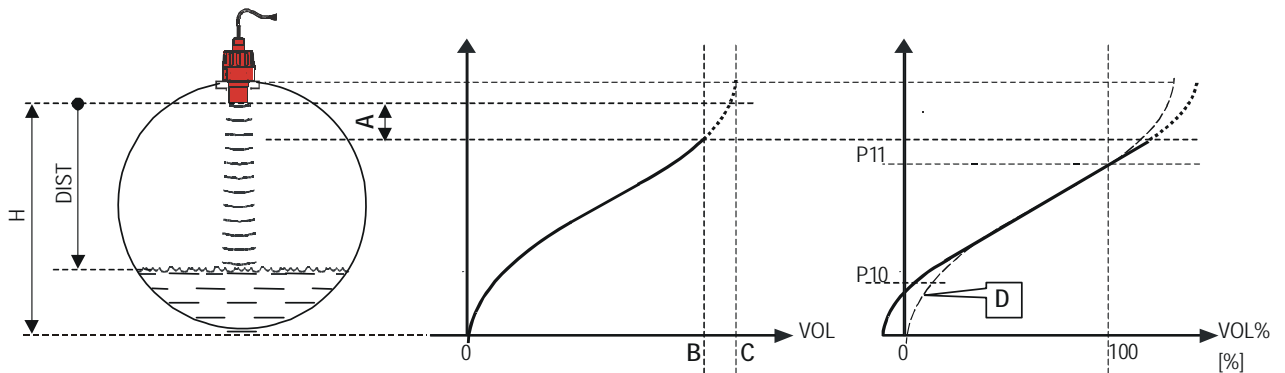

NUS-7

| Transmitted value | VOL f _{P40...P45} (H-DIST) | VOL%= $VOL \times \frac{P11 - P10}{H - X_m} + P10$ |
|-------------------|---|---|
| Parameters to set | P00 P01(a) = 3 P02(b) P04 = H P05 ≥ X _m P40...P45 | P00 P01(a) = 4 P02(b) P04 = H P05 ≥ X _m P10 = X _{0%} P11 = X _{100%} P40...P45 |

A: Shortest measurable distance

B: Volume (content) pertaining to the greatest measurable level

C: Whole value of the vessel

D: diagram valid for the default value of P10 P11

P02:- c b a Calculation units

FACTORY DEFAULT: 000

| a | Temperature |
|---|-------------|
| 0 | °C |
| 1 | °F |

This table is interpreted according to **P00(c)**, **P01(a)** and **P02(c)** and is irrelevant in case of percentage measurement [**P01(a)= 2 or 4**]

| b | Volume | | Weight (set also P32) | | Volume flow | |
|---|----------------|-----------------|-----------------------|------------|----------------------|-----------------------|
| | Metric | US | Metric | US | Metric | US |
| 0 | m ³ | ft ³ | - | lb (pound) | m ³ /time | ft ³ /time |
| 1 | litre | gallon | tons | tonnes | litre/time | gallon/ time |

| c | Time |
|---|------|
| 0 | s |
| 1 | min |
| 2 | hour |
| 3 | day |

Attention!

NUS-7 is a level transmitter. Although it can be used for measuring weight, due to factors involved in doing so, accuracy may essentially be influenced.

P04:-Maximum Distance to be Measured (H) FACTORY DEFAULT: X_M as per chart

This is the only parameter that has to be programmed for each application other than distance (however to avoid disturbing effect of possible multiple echoes it is suggested to do this in distance measurement applications too).

The maximum distance to be measured is the greatest distance between the surface of the transducer and the farthest level to be measured. The factory programmed, greatest distances (DEFAULT values) which **can be measured** by the units are listed in the table below. For the actual application the maximum distance **to be measured** i.e. the distance between the sensor and the bottom of the tank should be entered in P04.

| NUS-7 Level transmitter for liquids | Maximum measuring distance X_M [m/feet] |
|--|---|
| | Transducer material PP / PVDF |
| NUS-7 | 6/20 |

Since the **level** is determined by calculating the difference between the **value set in P04** and **distance (DIST) is measured** by the unit, it is essential that the correct value of (H) is set in **P04**. To obtain the best accuracy it is suggested that this distance is measured in the empty tank.

P05: Minimum measuring distance (Dead zone - Close-end blocking)

FACTORY DEFAULT: X_m as per chart

The range, beginning with the sensor's surface, within which (due to the physical restraint of the ultrasound measurement system) measurement can not be made, is called the dead zone. The NUS-7 will not accept any echo within the blocking distance set here.

Close-end blocking may be represented as the extension of the dead zone within which a possible echo will not be taken into consideration making possible to exclude disturbing objects near to the sensor.

Automatic Close-end blocking =Dead Band control (P05 = X_m)

Device with factory default will automatically *set the smallest possible dead band* depending on the conditions of the operation. This will be under optimal conditions a bit smaller in unfavourable circumstances greater than value given in the chart.

Manual Close-end-blocking with limitation \geq dead zone (P05 > X_m)

By entering a value, higher than the factory default the close-end blocking will be either the value programmed in P05 or the actual dead zone distance (influenced by the actual conditions of the application) whichever is greater.

| NUS-7 for liquids | Minimum measuring distance X_m [m/feet] |
|----------------------|---|
| | Sensor material PP / PVDF |
| NUS-7 | 0.25/0.82 |

P06: Far-end blocking

FACTORY DEFAULT: 0

Far-end blocking is the range below the level set in parameter **P06**. The far-end blocking can be used to avoid disturbing effect of stirrer or heaters at the bottom of the tanks. Detecting echoes in this range the unit provides special signals.

A.) Measuring level or content

Level sinking below

- the value of P06 current output is according to the value of the far-end blocking and further
- below SUB 0 (7/8 of P06) the ERROR CODE 10 will be transmitted via HART

- *Level rising over value of far-end blocking:*

The calculation of level and volume will be based on the programmed tank dimensions, therefore the measured or calculated process values will not be influenced in any way, by the far end blocking value.

B.) Open channel flow metering

Far-end blocking will be used for those small levels below which the accurate volume flow calculation is no longer possible.

- *Level in the flume/weir sinking below the blocked out range:*
- Output current value will be according to the value of $Q = 0$
- 0 value transmitted via HART for display of „No Flow” or 0
- *Level in the flume/weir rising over the blocked out range:*
The calculation of volume flow will be based on the programmed flume/weir data; therefore the measurement values will not be influenced in any way, by the far end blocking value.

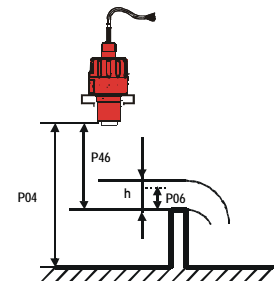
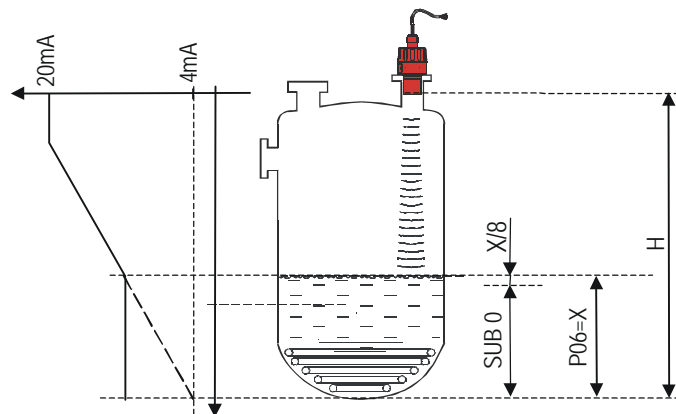

8.2 Current Output

P08: Fixed current output

FACTORY DEFAULT: 0

By this step the output current can be set for a fix value selected from between 3.8 mA and 20.5 mA. This function is not operational as per the factory default: 0.
Attention: fixing output current will make settings in P10, P11, P12 and P19 irrelevant.

P10: Value (of distance, level, volume or flow) assigned to 4 mA current output

FACTORY DEFAULT: 0

P11: Value (of distance, level, volume or flow) assigned to 20 mA current output

FACTORY DEFAULT: $X_M - X_m$

Values are interpreted according to **P01(a)**. Assignment can be made so that the proportion between the change of the (measured or calculated) process value and the change of the current output be either direct or inverse. E.g. level 1 m assigned to 4mA and level 10 m assigned to 20 mA represents direct proportion and level 1 m assigned to 20 mA and level 10 m assigned to 4 mA represents the inverse proportion. Please note that in case of programming for (LEV or VOL) % measurement the min and max value has to be entered in the relevant engineering units of LEV (m, ft) or VOL (m^3 , ft^3).

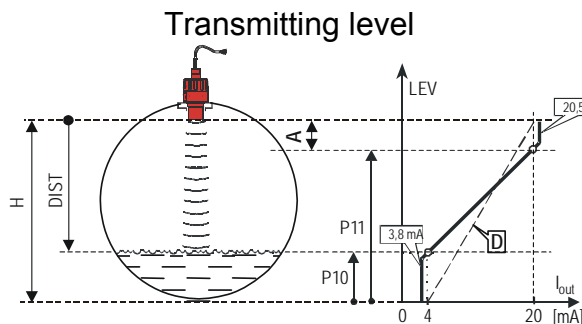

A: Smallest measurable dist.
D: diagram valid for default values of P10 and P11

P12: a Error indication by the current output

FACTORY DEFAULT: 0

In case of error the NUS-7 will provide one of the current outputs below for the time the error prevails. (For errors see Chapter 10).

| a | Error indication by output current |
|---|------------------------------------|
| 0 | HOLD (hold last value) |
| 1 | 3.8 mA |
| 2 | 22 mA |

8.3 Relay Output

P13: a Relay function

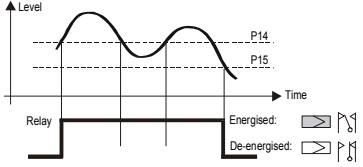
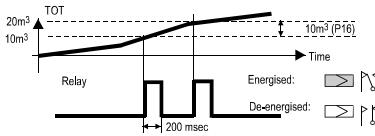
| a | Relay function | Also set: |
|---|---|--|
| 0 | <p>DIFFERENTIAL LEVEL CONTROL (Hysteresis control)</p> <p>Relay is energised if the measured or calculated value exceeds the value set in P14</p> <p>Relay is de-energised if the measured or calculated value descends under the value set in P15</p> |  <p>P14, P15</p> <p>There is a need to set (in level min 20mm) hysteresis between P14 and P15</p> <p>P14 > P15 – normal operation</p> <p>P14 < P15 – inverted operation</p> |
| 1 | Relay is energised in case of Echo Loss | - |
| 2 | Relay is de-energised in case of Echo Loss | - |
| 3 | <p>COUNTER</p> <p>Used for open channel flow metering.</p> <p>A 140 msec pulse is generated every 1, 10, 100, 1.000 or 10.000 m³ according to P16.</p> |  <p>P16= 0: 1m³</p> <p>P16= 1: 10 m³</p> <p>P16= 2: 100 m³</p> <p>P16= 3: 1.000 m³</p> <p>P16= 4: 10.000 m³</p> |

In de-energised state of the device the „C1” circuit is closed.

FACTORY DEFAULT: 2

P14: Relay parameter – Operating value

FACTORY DEFAULT: 0

P15: Relay parameter – Releasing value

FACTORY DEFAULT: 0

P16: Relay parameter – Pulse rate

FACTORY DEFAULT: 0

FACTORY DEFAULTS: P14=0, P15=0, P16=0

8.4 Digital communication

P19: Short (HART) address of the unit FACTORY DEFAULT: 2

These addresses with 0 ... 15 are, in accordance with the HART standard, for distinguishing units in the same loop.

- Address: 0 current output of 4 ... 20 ma operational
- Address: 1 ... 15 current output is fixed to 4 mA.

8.4.1 Measurement optimisation

P20: a Damping FACTORY DEFAULT: 5

This parameter can be used to reduce unwanted fluctuation of the display and output.

| a | Damping (s) | No or moderate fume / waves | Heavy or dense fume or turbulent waves |
|---|-------------|-----------------------------|--|
| 0 | no filter | For testing only | |
| 1 | 3 | applicable | not recommended |
| 2 | 6 | recommended | applicable |
| 3 | 10 | recommended | recommended |
| 4 | 30 | recommended | recommended |
| 5 | 60 | recommended | recommended |

P22: a Dome top tank compensation FACTORY DEFAULT: 0

This parameter can be used to reduce disturbing effect of possible multiple echoes

| a | Compensation | Remark |
|---|--------------|--|
| 0 | OFF | In case the NUS-7 is not mounted in the centre of the top and the top is flat. |
| 1 | ON | In case the NUS-7 is mounted in the centre of a tank with dome-shaped top |

P24: a Target tracking speed FACTORY DEFAULT: 0

In this parameter evaluation can be speed up at the expense of the accuracy.

| a | Tracking speed | Remark |
|---|----------------|--|
| 0 | Standard | For most applications |
| 1 | Fast | For fast changing level |
| 2 | Special | Only for special applications (measuring range is reduced to 50% of the nominal value) The measuring window is inactive and the NUS-7 will respond practically instantly to any target. |

P25: a Selection of Echo within the measuring window

FACTORY DEFAULT: 0

A so-called measuring window is formed around the echo signal. The position of this measuring window determines the flight time for calculation of the distance to the target. (the picture below can be seen on the test oscilloscope)

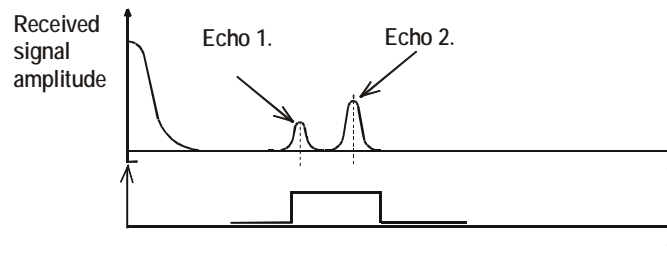

Some applications involve multiple (target + disturbing) echoes even within the measuring window. Basic echo selection will be done by the Quest + software automatically. This parameter influences the echo selection only within the measuring window.

| a | Echo in the window to be selected | Remark |
|---|-----------------------------------|---|
| 0 | With the highest amplitude | Most frequently used |
| 1 | First one | For liquids applications with multiple echoes within the Measuring Window |

P26: Level elevation rate (filling speed) (m/h or ft/h)

FACTORY DEFAULT: 2000

P27: Level descent rate (emptying speed)) (m/h or ft/h)

FACTORY DEFAULT: 2000

These parameters provide additional protection against echo loss in applications involving very heavy fuming. Correct setting increases reliability of the measurement during filling and emptying. The parameters must not be smaller than the fastest possible filling/emptying rate of the actual technology.

Attention! Level changing rate is rather different near to the conical or spherical bottom of such a vessel.

P28: a Echo loss indication

FACTORY DEFAULT: 0

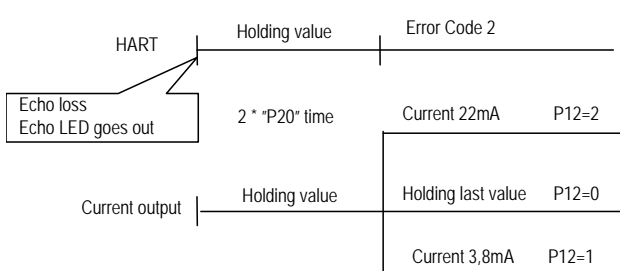
| a | Echo loss indication | Remark |
|---|-----------------------|---|
| 0 | Delayed indication | <p>During short echo-loss (for the period of twice the time set in P20) analogue output will hold last value. After this period the current value according to the setting in P12 and via HART ERROR CODE 2 will be transmitted.</p>  |
| 1 | No indication | For the time of echo-loss, analogue output will hold last value. |
| 2 | Filling simulation | Loosing echo during the filling process, transmitted value will increase according to the filling speed set in P26 |
| 3 | Immediate indication | Loosing echo the current value (according to the setting in P12) and the ERROR CODE 2 (via HART) will immediately be transmitted. |
| 4 | Empty tank indication | Echo-loss may occur in completely empty tanks with a spherical bottom due to deflection of the ultrasonic beam, or in case of silos with an open outlet. In such cases it may be useful to indicate empty tank instead of echo loss. |

P29: Blocking out of disturbing object

FACTORY DEFAULT: 0

One fixed object in the tank, disturbing the measurement, can be blocked out. By the use of the Echo Map (**P70**) the precise distance of disturbing object can be read out. This value should be entered in this parameter.

P31: Sound velocity at 20°C (m/s or ft/s depending on P00(c))

FACTORY DEFAULT:: 343,8 (m/s), 1128 (ft/s)

This parameter should be used if the sound velocity in the gases above the measured surface differs largely from that of in the air. This is recommended for applications where the gas is more or less homogeneous. If it is not, the accuracy of the measurement can be improved using 32-point linearisation (**P48, P49**).

For sound velocities in various gases see section "Sound Velocities".

P32: Specific gravity

FACTORY DEFAULT: 0

Entering a value (other than "0") of specific gravity in this parameter, the weight will be displayed instead of VOL.

Engineering unit should be [kg/dm³] or [lb/ft³] depending on P00 (c)

Volume (content) measurement

P40: Tank shape

FACTORY DEFAULT: 00

| b a | Tank shape | Also to be set |
|--------|---|-------------------------|
| b 0 | Standing cylindrical tank shape (value of "b" as below) | P40 (b), P41 |
| 0 1 | Standing cylindrical tank with conical bottom | P41, P43, P44 |
| 0 2 | Standing rectangular tank (with chute) | P41, P42, P43, P44, P45 |
| b 3 | Lying cylindrical tank shape (value of "b" as below) | P40 (b), P41, P42 |
| 0 4 | Spherical tank | P41 |

Attention!
The value „a” determining the shape of the tank should be set first.

P41-45: Tank dimensions

FACTORY DEFAULT: 0

Standing cylindrical tank with hemispherical bottom a=0

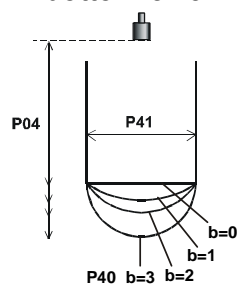

Standing cylindrical tank with conical bottom a=1 b=0

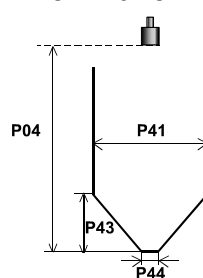

Standing rectangular tank with or without chute a=2 b=1

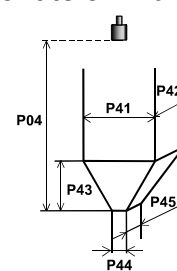

Plain bottom
P43, P44
and P45 =
0

Lying cylindrical tank a = 3

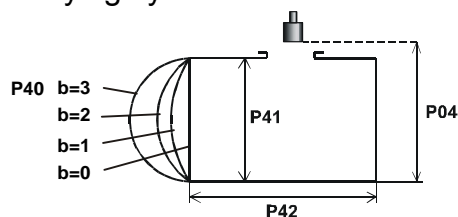

Spherical tank a = 4, b = 0

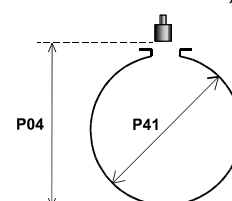

Open channel flow measurement

P40: b a Devices, formula, data

FACTORY DEFAULT: 00

| ba | Devices, formula, data | | | | | Also to be set |
|-----------|--|-------------------------------------|------------|------------|----------|----------------------|
| | Type | Formula | Qmin [l/s] | Qmax [l/s] | “P” [cm] | |
| 00 | GPA-1P1 | $Q [l/s] = 60.87 \cdot h^{1.552}$ | 0.26 | 5.38 | 30 | P46 |
| 01 | GPA-1P2 | $Q [l/s] = 119.7 \cdot h^{1.553}$ | 0.52 | 13.3 | 34 | P46 |
| 02 | GPA-1P3 | $Q [l/s] = 178.4 \cdot h^{1.555}$ | 0.78 | 49 | 39 | P46 |
| 03 | GPA-1P4 | $Q [l/s] = 353.9 \cdot h^{1.558}$ | 1.52 | 164 | 53 | P46 |
| 04 | GPA-1P5 | $Q [l/s] = 521.4 \cdot h^{1.558}$ | 2.25 | 360 | 75 | P46 |
| 05 | GPA-1P6 | $Q [l/s] = 674.6 \cdot h^{1.556}$ | 2.91 | 570 | 120 | P46 |
| 06 | GPA-1P7 | $Q [l/s] = 1014.9 \cdot h^{1.556}$ | 4.4 | 890 | 130 | P46 |
| 07 | GPA-1P8 | $Q [l/s] = 1368 \cdot h^{1.5638}$ | 5.8 | 1208 | 135 | P46 |
| 08 | GPA-1P9 | $Q [l/s] = 2080.5 \cdot h^{1.5689}$ | 8.7 | 1850 | 150 | P46 |
| 09 | General PARSHALL flume | | | | | P46, P42 |
| 10 | PALMER-BOWLUS (D/2) | | | | | P46, P41 |
| 11 | PALMER-BOWLUS (D/3) | | | | | P46, P41 |
| 12 | PALMER-BOWLUS (Rectangular) | | | | | P46, P41, P42 |
| 13 | Khafagi Venturi | | | | | P46, P42 |
| 14 | Bottom-step weir | | | | | P46, P42 |
| 15 | Suppressed rectangular or BAZIN weir | | | | | P46, P41, P42 |
| 16 | Trapezoidal weir | | | | | P46, P41, P42 |
| 17 | Special trapezoidal (4:1) weir | | | | | P46, P42 |
| 18 | V-notch weir | | | | | P46, P42 |
| 19 | THOMSON (90°-notch) weir | | | | | P46 |
| 20 | Circular weir | | | | | P46, P41 |
| 21 | General flow formula: $Q [l/s] = 1000 \cdot P41 \cdot h^{P42}$, h [m] | | | | | P46, P41, P42 |

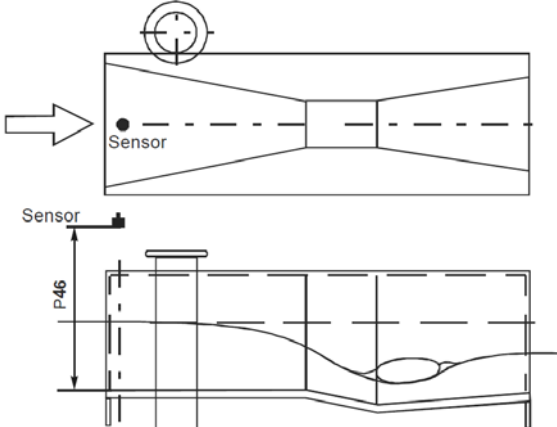
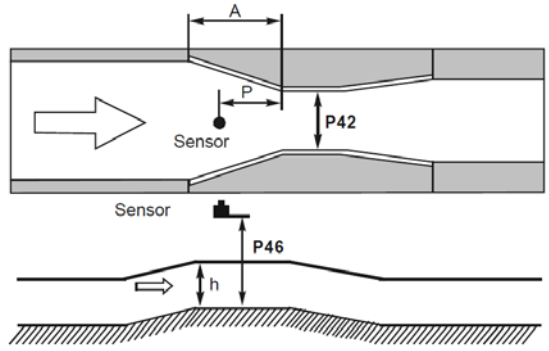
| <p>P40=00</p> | <p>KOBOLD Parshall flumes</p> |  | | | | | | | | | | | | | | |
|----------------------|---|--|---|------|-------|------|-------|------|-------|------|-------|------|-------|-------|-------|---|
| <p>P40=09</p> | <p>General Parshall flume $0.305 < P42(\text{width}) < 2.44$ $Q[l/s] = 372 P42 \cdot (h/0,305)^{1,569} P42^{0,026}$ $2.5 < P42$ $Q[l/s] = K \cdot P42 \cdot h^{1,6}$ $P = 2/3 \cdot A$</p> <table border="1" data-bbox="587 952 837 1124"> <thead> <tr> <th>P42 [m]</th> <th>K</th> </tr> </thead> <tbody> <tr> <td>3.05</td> <td>2.450</td> </tr> <tr> <td>4.57</td> <td>2.400</td> </tr> <tr> <td>6.10</td> <td>2.370</td> </tr> <tr> <td>7.62</td> <td>2.350</td> </tr> <tr> <td>9.14</td> <td>2.340</td> </tr> <tr> <td>15.24</td> <td>2.320</td> </tr> </tbody> </table> | P42 [m] | K | 3.05 | 2.450 | 4.57 | 2.400 | 6.10 | 2.370 | 7.62 | 2.350 | 9.14 | 2.340 | 15.24 | 2.320 |  |
| P42 [m] | K | | | | | | | | | | | | | | | |
| 3.05 | 2.450 | | | | | | | | | | | | | | | |
| 4.57 | 2.400 | | | | | | | | | | | | | | | |
| 6.10 | 2.370 | | | | | | | | | | | | | | | |
| 7.62 | 2.350 | | | | | | | | | | | | | | | |
| 9.14 | 2.340 | | | | | | | | | | | | | | | |
| 15.24 | 2.320 | | | | | | | | | | | | | | | |

| | | |
|-----------------------|--|--|
| <p>P40= 10</p> | <p>Palmer-Bowlus (D/2) flume $Q[m^3/s]= f(h1/P41)*P41^{2.5}$, where $h1[m]= h+(P41/10)$ P41 [m]</p> | |
| <p>P40= 11</p> | <p>Palmer-Bowlus (D/3) flume $Q[m^3/s]= f(h1/P41)*P41^{2.5}$, where $h1[m]= h+(P41/10)$ P41 [m]</p> | |
| <p>P40= 12</p> | <p>Palmer-Bowlus (rectangular) flume $Q[m^3/s]= C*P42*h^{1.5}$, where $C= f(P41/P42)$ P41 [m], P42 [m]</p> | |

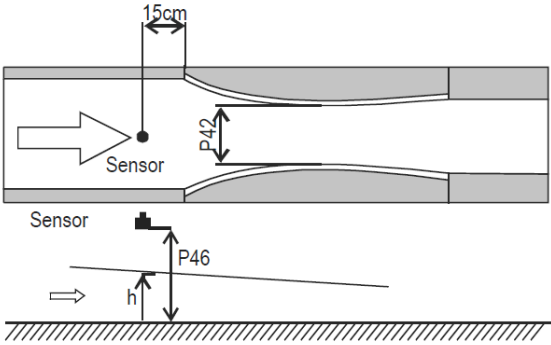
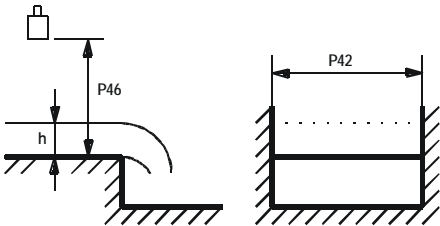
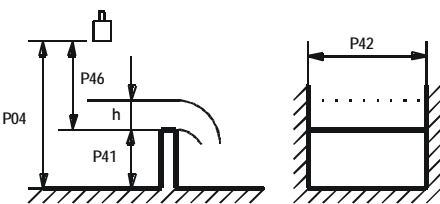
| | | |
|-----------------------|--|--|
| <p>P40= 13</p> | <p>Khafagi Venturi flume</p> <p>$Q [m^3/s] = 1.744 \cdot P42 \cdot h^{1.5} + 0.091 \cdot h^{2.5}$</p> <p>P42 [m]</p> <p>h [m]</p> |  |
| <p>P40= 14</p> | <p>Bottom step weir</p> <p>$0.0005 < Q [m^3/s] < 1$</p> <p>$0.3 < P42 [m] < 15$</p> <p>$0.1 < h [m] < 10$</p> <p>$Q [m^3/s] = 5.073 \cdot P42 \cdot h^{1.5}$</p> <p>Accuracy: $\pm 10\%$</p> | <p>P40=14</p>  |
| <p>P40= 15</p> | <p>Suppressed rectangular or BAZIN weir</p> <p>$0.001 < Q [m^3/s] < 5$</p> <p>$0.15 < P41 [m] < 0.8$</p> <p>$0.15 < P42 [m] < 3$</p> <p>$0.015 < h [m] < 0.8$</p> <p>$Q [m^3/s] = 1.77738(1 + 0.1378h/P41) \cdot P42 \cdot (h + 0.0012)^{1.5}$</p> <p>Accuracy: $\pm 1\%$</p> | <p>P40=15</p>  |

| | | |
|-----------------------|--|---------------|
| <p>P40= 16</p> | <p>Trapezoidal weir $0.0032 < Q \text{ [m}^3\text{/s]} < 82$ $20 < P41[^\circ] < 100$ $0.5 < P42 \text{ [m]} < 15$ $0.1 < h \text{ [m]} < 2$ $Q \text{ [m}^3\text{/s]} = 1.772 \cdot P42 \cdot h^{1.5} + 1.320 \cdot \text{tg}(P41/2) \cdot h^{2.47}$ Accuracy: $\pm 5\%$</p> | <p>P40=16</p> |
| <p>P40= 17</p> | <p>Special trapezoidal (4:1) weir $0.0018 < Q \text{ [m}^3\text{/s]} < 50$ $0.3 < P42 \text{ [m]} < 10$ $0.1 < h \text{ [m]} < 2$ $Q \text{ [m}^3\text{/s]} = 1.866 \cdot P42 \cdot h^{1.5}$ Accuracy: $\pm 3\%$</p> | <p>P40=17</p> |
| <p>P40= 18</p> | <p>V-notch weir $0.0002 < Q \text{ [m}^3\text{/s]} < 1$ $20 < P42[^\circ] < 100$ $0.05 < h \text{ [m]} < 1$ $Q \text{ [m}^3\text{/s]} = 1.320 \cdot \text{tg}(P42/2) \cdot h^{2.47}$ Accuracy: $\pm 3\%$</p> | <p>P40=18</p> |

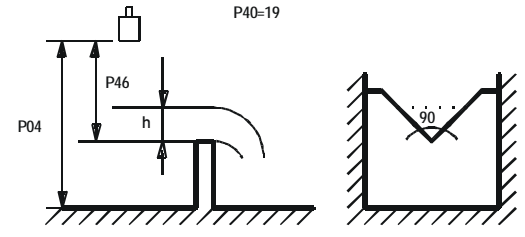
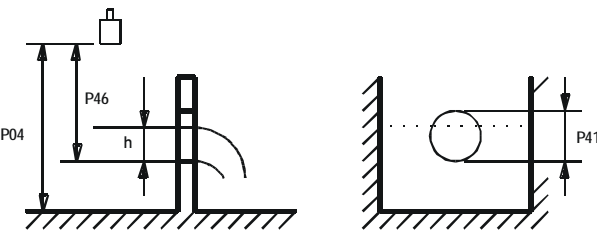
| | | |
|-----------------------|--|--|
| <p>P40= 19</p> | <p>THOMSON (90°-notch) weir $0.0002 < Q \text{ [m}^3\text{/s]} < 1$ $0.05 < h \text{ [m]} < 1$ $Q[\text{m}^3\text{/s}] = 1.320 \cdot h^{2.47}$ Accuracy: $\pm 3\%$</p> |  |
| <p>P40= 20</p> | <p>Circular weir $0.0003 < Q \text{ [m}^3\text{/s]} < 25$ $0.02 < h \text{ [m]} < 2$ $Q[\text{m}^3\text{/s}] = m \cdot b \cdot D^{2.5}$, where $b = f(h/D)$ $m = 0.555 + 0.041 \cdot h/P41 + (P41/(0.11 \cdot h))$ Accuracy: $\pm 5\%$</p> |  |

P46: Distance at Q=0 FACTORY DEFAULT: 0

Distance between sensor surface and the level at which flow starts has to be entered in this parameter.

8.5 32-Point linearisation

P47: a Linearisation FACTORY DEFAULT: 0

Linearisation is the method of assigning requested (calibrated or calculated) level, volume or flow to values measured by the transmitter.

It can be used for instance if the sound velocity is not known (LEVEL \Rightarrow LEVEL) or in the case of tank with other shape than under 6.4 or open channel other than under 6.5 (LEVEL \Rightarrow VOLUME or LEVEL \Rightarrow FLOW).

| a | Linearisation |
|---|-----------------------|
| 0 | OFF (FACTORY DEFAULT) |
| 1 | ON |

Conditions of correct programming of the data pairs

The table must always start with: $L(1) = 0$ and $r(1) =$ value (assigned to 0 level)

The table must be ended either with the 32nd data pair i.e. $j=32$ or if the linearisation table contains less than 32 data-pairs $j<32$, it must be ended with a level value "0" e.g. $L(j<32) = 0$.

The NUS-7 will ignore data after recognising level value "0" with serial number other than "1".

If the above conditions are not met, error codes will be displayed (see chapter: Error Codes).

| i | L (Left column) Level values measured | r (Right column) Value assigned to transmit |
|------|---|---|
| 1 | 0 | r(1) |
| 2 | L(2) | r(2) |
| | L(i) | r(i) |
| nn | L(nn) | r(nn) |
| nn+1 | 0 | |
| 32 | | |

P48: Number of linearisation data pairs

Number of linearisation data pairs entered in the table.

8.6 Informational parameters (read out parameters)

P60: Overall operating hours of the unit (h)

P61: Time elapsed after last switch-on (h)

P62: Operating hours of the relay (h)

P63: Number of switching cycles of the relay

P64: Actual temperature of the transducer (°C/°F)

Broken loop of the thermometer will be indicated by display of the Pt Error message initiated by a signal sent via HART. In this case the transmitter will perform temperature correction corresponding to 20°C.

P65: Maximum temperature of the transducer (°C/°F)

P66: Minimum temperature of the transducer (°C/°F)

P70: Number of Echoes / Echo Map

Amplitude and position of the echoes can also be read out.

P71: Distance of the of Measuring Window

P72: Amplitude of the selected echo [dB] <0

P73: Position of the selected echo (time) :(ms)[ms]

P74: Signal To Noise Ratio

| Ratio | Measurement conditions |
|-------------------|------------------------|
| Over 70 | Excellent |
| Between 70 and 30 | Good |
| Under 30 | Unreliable |

P75: Blocking Distance

The actual close-end blocking distance will be displayed (provided automatic blocking was selected in **P05**).

8.7 Additional parameters of the flow metering

P76: Head of flow (LEV) (Read only parameter)

The Headwater value can be checked here. This is the “h” value in the formula for flow calculation.

P77: TOT1 volume flow totalised (resettable)

P78: TOT2 volume flow totalised (non-resettable)

Supplementary parameter of the logger

P79: Free space of logger in percent

If the value is 0, the registry has overflowed and every new entry will overwrite the oldest one.

Clearing the logger

- 1). Enter parameter **P79**.
- 2). Press \leftarrow + \downarrow keys.
- 3). The display flashes „Lo-Clr” message.
- 4). Pressing ⓔ will clear the logger.

Other parameters

P96: Software code 1 (Read only parameter)

P97: Software code 2 (Read only parameter)

P98: Hardware code (Read only parameter)

P99: dcbA Access lock by secret code

The purpose of this feature is to provide protection against accidental programming or intentional reprogramming of parameters by a person not entitled to do so. The secret code can be any value other than **0000**. Setting a secret code will automatically be activated when the NUS-7 is returned to the Measurement Mode. In order to program locked device the secret code should be entered first in **P99**. Thus for entering a new code or erasing the old one the knowledge of the previous code is necessary.

9. Error Codes

| Error Code | Error description | Causes and solutions |
|----------------|--|---|
| 1 | Memory error | Contact local agent |
| No Echo | Echo loss | See Action 5 and 6 |
| 3 | Hardware error | Contact local agent |
| 4 | Display overflow | Check settings |
| 5 | Sensor error or improper installation/mounting, level in the dead band | Verify sensor for correct operation and check for correct mounting according to the User's Manual |
| 6 | The measurement is at the reliability threshold | Better location should be tried. |
| 7 | No signal received within the measuring range specified in P04 and P05 | Review programming, also look for installation mistake |
| 12 | Linearisation table error: both L(1) and L(2) are zero (no valid data-pairs) | See the Section "Linearisation" |
| 13 | Linearisation table error: there are two same L(i) data in the table | See the Section "Linearisation" |
| 14 | Linearisation table error: the r(i) values are not monotone increasing | See the Section "Linearisation" |
| 15 | Linearisation table error: measured Level is higher than the last Volume or Flow data-pair | See the Section "Linearisation" |
| 16 | The check sum of the program in the EEPROM is wrong | Contact local agent |
| 17 | Parameter consistency failure | Check programming |
| 18 | Hardware failure | Contact local agent |

10. Parameter Table

| Par. | Page | Description | Value | | | | Par. | Page | Description | Value | | | |
|------|------|---|-------|---|---|---|------|------|--|-------|---|---|---|
| | | | d | c | b | a | | | | d | c | b | a |
| P00 | 8 | Application/Engineering Units | | | | | P28 | 17 | Echo loss indication | | | | |
| P01 | 9 | Measurement Mode | | | | | P29 | 17 | Blocking out a disturbing object | | | | |
| P02 | 10 | Calculation units | | | | | P30 | - | - | | | | |
| P03 | - | - | | | | | P31 | 17 | Sound velocity values in different gases | | | | |
| P04 | 10 | Maximum Measuring Distance | | | | | P32 | 18 | Specific gravity | | | | |
| P05 | 11 | Minimum Measuring Distance | | | | | P33 | - | - | | | | |
| P06 | 12 | Far End Blocking | | | | | P34 | - | - | | | | |
| P07 | - | - | | | | | P35 | - | - | | | | |
| P08 | 13 | Fixed current output | | | | | P36 | - | - | | | | |
| P09 | - | - | | | | | P37 | - | - | | | | |
| P10 | 13 | Transmitted value assigned to „4 mA“ | | | | | P38 | - | - | | | | |
| P11 | 13 | Transmitted value assigned to „20 mA“ | | | | | P39 | - | - | | | | |
| P12 | 14 | “Error“ indication by the current output | | | | | P40 | 18 | Selection of tank shape/ open channel | | | | |
| P13 | 14 | Relay function | | | | | P41 | 18 | Dimensions of tank / Open Channel | | | | |
| P14 | 14 | Relay parameter – Operating value | | | | | P42 | 18 | Dimensions of tank / Open Channel | | | | |
| P15 | 14 | Relay parameter – Releasing value | | | | | P43 | 18 | Dimensions of tank / Open Channel | | | | |
| P16 | 14 | Relay parameter – Pulse rate | | | | | P44 | 18 | Dimensions of tank / Open Channel | | | | |
| P17 | - | - | | | | | P45 | 18 | Dimensions of tank / Open Channel | | | | |
| P18 | - | - | | | | | P46 | 24 | Level pertaining to flow Q= 0 | | | | |
| P19 | 15 | Short address of the unit | | | | | P47 | 25 | Linearisation | | | | |
| P20 | 15 | Damping | | | | | P48 | 25 | Linearisation table | | | | |
| P21 | - | - | | | | | P49 | - | - | | | | |
| P22 | 15 | Dome top tank compensation | | | | | P50 | - | - | | | | |
| P23 | - | - | | | | | P51 | - | - | | | | |
| P24 | 15 | Target tracking speed | | | | | P52 | - | - | | | | |
| P25 | 16 | Selection of Echo in the measuring window | | | | | P53 | - | - | | | | |
| P26 | 16 | Level elevation rate | | | | | P54 | - | - | | | | |
| P27 | 16 | Level descent rate | | | | | P55 | - | - | | | | |
| P56 | - | - | | | | | P78 | 26 | TOT2 volume flow totalised | | | | |
| P57 | - | - | | | | | P79 | 26 | Free space of the logger in percent | | | | |
| P58 | - | - | | | | | P80 | - | - | | | | |
| P59 | - | - | | | | | P81 | - | - | | | | |
| P60 | 25 | Overall operating hours of the unit | | | | | P82 | - | - | | | | |
| P61 | 25 | Time elapsed after last switch-on | | | | | P83 | - | - | | | | |
| P62 | 25 | Operating hours of the relay | | | | | P84 | - | - | | | | |
| P63 | 25 | Number of switching cycles of the relay | | | | | P85 | - | - | | | | |
| P64 | 25 | Actual temperature of the transducer | | | | | P86 | - | - | | | | |
| P65 | 25 | Maximum temperature of the transducer | | | | | P87 | - | - | | | | |
| P66 | 25 | Minimum temperature of the transducer | | | | | P88 | - | - | | | | |
| P67 | - | - | | | | | P89 | - | - | | | | |
| P68 | - | - | | | | | P90 | - | - | | | | |
| P69 | - | - | | | | | P91 | - | - | | | | |
| P70 | 25 | Echo Map | | | | | P92 | - | - | | | | |
| P71 | 25 | Position of the measuring window | | | | | P93 | - | - | | | | |
| P72 | 25 | Amplitude of the selected echo | | | | | P94 | - | - | | | | |
| P73 | 25 | Position of the selected echo | | | | | P95 | - | - | | | | |
| P74 | 25 | Signal / noise ratio | | | | | P96 | 26 | Software code 1 | | | | |
| P75 | 25 | Blocking distance value | | | | | P97 | 26 | Software code 2 | | | | |
| P76 | 26 | Water head of the flow | | | | | P98 | 26 | Hardware code | | | | |
| P77 | 26 | TOT1 volume flow totalised | | | | | P99 | 26 | Access lock by secret code | | | | |

11. Sound Velocities in Different Gases

The following table contains the sound velocity of various gases measured at.

| Gases | | Sound Velocity (m/s) |
|----------------------|-------------|----------------------|
| Acetaldehyde | C_2H_4O | 252.8 |
| Acetylene | C_2H_2 | 340.8 |
| Ammonia | NH_3 | 429.9 |
| Argon | Ar | 319.1 |
| Benzene | C_6H_6 | 183.4 |
| Carbon dioxide | CO_2 | 268.3 |
| Carbon monoxide | CO | 349.2 |
| Carbon tetrachloride | CCl_4 | 150.2 |
| Chlorine | Cl_2 | 212.7 |
| Dimethyl ether | CH_3OCH_3 | 213.4 |
| Ethane | C_2H_6 | 327.4 |
| Ethanol | C_2H_5OH | 267.3 |

| Gases | | Sound Velocity (m/s) |
|----------------------|----------|----------------------|
| Ethylene | C_2H_4 | 329.4 |
| Helium | He | 994.5 |
| Hydrogen sulphide | H_2S | 321.1 |
| Methane | CH_4 | 445.5 |
| Methanol | CH_3OH | 347 |
| Neon | Ne | 449.6 |
| Nitrogen | N_2 | 349.1 |
| Nitrogen monoxide | NO | 346 |
| Oxygen | O_2 | 328.6 |
| Propane N.A. | C_3H_8 | 246.5 |
| Sulphur hexafluoride | SF_6 | 137.8 |
| | | |

12. Technical Data

| | |
|--------------------------|--|
| Measuring range: | 0.25...6 m / 0.8...20 feet ¹⁾ |
| Total beam angle: | 5° |
| Ambient temperature: | -30...+80 °C (-22 °F...+176 °F) |
| Process pressure abs.: | 0.5...3 bar (7.5...43.5 psig) |
| Process connection: | G2, 2" NPT |
| Materials: | |
| housing: | PP or PVDF |
| transducer: | PP or PVDF |
| cable sealing: | EPDM, |
| cable isolation: | PVC |
| Accuracy ¹⁾ : | ± 0.2% of measured distance + 0.05% of range) |

¹⁾ Under optimal circumstances of reflection and stabilized transducer temperature

| | |
|-----------------------------------|---|
| Resolution (dep. on distance): | <2 m (6.5 feet): 1 mm (0.04 inch); 2...5 m (6.5...16.5 feet); 2 mm (0.075 inch); 5...10 m (16.5...33 feet); 5 mm (0.2 inch) |
| Ingress protection: | IP68 |
| Outputs 2-wire: | standard: 4-20 mA + HART®, max. 600 Ω, relay (SPDT, 30 V/ 1 A DC; 48 V/0.5 A AC) |
| Power supply 2-wire: | 12...36 V _{DC} /44...800 mW |
| Connection cable 2-wire: | LICY type 2x0.5 mm ² (AWG 20) shielded cable, ø 6 mm (0.25 inch); standard length 5 m (16.5 feet) can be ordered max. 30 m (100 feet) |

13. Order Codes

Example: NUS-7 0 06 R9 3 4H 5

| Model | Sensor material | Range | Connection | Power supply | Output | Cable length |
|-------|-------------------------------|---------------|------------------------|---------------------------|--|---|
| NUS-7 | 0 = PP (standard) 9 = PVDF | 06 = 0.25-6 m | R9 = G2 N9 = 2" NPT | 3 = 12-36 V _{DC} | 4H = 4-20 mA + HART® RH = 4-20 mA + relay + HART® | 5 = standard 5 m Y = accord. to customer specifications, max. 30 m |

Order codes HART® modem: HARTCOMM



14. Dimensions [mm]

NUS-7 level transmitter for liquids – 2-wire series

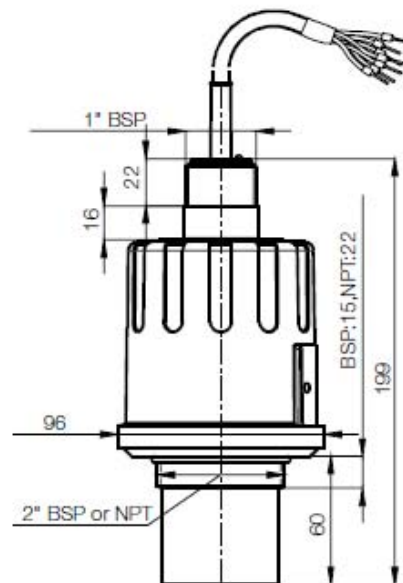
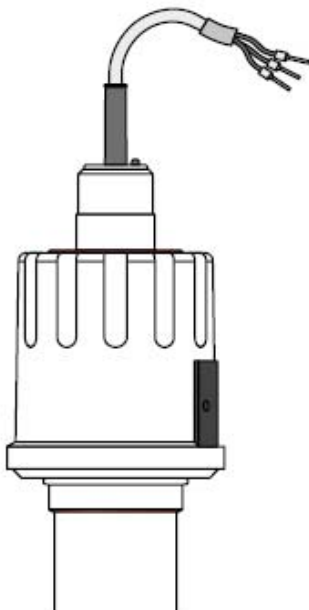

15. EU Declaration of Conformance

We, KOBOLD Messring GmbH, Hofheim-Ts, Germany, declare under our sole responsibility that the product:

Ultrasonic Level Meter Model: NUS

to which this declaration relates is in conformity with the standards noted below:

EN 61010-1:2011 Safety requirements for electrical equipment for measurement, control and laboratory use – Part 1: General requirements

EN 61326-1:2013 Electrical equipment for measurement, control and laboratory use - EMC requirements – Part 1: General requirements

EN 61326-2-3:2013 Electrical equipment for measurement, control and laboratory use - EMC requirements - Part 2-3: Particular requirements - Test configuration, operational conditions and performance criteria for transducers with integrated or remote signal conditioning

Also the following EU guidelines are fulfilled:

2014/30/EU EMC Directive
2011/65/EU RoHS

Furthermore for equipment with supply voltage < 48 V:

2014/35/EU Low Voltage Directive

Hofheim, 11. May 2017

H. Peters
General Manager

M. Wenzel
Proxy Holder