

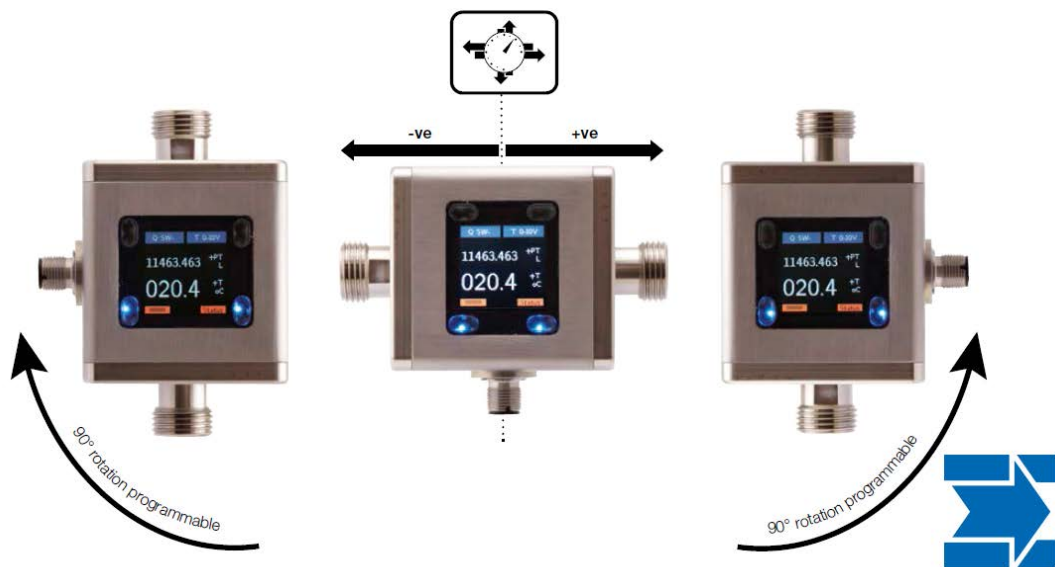

# Operating Instructions for Electromagnetic Flowmeter Model: MIM



We don't accept warranty and liability claims neither upon this publication nor in case of improper treatment of the described products.

The document may contain technical inaccuracies and typographical errors. The content will be revised on a regular basis. These changes will be implemented in later versions. The described products can be improved and changed at any time without prior notice.

© **Copyright**

**All rights reserved.**

## 1. Contents

---

1. Contents.....	2
2. Note .....	4
2.1 Overview of the device functionality.....	4
3. Instrument Inspection.....	5
4. Regulation Use .....	5
5. Environment.....	5
6. Operating principle .....	6
6.1 General.....	6
6.2 Minimum electrical conductivity / Gas bubbles .....	6
6.3 Deposits.....	6
6.4 Measuring electrodes .....	7
7. Mechanical connection.....	7
7.1 Check operating conditions.....	7
7.2 Installation.....	7
8. Electrical Connection .....	9
8.1 General.....	9
8.2 Pin assignment .....	10
8.3 Connection example outputs: .....	14
9. Operation and menu structure .....	15
9.1 General.....	15
9.2 Measuring mode .....	16
9.3 Menu Mode.....	19
10. Device configuration.....	20
10.1 Sequence of device parameterization.....	20
10.2 Language.....	20
10.3 Display .....	21
10.4 Measurement.....	23
10.5 Dosing function .....	30
10.6 Outputs .....	30
10.7 User service.....	41
10.8 Service / Factory service.....	42
10.9 Info.....	42
10.10 Device default settings.....	42
11. Status.....	43
12. Dosing function .....	44
13. IO-Link function .....	47
13.1 Specification .....	48

14. Technical Information.....	49
15. Order Codes .....	52
16. Dimensions .....	54
17. Appendix.....	56
17.1 IO-Link process data structure.....	56
17.2 IO-Link diagnosis information .....	57
17.3 IO-Link system command table .....	58
17.4 IO Link ISDU parameter table.....	59
18. Manufacturer's declaration.....	71
19. EU Declaration of Conformance .....	72

**Manufactured and sold by:** KOBOLD Instruments Inc  
1801 Parkway View Drive  
Pittsburgh PA 15205-1422  
Tel.: 412-788-2830  
Fax: 412-788-4890  
E-Mail: [info@koboldusa.com](mailto:info@koboldusa.com)  
Internet: [www.koboldusa.com](http://www.koboldusa.com)

## 2. Note

---

Please read these operating instructions before unpacking and putting the unit into operation. Follow the instructions precisely as described herein.

The devices are only to be used, maintained and serviced by persons familiar with these operating instructions and in accordance with local regulations applying to Health & Safety and prevention of accidents.

When used in machines, the measuring unit should be used only when the machines fulfil the EC-machine guidelines.

### as per PED 2014/68/EU

In acc. with Article 4 Paragraph (3), "Sound Engineering Practice", of the PED 2014/68/EU no CE mark.

Diagram 8, Pipe, Group 1 dangerous fluids

### 2.1 Overview of the device functionality



Depending on the installed device firmware, the MIM device may have different functionalities. The functional extensions are shown in the following table.

Function extension	Available from firmware version
Dosing function	REV180118
Menu languages Simulation function User function keys Analogue output 2-10 V <sub>DC</sub> Analogue output behavior acc. to NAMUR NE43	REV180514
IO-Link Control input	REV190320
Additional flow units L/s and mL/s	REV191030
Filter function for flow and temperature measurement	REV200608

The installed software version is displayed after starting the device below the manufacturer logo in the form REVxxxxxx for approx. 2 sec.

---

## 3. Instrument Inspection

---

Instruments are inspected before shipping and sent out in perfect condition. Should damage to a device be visible, we recommend a thorough inspection of the delivery packaging. In case of damage, please inform your parcel service / forwarding agent immediately, since they are responsible for damages during transit.

**Scope of delivery:**

The standard delivery includes:

- Electromagnetic Flowmeter      model: MIM
- Operating Instructions

---

## 4. Regulation Use

---

The MIM flowmeter has been specially developed for the measurement, display and transmission of both, flow rates and temperature of conductive liquids. The instrument has a graphic TFT display, rotatable in 90 ° steps and can display flow rate, temperature, daily volume counter (resettable) and total volume counter in the units of measurement selected by the operator. A clear menu guides the user through the parameterization of the device, which largely eliminates the need to look into the operating instructions.

Any use of the magnetic flowmeter, model: MIM, which exceeds the manufacturer's specification, may invalidate its warranty. Therefore, any resulting damage is not the responsibility of the manufacturer. The user assumes all risk for such usage.

---

## 5. Environment

---

The MIM device with stainless steel housing and stainless steel electrodes is weatherproof and conforms to protection class IP67. The meter is designed for harsh indoor or outdoor environments and complies with Directive 2014/30/EU (Electromagnetic Compatibility).

To avoid moisture in the device from condensation, a pressure compensation element is integrated on the front.

This element must not be pierced.

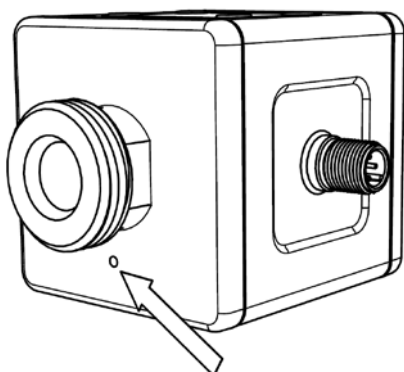

## 6. Operating principle

---

### 6.1 General

The new KOBOLD MIM Flowmeter is designed to measure and monitor small and medium flows of conductive fluids in piping.

The device works on the magnetic-inductive measuring principle. According to Faraday's law of induction, a voltage is induced in a conductor moving in a magnetic field. The electrically conductive measuring medium corresponds to the moving conductor in the process. The voltage induced by the measuring medium is proportional to the flow rate and thus a measure of the volume throughput. Prerequisite is a minimum electrical conductivity of the flowing medium. The induced voltage is fed to a measuring amplifier via two electrodes, which are in conductive contact with the medium. The volume flow is calculated via the defined pipe diameter.

The measurement is independent of the medium and its physical properties such as density, viscosity and temperature. The device can be configured via the display. There are two outputs available, which can each be configured as alarm, frequency, pulse, voltage, and current outputs.

The device also provides a dosing function. The dosing function can be activated in measuring mode via the four buttons. The dosing function controls simple filling tasks and also measures flow rate and partial amount.

### 6.2 Minimum electrical conductivity / Gas bubbles

For the correct function of the instrument, it is necessary that the flow channel is always completely filled with medium. From a minimum electrical conductivity of 20  $\mu\text{S} / \text{cm}$ , the MIM operates within the specified error limits. The conductivity of the medium is constantly monitored by the device electronics. If the electronics detects that the minimum conductivity has fallen below min. value, this is signaled by displaying the error message 'Empty pipe' and the flow rate reading is set to '0'. Air bubbles in the flowing medium or media with varying conductivity in the range of the minimum conductivity can disturb the measuring function and reduce the measuring accuracy of the MIM. Gases contained in the liquid are also measured as a flow volume and lead to measurement errors. If necessary, install appropriate vents in the flow of the unit.

### 6.3 Deposits

Minor deposits on the measuring tube generally do not affect the measuring accuracy unless their conductivity deviates significantly from the liquid. For liquids that have a tendency to deposit, periodically inspect the meter tube and, if necessary, clean it.

## 6.4 Measuring electrodes

The MIM uses electrodes with galvanic tapping. They are in direct contact with the medium. The standard electrodes are made of stainless steel 1.4404.

In very rare cases (e.g. oils or fats in the metered medium), electrically insulating media deposits on the meter electrodes. Such deposits would cause a failure of the meter.

In such cases, the electrodes must be cleaned with a soft brush and a grease solvent.

## 7. Mechanical connection

---

### 7.1 Check operating conditions

- flow rate
- max. operating pressure
- max. operating temperature

In general, MIM is subjected to the same loads as the piping into which it is installed. The MIM should therefore be kept away from extreme loads, such as pressure surges with strong, dynamic pipe movements, vibrations in the proximity of centrifugal pumps, high temperature media, flooding etc.

### 7.2 Installation

- Remove all packing materials and transport retainers and ensure that no such materials remain in the device.
- It can be installed in vertical, horizontal or rising pipes. Flow in direction of the arrow.
- Avoid pressure and tensile load.
- Mechanically secure the inlet and outlet pipe at a distance of 50 mm from the connections.
- Avoid valves or large reduction on the inlet section (this increases the inaccuracy of measurements).
- Check the leak tightness of the connections.



---

**While mounting MIM hold the flowmeter from spanner surface (not from the housing) with the help of spanner.  
Take into account the tightening torque.**

---

# MIM-

Nominal size	Tightening torque
1/2"	22 to 24 Nm
3/4"	28 to 30 Nm
1"	28 to 30 Nm

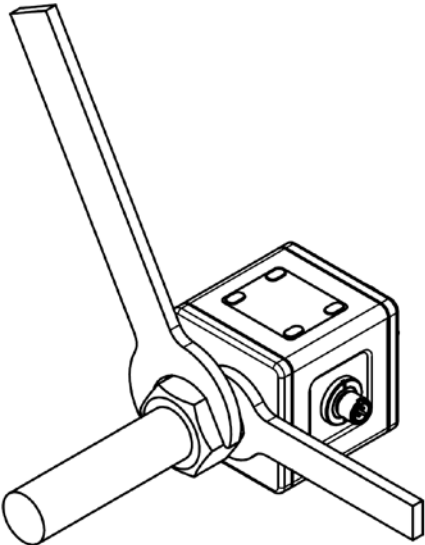

### Inlet and outlet run

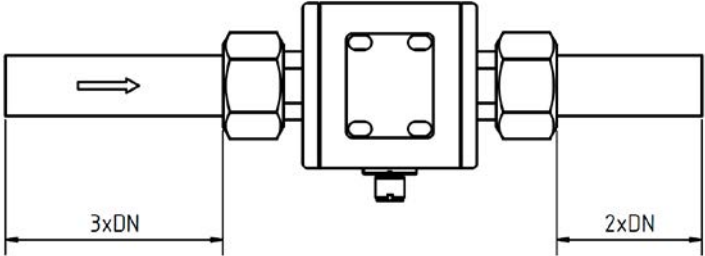

### Installation from top to bottom

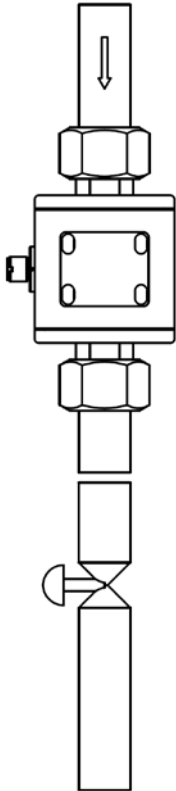

### avoid these installation locations

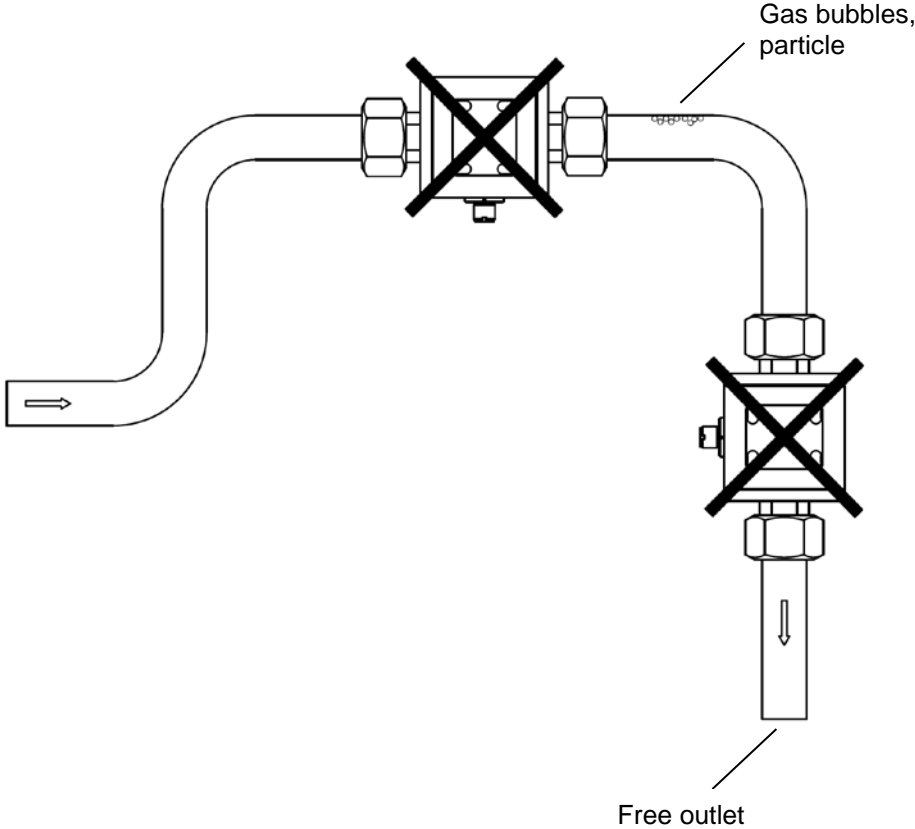



## 8. Electrical Connection

### 8.1 General



**Attention! Make sure that the voltage values of your system correspond with the voltage values of the measuring unit.**

- Make sure that the supply wires are de-energised.
- Connect the supply voltage and the output signal **to the plug PIN's as stated below.**
- We recommend the use of wires with cross sectional area of min. 0.25 mm<sup>2</sup>.



**Attention! The measuring electrodes are galvanically connected with the reference potential of the supply voltage and the signal output.**

#### 8.1.1 Grounding/ Earthing

If the device is installed in a continuously grounded / earthed metallic pipe, no additional grounding / earthing of the housing is generally necessary. When installing in a plastic pipe or any ungrounded pipe, the housing must be grounded at the side threaded hole (M4) to ensure proper functionality of the MIM. **If a class 2 switched-mode power supply (all-insulated, without an external protective earth connection) is used for the power supply, the grounding must be connected to ensure functionality.** A M4 screw (thread length max. 8 mm), a matching washer, a ring cable lug and a toothed lock washer are required for correct installation.

These mechanical parts are not part of the delivery.

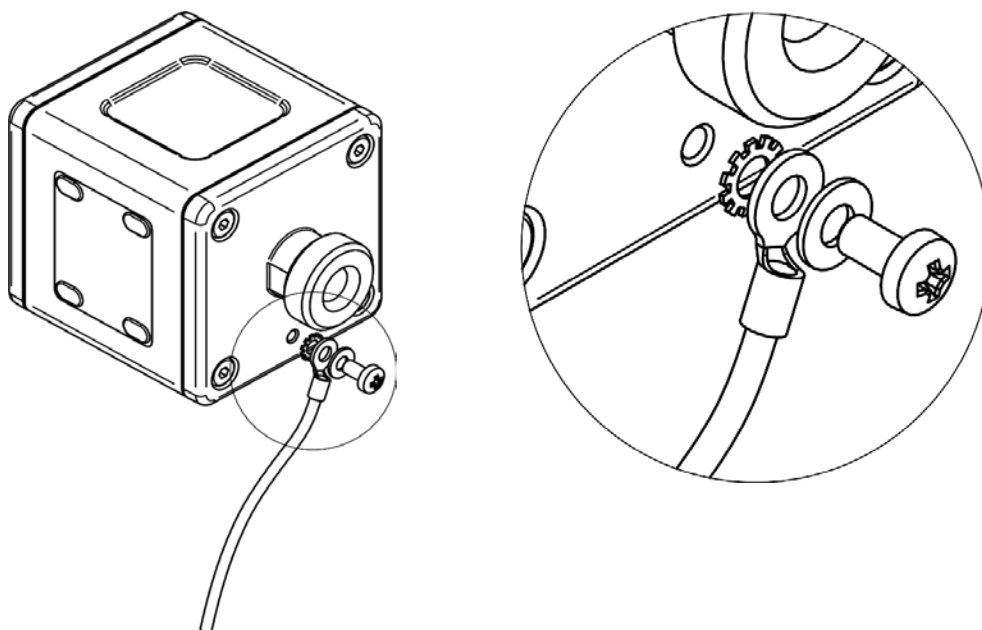

## 8.2 Pin assignment

### 8.2.1 External connection with electrical connector M12x1 4-pin for options C3T0 / Exx0 and Pxx0

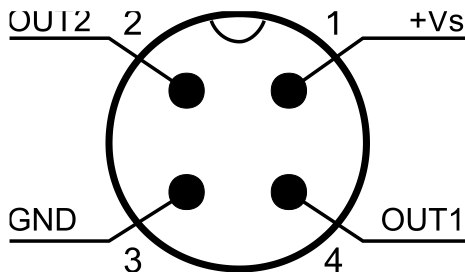

### 8.2.2 Connection Exx0 / Pxx0 sensor

For the remote versions Pxx0 (PVC cable) and Exx0 (ETFE cable), the sensor and transmitter are delivered ex works with the cable connected.

The on-site installation may require dismantling the cable and reconnecting it later.



---

#### Note:

In principle, the cable can be shortened by the user on the transmitter side and connected to the transmitter again after appropriate assembly.

---



---

#### Attention!

A customer extension of the connection cable is not recommended because of the necessary continuous shielding and leads to malfunction of the device. The cable permanently connected to the sensor must not be disassembled.

---

Wiring diagram Transmitter

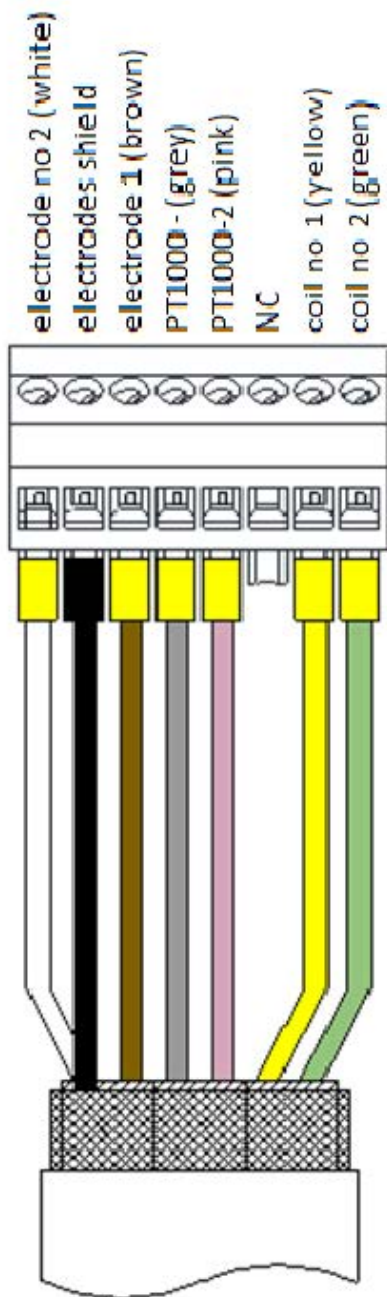

Termination Connection cable  
 (PVC and ETFE cable)

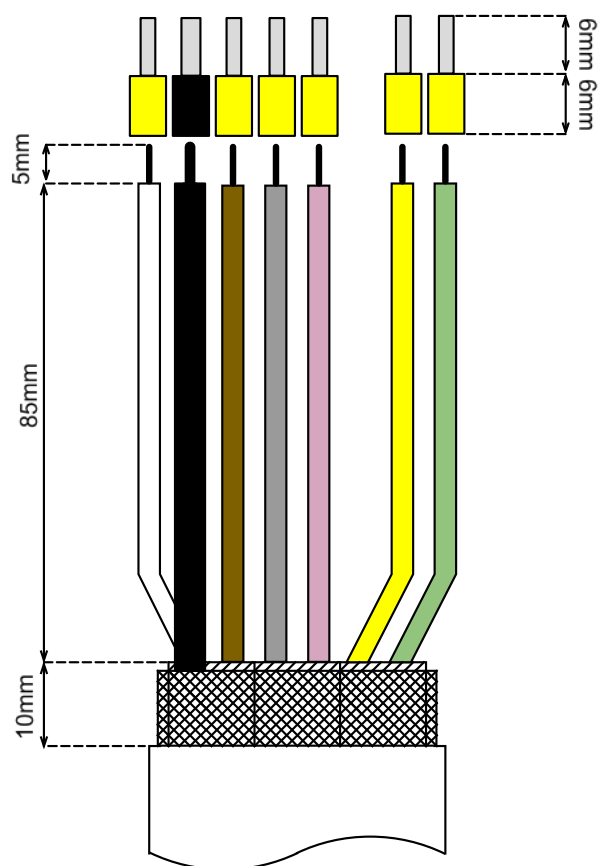

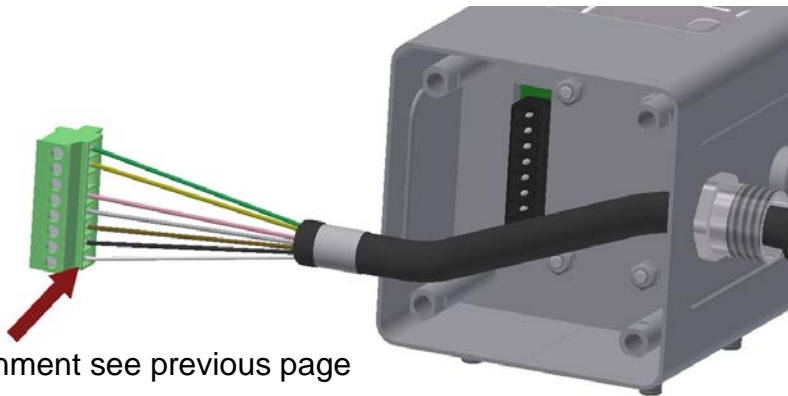

Pin assignment see previous page

Insert pre-assembled cable through the cable gland and connect to the connector strip



Pull back the cable and put the contact spring on the outer shield

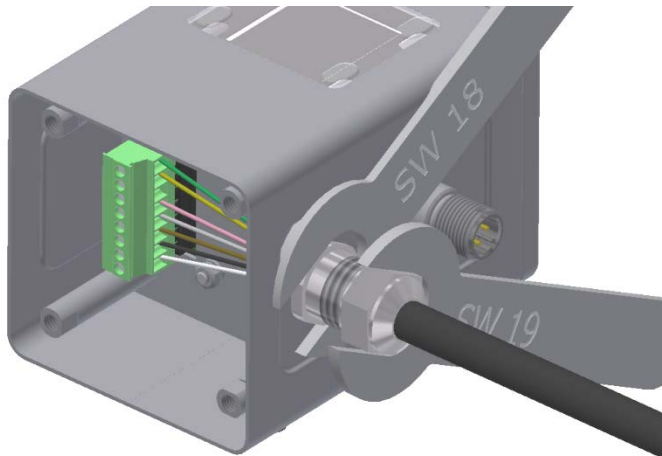

Push the cable into the cable gland, insert the plug connector and tighten the hexagon nut of the cable gland with SK key SW 19 and lock with SW 18

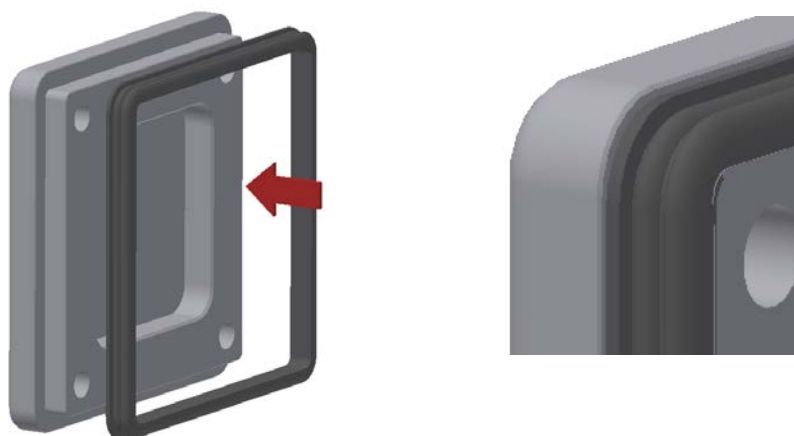

Insert gasket, make sure gasket is seated correctly

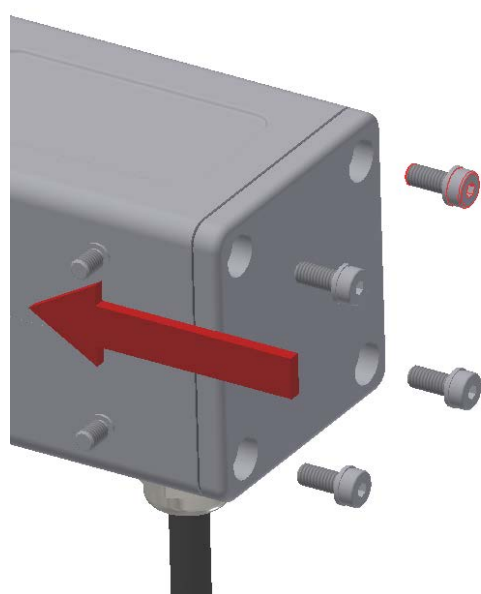

Put the laminated seal disc on the screw and screw the threaded connection in the housing.  
When tightening the screws, reduce the gap between sheet metal housing and the cover to ~ 0.5 mm

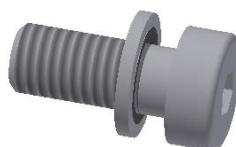

8.3 Connection example outputs:

OUT2: analogue output 4-20 mA  
 OUT1: analogue output 0-10 V

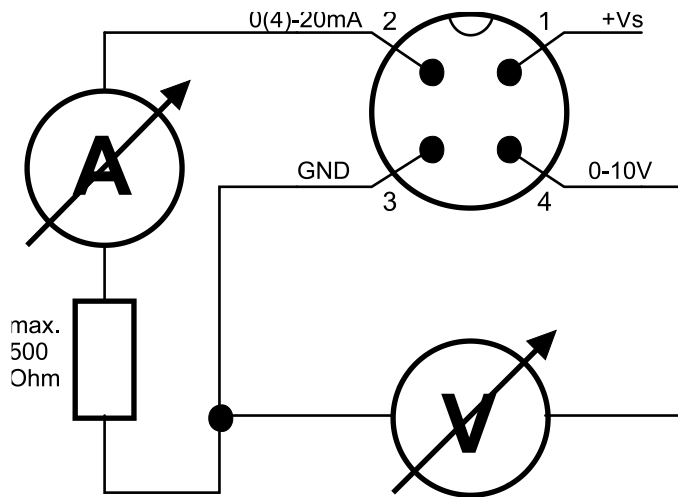

Configurable output functions:

Out 1	Out 2
analogue output 4-20 mA	analogue output 4-20 mA
analogue output 0-20 mA	analogue output 0-20 mA
analogue output 2-10 V	analogue output 2-10 V
analogue output 0-10 V	analogue output 0-10 V
alarm output	alarm output
pulse output	pulse output
frequency output	frequency output
communication mode KofiCom	
communication mode IO Link	
control input	
control input dosing function	dosing output

## 9. Operation and menu structure

### 9.1 General

#### 9.1.1 Operation of the optical buttons

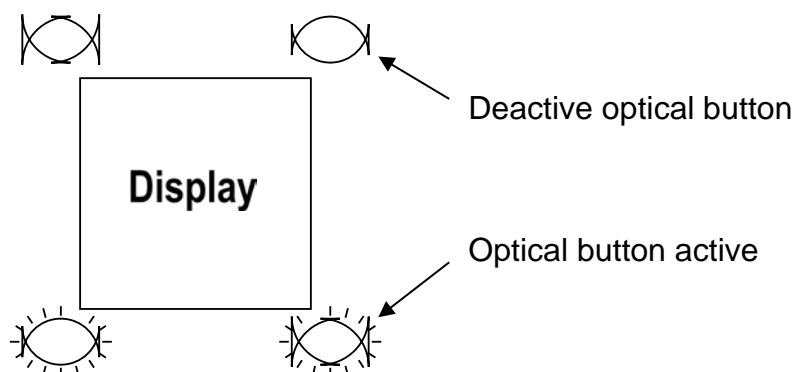

An optical button is located at each corner of the TFT display. The operability of the respective buttons is signaled by blue backlighting; therefore, non-backlit buttons are disabled and cannot be operated. To operate the keys, the finger must be placed on the key-dome and raised again. The orange background of the button symbols is briefly displayed in blue as visual feedback for a detected key press.

To avoid accidental operation in measuring mode, the operator must hold down the menu button for 3-5 seconds to activate the function. If the menu button is held down for more than 3 seconds, the blue backlighting will begin to flash to alert the user to release the button.

The operation of the optical buttons can also be done with gloves or other optically reflective objects. Suitable types of gloves are: cotton and textile gloves, light leather gloves, hygiene gloves made of latex and lightly rubberized work gloves. Black-coated work gloves of all kinds are not suitable. Light dirt on the surface usually does not interfere with the key function.

#### 9.1.2 Function of the control buttons

The function of each control key can be recognized by the respective symbol displayed in the corners of the TFT display.

key symbol	designation	function	
		Measuring mode	menu mode
	menu mode	Activate menu mode hold <b>3-5 sec.</b>	-
	info display	opens the info menu	-
	down	-	Scroll down menu / decrease numeric value when entering numeric value
	up	-	Menu scroll up / Increase the number

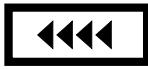
key symbol	designation	function	
		Measuring mode	menu mode
			value for numeric value input
	forward	-	Menu level lower / forward (last menu level: Save value)
	backward	-	Menu function: menu level higher / back (last step: exit menu)

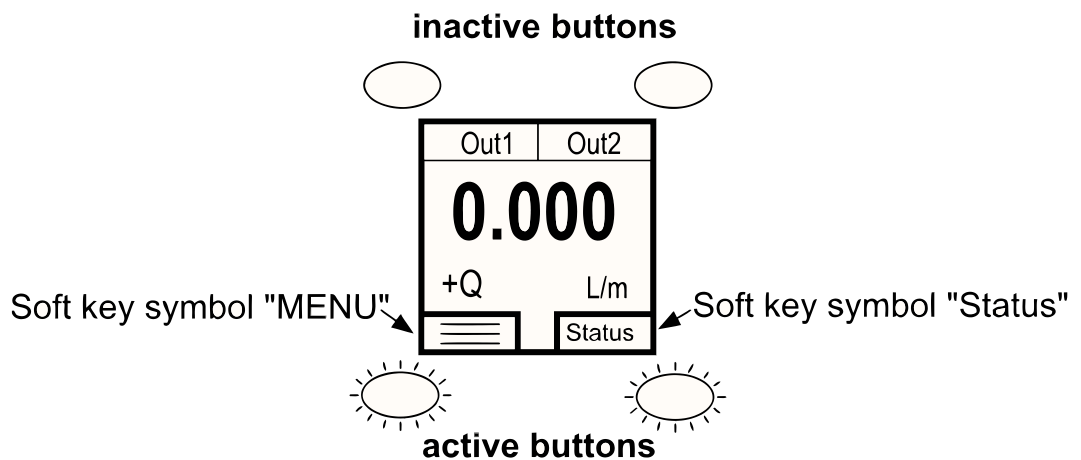

## 9.2 Measuring mode

After applying the supply voltage, the device starts in measuring mode. In this mode, the measured values of the respective measuring variables are continuously recorded; the current instantaneous flow values, temperature values and the volume counter readings are cyclically calculated and displayed according to the type of display.

In addition to the main display, the states and configuration of the outputs are shown in the display. If the corresponding output is configured as an alarm output, the status is also displayed with a green or red background color. If the background color is green, the set threshold value is exceeded; if it is red, the current value is still under threshold.



**Measurement Mode Display Layout 'Single'**

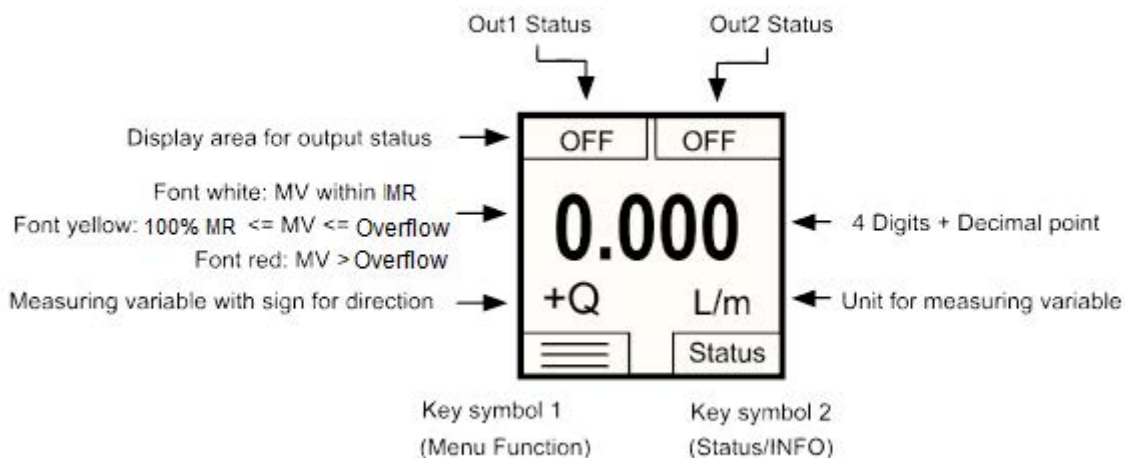

The measurement variables are represented by their corresponding symbols:

Menu entry	Mesuring variables Symbol	Description
Flow	Q	Flow rate
Volume	AC	Accumulated totalizer
Temperature	T	Medium temperature
Part volume	PT	Partial totalizer

The outputs and their status are shown on the display as follows:

Output function OUT1/2	Symbol	Representation
disable	<b>OFF</b>	
Analog output 4-20mA	<b>4-20mA</b>	
Analog output 0-20mA	<b>0-20mA</b>	
Analog output 0-10V	<b>0-10V</b>	
Analog output 2-10V	<b>2-10V</b>	
Alarm output PushPull	<b>SW+-</b>	Background grey/green
Alarm output PNP	<b>SW+</b>	Background grey/green
Alarm output NPN	<b>SW-</b>	Background grey/green
Pulse output	<b>PLS</b>	
Frequency output	<b>FRQ</b>	
Communication mode KofiCom (only OUT1)	<b>KofiCom</b>	Use only for factory service
Communication mode IO-Link (only OUT1)	<b>IO-Link</b>	
Control input	<b>X CTL</b>	"X" symbol of the selected measuring variable

The measured variables flow, temperature and volume counter can in principle be assigned to each output function. The assignment of the respective output is indicated by the display of the symbol of the measuring variable. The representation of the assignment is independent of the set display layout (single, dual).

**Measurement Mode Display Layout 'Dual'**

Out 1 configured as switching output pushpull and assigned to flow

Out 2 configured as analogue output 4-20 mA and assigned to temperature

Font white: MV within MR  
 Font yellow: 100% MR <=MV <=OverFlow  
 Font red: MV >OverFlow

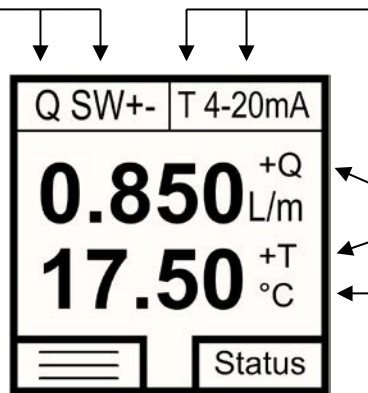

Measuring variables with sign for direction

Unit for measuring variable

Legend:  
 MV - measured value  
 MR - measuring range

Out 1 configured as pulse output and assigned to partial totalizer

Out 2 configured as analogue output 4-20 mA and assigned to temperature

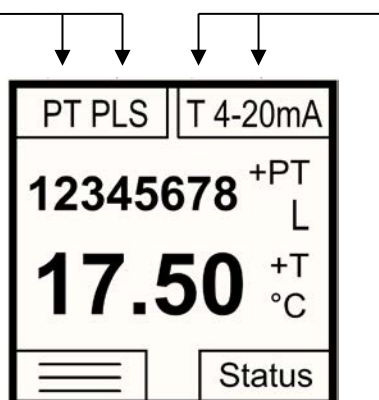

**9.2.1 Display area of the flow meters**

The number of digits displayed on the volume counter display (partial and total volumetric counters) is limited to max. 8 digits. The partial and total volumetric meters therefore have a smaller font size than the flow and temperature display. If the 8-digit display range of the meter is exceeded, this is indicated by the display of 8 minus characters (-----). In this case, the meter reading can no longer be read. The user now has the option of bringing the counter reading back into the display area by changing the volume counter unit.



## 9.3 Menu Mode

In menu mode, all device parameters can be set. The individual parameters are arranged in menu groups by function. While the menu mode is activated, the signal processing and the outputs are still active in the background. However, all display parameters and outputs are updated after exiting the menu mode or in the measuring mode.







**Note:** The menu mode will exit automatically after a certain time without using the buttons, if the parameter "Menu Timeout" is set not equal to "0".

### 9.3.1 Parameter setting

#### 9.3.1.1 List Selection



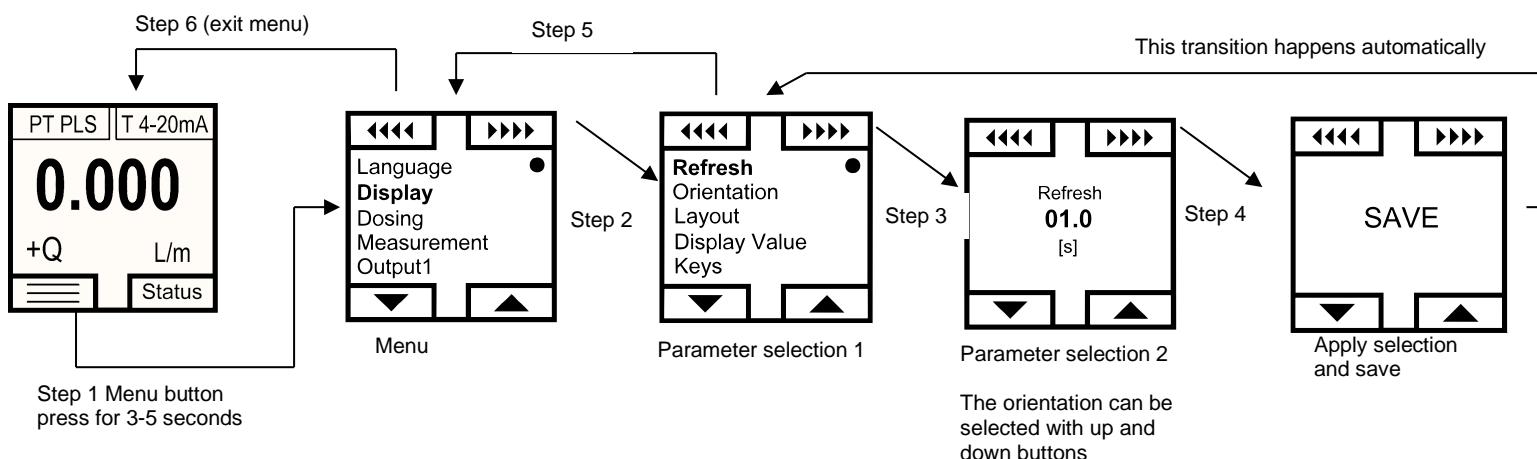

Parameters with predefined selection values are defined by means of list selection. The currently selected menu item is displayed in orange text. The selection can be moved with the   keys, the key  is used to accept the selection.

To activate the menu mode, press the button  for 3-5 seconds. The parameters are divided into main groups and subgroups.

The buttons   are used to select the main groups. In the main menu not all menu groups can be shown on the display at the same time, the list of individual menu items then scrolls up or down when the selection has reached the top or bottom. To choose the selection, the key  is pressed and the device jumps to the corresponding submenu or parameter setting level. For selecting of predefined parameter values  and  are used. After changing the value of the parameter and confirming with  the parameter is saved, and returns to the higher menu level. To return to the main menu or to exit the menu mode, press  (repeatedly).



### 9.3.1.2 Numerical value input

When setting parameters with a numerical value, the assigned unit is always displayed below the input field in square brackets in the input function. The maximum size and the number of decimal places is fixed and cannot be changed. After calling the input function, first the left, outer digit is displayed in orange. This position can now be adjusted either with the keys   in the value from 0 to 9. By pressing the key , the entry point moves to the right and the next digit can be changed. By pressing the key , the editing point can be moved to the left again. If the editing point is on the far right, the set value is saved by pressing the key  again and switched to the higher-level menu function.

## 10. Device configuration

---

### 10.1 Sequence of device parameterization

The flowmeter MIM is pre-configured in factory. Changing the parameters "Measuring range" and "Sensor constant" or "K factor" is therefore not permitted. The adjustment of these parameters is only possible on the part of Kobold-factory. In the event of subsequent changes to volume or throughput units, the dependent parameters are converted and adjusted accordingly. However, the limit parameters of the switching outputs must always be checked and adjusted manually when adjusting volume or throughput units - these are not automatically converted.

An accidental change of the parameterization can be revised by the function "Reset factory setting" in the menu Userservice / Reset.

### 10.2 Language

In this menu item the menu language can be changed in English, German, French or Spanish (standard: English).

Parameter table **language**

Sublevel	parameter level	Sub-parameter level 1	Sub-parameter level 2	Sub-parameter level 3	Description	Value range / value list	Standard value LPM version	Standard value GPM version
English					Selects English as the menu language		<i>English</i>	
Deutsch					Selects German as the menu language			
Francais					Selects French as the menu language			
Espanol					Selects Spanish as the menu language			

## 10.3 Display

### 10.3.1 Refresh

Parameter "Refresh" defines the time interval within which the measuring variables are displayed. The "Refreshrate" can be increased in steps of 0.5 sec. to 10 sec. An increase in the refresh rate time causes an increased "filtering" of the display value.

### 10.3.2 Orientation

With the menu item "Orientation" the display can be rotated either clockwise or counterclockwise in 90 ° increments. As the display rotates, both the display contents and the function of the 4 control buttons are turned.

### 10.3.3 Layout

This parameter can be used to configure the display to either show one measurement variable or two measurement variables.

### 10.3.4 Display value

With the aid of this parameter, the measurement variables provided by the transmitter can be displayed. Depending on the 'Layout' display, either one or two measuring variables can be displayed.

### 10.3.5 Keys HOTKEYs

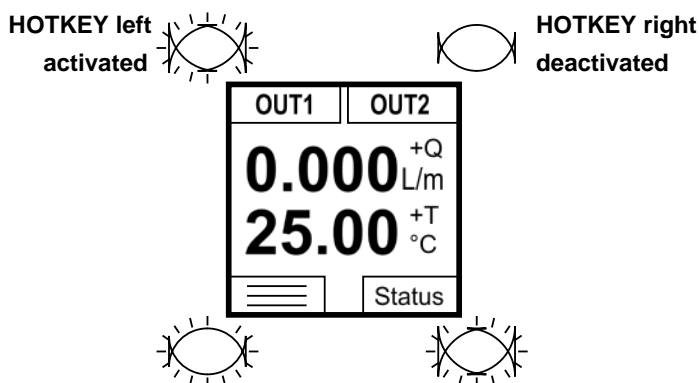

Two independent user keys are available, which can be individually assigned with different display functions. The 2 user keys are available in measurement mode top right and left. If the buttons are activated, they are backlit in blue and the programmed function can be executed by touching.

The following functions are available:

reading	MIN/MAX / Reset	Value display / Reset
flow	Yes / Yes	Yes / No
Temperature	Yes / Yes	Yes / No
Partial quantity counter	Not available	Yes / Yes
Totalizer	Not available	Yes / No

# MIM-

---

The called hotkey function remains permanently activated and can only be left by pressing the key . A direct reset function is available for the MIN / MAX measured value function and the partial quantity counter.

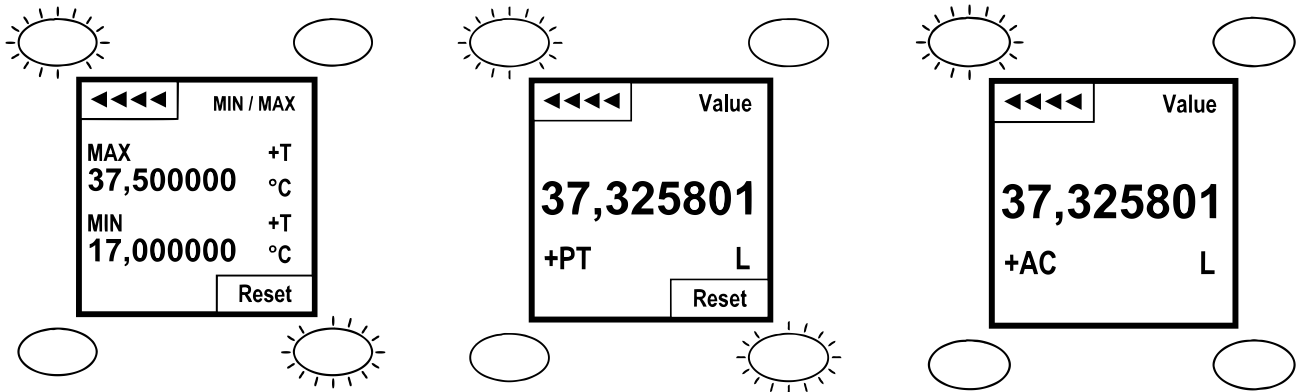

## 10.3.6 Menu Timeout

The menu timeout time defines the time after which the menu function is automatically exited without pressing a key. In the setting "0 s" this function is deactivated and the menu function can only be left by hand by pressing the back key several times.

Parameter table **Display**

Sublevel	Parameter level	Sub-parameter level 1	Sub-parameter level 2	Sub-parameter level 3	Description	Value range/ value list	Default value LPM version	Default value GPM version
Refresh	<i>value input</i>				Sets the display refresh rate	0.5-10 sec	0.5 sec	
Orientation	<i>rotate CW</i>				Rotates the display 90 ° clockwise		Landscape	
	<i>rotate CCW</i>				Rotates the display 90 ° counterclockwise			
Layout	Single				Shows a measured value in the display area		Double	
	Double				Shows two measured value in the display area			
display value	Upper display	<i>list selection</i>			Sets the reading for the upper display	Flow, volume, temperature, part volume	Flow	
	Lower display				Sets the reading for the lower display		Temperature	
Keys	Hotkeys	left	Flow	<i>List selection</i>	Sets the reading and function for the left hotkey	Off, Value, Min / Max	Off	
			Volume					
			Temperature					
			Part volume					
	right	Flow	<i>List selection</i>	Sets the reading and function for the right hotkey	Off, Value, Min / Max	Off		
		Volume						
Temperature								
Part volume								
sensitivity	<i>list selection</i>			Sets the sensitivity for the optical buttons	Low	Low		
Menu Timeout	<i>value input</i>				Defines the time after which the setting menu is automatically exited without pressing a key (0 = deactivated)	0.5 to 60 s	15 s	

## 10.4 Measurement

The Measurement menu lists the measurement variables that the transmitter provides. For magnetic inductive flowmeter, these are:

- Flow
- Volume (total volume counter)
- Temperature
- Part volume

Each measurement variable is still divided into its own submenu. In the submenu, all parameters relating to the respective measuring variables can be adjusted.

## 10.4.1 Flow

### 10.4.1.1 Unit

The displayed unit for the flow measurement can be selected from various predefined standard units. It is also possible to define a user-defined unit ("user"), here the "user unit" must be in LPM (liters / min.) be programmed:

e.g. Unit User = 100 LPM, if Q = 500 LPM then the display shows 5 users.

### 10.4.1.2 Filter function

The measured value filter filters the display value and most electrical output signals (analog outputs / frequency outputs / switching outputs).

A separately adjustable filter is available for each measured value (flow and temperature). In the factory setting, the standard filter with low filtering and active step detector is activated. Volume counters and pulse outputs are generally not filtered.

There are 3 different filter types available, so that a suitable filter functionality is available for as many applications as possible. The time base of the filter function is approx. 20 ms.

Filter type	Filter factor [n]	Step detector	Description
<b>Standard</b>	1 - 250	Yes	Rolling filter type, the size of the filter factor determines the number of temporarily stored and used averaging values.  $MV_{AVG} = \frac{MV_0 + MV_{-1} + \dots + MV_{-n}}{n}$
<b>IIR</b>		No	With this filter type, depending on the filter factor, part of the last measured value average is added to the current average value. The filter corresponds to a digital low-pass filter of the 1st order with an infinite step response. The filter effect achieved is not linear to the parameter filter factor. A high filter effect is only achieved with filter values > 200.  $MV_{AVG} = b * MV_0 + (1 - b) * MV_{AVG-1}$  with $b = \frac{251 - filter\ factor}{250}$
<b>Exp. smoothing</b>		No	The filter type works on the principle of exponential smoothing. The step response has an exponential course. The filter factor is proportional to the response time $t_{90}$ of the step response. This enables the greatest filter effect to be achieved.  $t_{90} \sim filter\ factor * 75ms$  $MV_{AVG} = \frac{MV_{AVG-1} * (n - 1) + MV_0}{n}$
with: $MV_{AVG}$ = filtered measured value, $MV_{AVG-1}$ = last filtered measured value, $MV_0$ = current measured value $MV_{0-1}$ = last measured value			



## Application areas of the filter types

Standard	<p>Standard filter with step detector with fast response time with real changes in measured values. This filter type has a max. time lag of filter factor * 20 ms</p> <p><b>This filter smoothes slight to medium fluctuations in measurement values without the disadvantage of increasing the response time in flow monitoring applications.</b></p>
IIR	<p>Simple digital filter with lag, no step detector</p> <p><b>This filter can be used for slight to medium pulsating fluctuations in measured values. With strong filtering, there is a correspondingly long lag of the filtered measured value in case of real measured value changes. Not suitable for flow monitoring applications with a large filter factor.</b></p>
Exp. Smoothing	<p>Simple smoothing filter with lag, no step detector</p> <p><b>This filter can be used for strong pulsating fluctuations in measured values. With strong filtering, there is a long lag of the filtered measured value with real measured value changes.</b></p> <p><b>The lag can be determined via the filter factor to:</b>  <math>t_{90} \sim \text{filter factor} * 75\text{ms}</math></p> <p><b>Not suitable for flow monitoring applications with a large filter factor.</b></p>

## Step detector (only available with standard filter)

The step detector integrated in the standard filter can detect the tendency of a real change in the measured value and temporarily bridge the filter function after detection of a step in the measured value in order to minimize the step response time. A step (sudden change) in the measured value can be detected both with increasing and with falling measured value. The step detector is set by the step threshold (*JD threshold*) and an interference suppression factor (*JD-ConfFactor*). The behavior at the beginning of the measuring range can be made "interference suppressed" with the parameter *0-ConfFactor*.

<b>JD Threshold</b>	The value of the step threshold is normalized according to the span of the measuring range, the default value 0.1 means 10% of the full scale value.
<b>JD ConfFactor</b>	Defines the factor by which the step threshold must be exceeded in succession without interruption before the step detector actually becomes active. If the end value of the interference suppression counter is not reached, it will be reset. However, if the final value of the counter is reached, the step detector is active and all filter buffers are overwritten with the current measured value.

## 0-ConfFactor

If the measured values are at the start of the measuring range, below which the measured values are set to 0, the zero measured value suppression function may become active. The parameter *0-ConfFactor* defines a counter value, how often the measurement range start value must fall short of in succession and without interruption before the measurement value is actually set to "0". This function serves to stabilize the measured value in the area of the start of the measuring range. Like the step detector, this function works in both directions, i. e. from measuring range => 0 and from 0 => measuring range

### 10.4.1.3 Separation

The parameter Separation sets the flow rate below which the measured value is set to "0". If this function is active, the flow value "0" is shown in blue colour in the display.

### 10.4.1.4 Simulation mode

See section 10.4.5

## 10.4.2 Volume

### 10.4.2.1 Counter type

Absolute:

Regardless of the flow direction, the calculated partial volume is added to the counters.

Bidirectional:

Depending on the flow direction, the calculated partial volume is added or subtracted to the counters. If the measured flow value is negative, the volume value goes down from measurement to measurement (possibly into the negative range).

### Volume measurement by different totalizer types

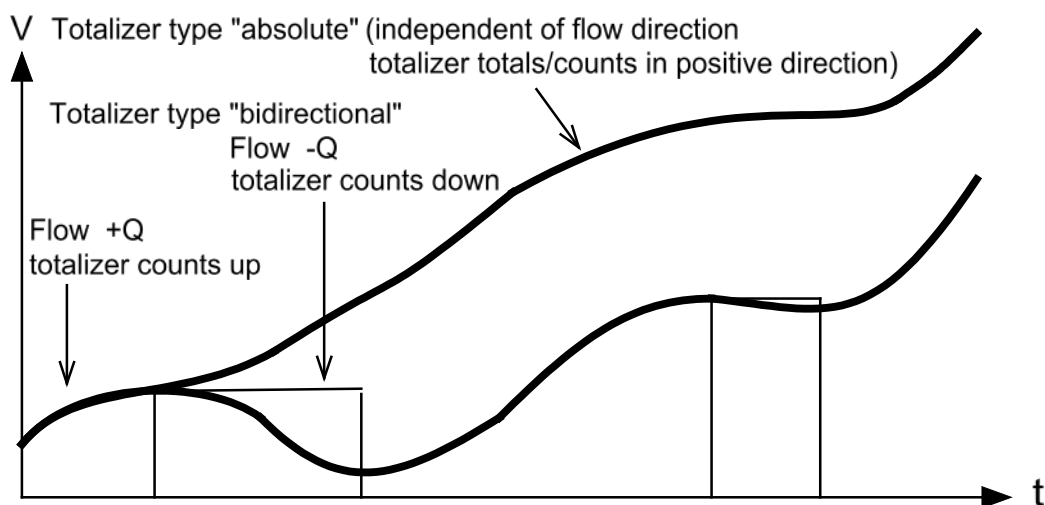

### **10.4.2.2 Unit of the total volume counter**

The parameter "Unit" determines the volume unit of the total volume counter. The listed volume units are available. When changing the volume unit, the current counter reading is converted to the new volume unit.

### **10.4.3 Temperature**

#### **10.4.3.1 Temperature Unit**

The displayed unit for the temperature measurement can be selected from various default units. It is also possible to define a user-defined unit ("user"), in which case the "user unit" must be programmed in °C.

e. g. Unit "user" = 50 °C, if T = 50 °C then the display shows 1 user.

#### **10.4.3.2 Simulation function**

See section 10.4.5

### **10.4.4 Part Volume**

#### **10.4.4.1 Counter type**

Absolute:

Regardless of the flow direction, the calculated partial volume is added to the counters.

Bidirectional:

Depending on the flow direction, the calculated partial volume is added or subtracted to the counters. If the measured flow value is negative, the volume value goes down from measurement to measurement (possibly into the negative range).

#### **10.4.4.2 Unit of the part volume counter**

The parameter "unit" defines the volume unit of all volume meters. The listed volume units are available. When changing the volume unit, the current counter readings are converted to the new volume unit.

#### **10.4.4.3 Memory reset**

In this menu, the part quantity counter can be reset.

#### **10.4.4.4 Simulation function**

See section 10.4.5

### **10.4.5 Simulation function**

With the simulation function, all available measured values can be simulated independently of each other for a limited time. The simulated measured values have full effect on the displays and outputs.

Each simulation started is automatically stopped after the time set in the "Sim Auto Stop Time" (user service) parameter (1 to 30 min) or after the programmed intervals have expired.

The following measured values can be simulated:

## Volume flow, temperature and part quantity counter

The simulation starts as soon as the simulation is activated and the setting menu is exited. The simulation is interrupted or stopped, if the setting menu is called up. There are 3 different simulation types available for each purpose:

### a.) „Triangle“ mode

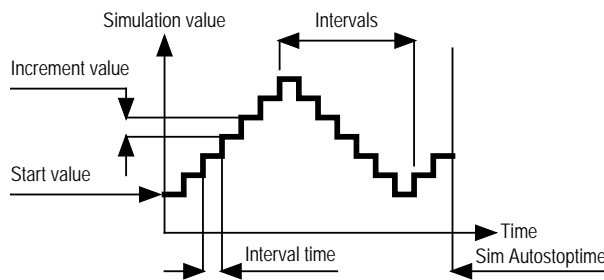

In "Triangle" mode, the simulation value increases continuously in the increment of the parameter "Increment value" and in the interval "Interval time" with the "Start value". After the amount of the parameter "intervals", the simulation value decreases again in the same way, in order to increase again. This

process is repeated continuously until the set time "Sim Auto Stop Time" has expired and the simulation ends.

### b.) "Monotonic" mode

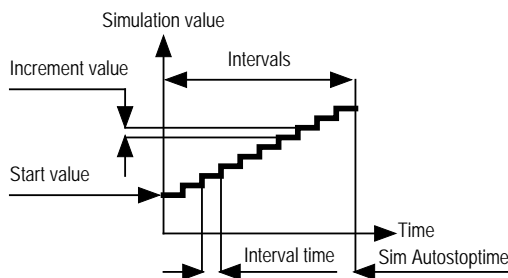

In "Monotonic" mode, the simulation value increases continuously in the step size of the parameter "Increment value" and in the interval "Interval time" with the "Start value". After the amount of "Intervals" or the expiration of "Sim Auto Stop Time", the simulation ends.

### c.) "Static" mode

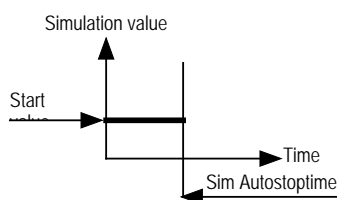

In the "Static" mode, a constant value is output for the measured values flow and temperature. The simulation ends after the set simulation time.

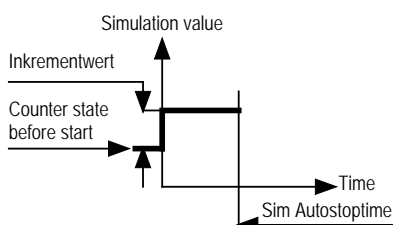

In the "static" simulation for the part quantity counter, the counter is only changed once by the set "increment value" after the start.

When simulating the subset counter, note that in triangle mode, the submenu counter must be in bidirectional mode to achieve the expected effect.

Parameter table **Measuring**

Sublevel	Parameter level	Subparameter level 1	Subparameter level 2	Subparameter level 3	Description	Value range/ value list	Default value <i>LPM</i> version	Default value <i>GPM</i> version
Flow	Unit	<i>List selection</i>			Sets the flow unit	<i>L/m, L/h, m3/h, galUS/m, galUS/h, galUK/m, galUK/h, L/s, mL/s, User</i>	<i>L/m</i>	<i>gals/m</i>
	Filter	Type	<i>List selection</i>		See description	<i>Default / IIR / exp. smoothing</i>	<i>standard</i>	
		Filter factor	<i>Value input</i>			<i>1-250</i>	<i>25</i>	
		JD threshold				<i>0.05 – 1.00 [xFs]</i>	<i>0.1</i>	
		JD-ConfFactor				<i>1-25</i>	<i>1</i>	
		0-ConfFactor				<i>1-25</i>	<i>1</i>	
	separation	<i>value input</i>			Sets the value for the low flow cutoff	$0 \leq \text{Value} \leq \text{Range start}$	<i>Range start</i>	
Simulation mode	<i>See table Simulation mode</i>							
Volume	Counter Type	<i>absolute/ bidirectional</i>			Sets the counting mode		<i>absolute</i>	
	Unit	<i>List selection</i>			Sets the volume unit	<i>ml, L, m3, galUS, galUK, User</i>	<i>L</i>	<i>L</i>
Temperature	Unit	<i>List selection</i>			Sets the temperature unit	<i>°C, °F, User</i>	<i>°C</i>	<i>°C</i>
	Filter	Type	<i>List selection</i>		See description	<i>Default / IIR / exp. smoothing</i>	<i>standard</i>	
		Filter factor	<i>Value input</i>			<i>1-250</i>	<i>1</i>	
		JD threshold				<i>0.05 – 1.00 [xFs]</i>	<i>0.1</i>	
		JD-ConfFactor				<i>1-25</i>	<i>1</i>	
		0-ConfFactor				<i>1-25</i>	<i>1</i>	
	Simulations-modus	<i>See table Simulation mode</i>						
Part volume	Counter Type	<i>absolute/ bidirectional</i>			Sets the counting mode		<i>absolute</i>	
	Unit	<i>List selection</i>			Sets the volume unit	<i>ml, L, m3, galUS, galUK, User</i>	<i>L</i>	<i>galUs</i>
	memory reset	<i>Yes/No</i>			Sets the counter value to "0"			
	Simulation mode	<i>See table Simulation mode</i>						

## 10.5 Dosing function

see section 12

## 10.6 Outputs

The MIM flowmeter provides a total of 2 outputs that are freely configurable. The configuration of the outputs (output 1 and output 2) is done via a wizard function. The wizard function guides the user step by step through all necessary settings.

### Steps:

- Select output
- Selection of the source or the measurement variable to be output (Flow, Volume, Temperature, Part volume)
- Selection of an output type (4-20 mA, 0-20 mA, 0-10 V, 2-10 V, alarm, pulse, frequency output, IO-Link, control input)
- Setting the output (scaling, thresholds)
- Save the configuration

The different output types are optimized for different types of applications. The following table contains the application recommendations for the different output types. If the outputs are not used according to the recommendations, measurement deviations can occur and the desired functionality is not achieved.

Application	Output type			
	Analog output (all variants)	Frequency output	Pulse output	Alarm output
Telemetry device	✓	✓		
Limit monitoring				✓
Window monitoring				✓
External dosage			✓	
External volumetric count			✓	

Application table output types

### 10.6.1 Alarm output

The alarm outputs can be parameterized with a limit value function or a window function.

#### 10.6.1.1 Function

The parameter "*Function*" defines the basic function. Limit value function and window function are available.

Limit value function: The switching output is **active** if the current flow rate value is above the switching threshold. It remains **active** until the measured value has fallen below the switching threshold minus the hysteresis.

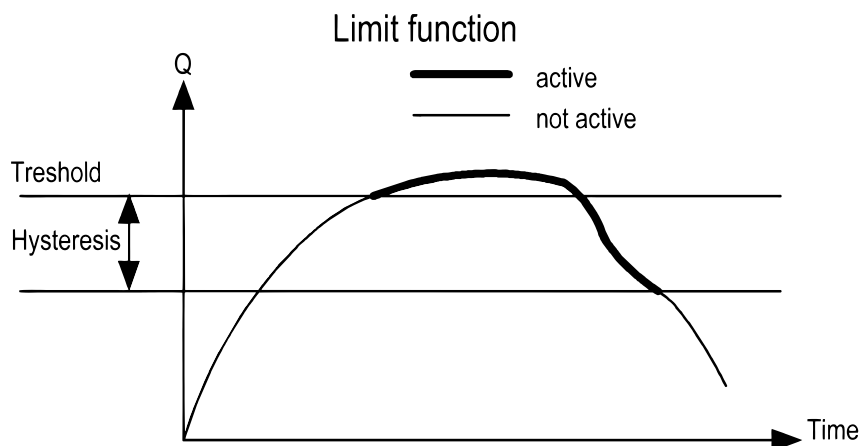

**Window function:** The switching output is **active** if the current flow measured value is outside a window, which is formed by the "*switching threshold*" and the "*lower threshold*". The monitored window decreases in each case by the amount of the "*hysteresis*". If the switching output is to be **active** within the window, the parameter "*switching function*" must be changed from N/O to N/C.

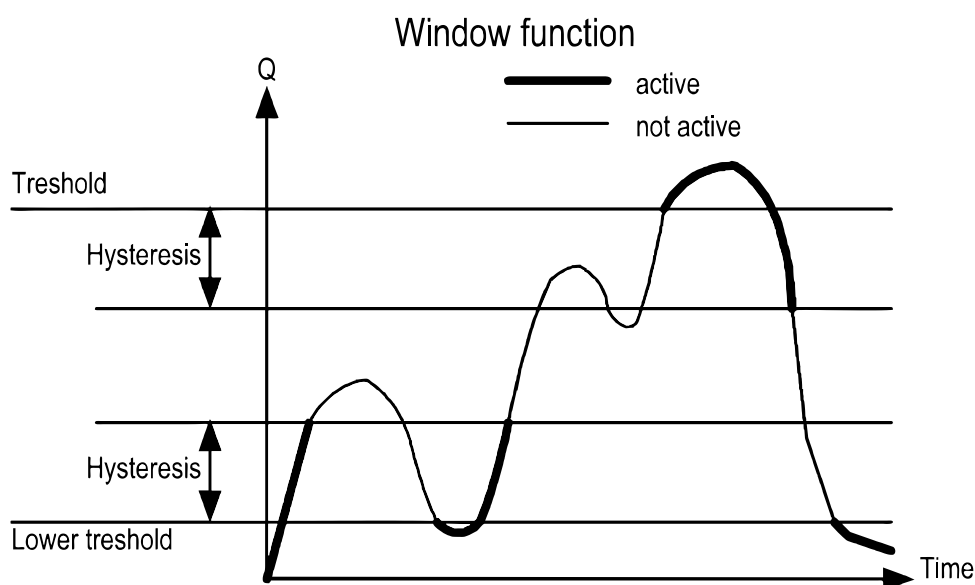

#### 10.6.1.2 Output type

The parameter "*Output type*" defines the function of the transistor output. NPN, PNP or PP (push-pull) output types are available. The push-pull type combines NPN and PNP and is therefore the best choice for most circuits. All outputs are short circuit and overload protected.

#### 10.6.1.3 Switching function

The "*switching function*" defines the mode of operation of the outputs. In the default setting "normally open", the output becomes active (switched) when the measured value exceeds the switching threshold. This feature is also referred to as N.O. In the "*Normally closed*" setting, the output below the switching threshold is already active and is deactivated when the measured value exceeds the switching threshold. This function is also referred to as N.C.

**10.6.1.4 Threshold**

Threshold for limit value function and upper window point for window function.

**10.6.1.5 Lower threshold**

The "lower threshold" defines the lower limit when using the window function. When using the limit value function, this parameter remains ineffective.

The switching thresholds can be set both positive and negative.

**10.6.1.6 Hysteresis**

The appropriate setting of the "hysteresis" parameter ensures that the switching outputs do not switch on and off continuously when the current measured value fluctuates around the switching threshold. The hysteresis value should therefore always be greater than the real measured value fluctuations. As a result, a targeted suppression can be achieved.

**10.6.1.7 Filter factor (delay)**

Further suppression of the switching outputs of fluctuating measuring signals can be achieved by setting the parameter "Filter factor". If this parameter is selected greater than 0, the switching of the output will be delayed accordingly. The "Supp direction" parameter determines whether the deceleration is to be effective when the switching threshold is exceeded or not reached (alternatively in both directions). "High" means that the delay is active when the measured value exceeds the switching threshold, "Down" means corresponding effect when the switching threshold is undershot.

The measured value must stay continuously below or above the switching threshold with the count of [SUPPRESSIONFACTOR] before the switching output will be activated. With this function sporadic limit value overruns can be safely suppressed.

According to the value of the parameter "filter factor", the response time of the output generally increases.

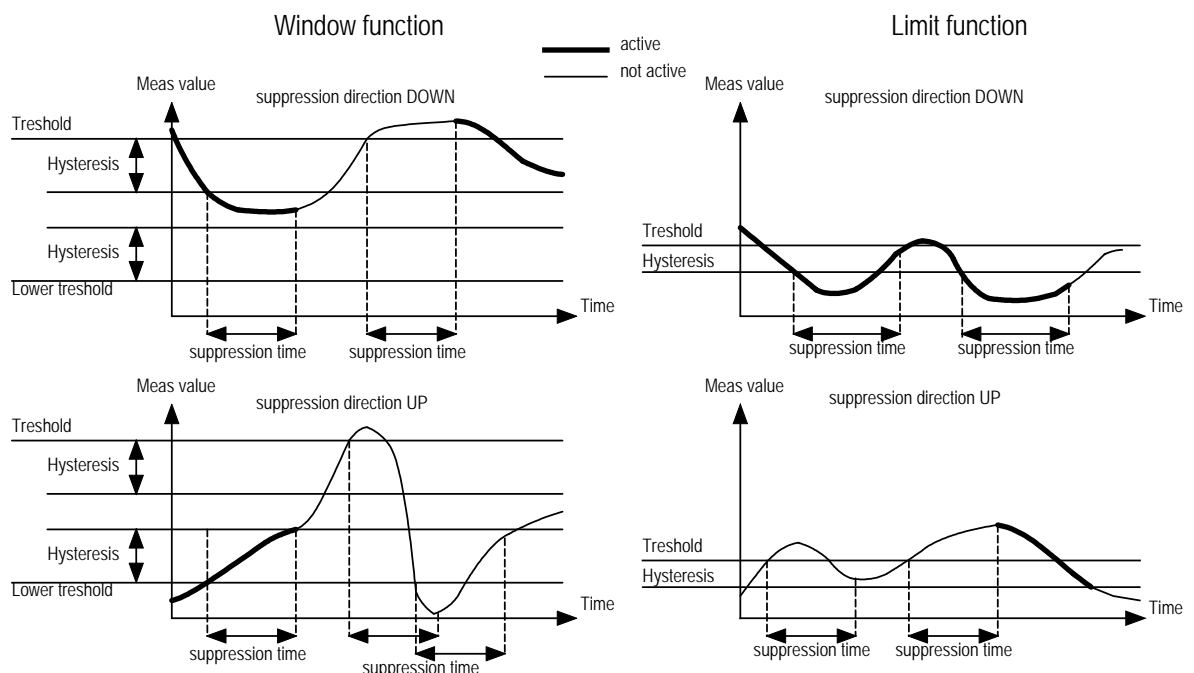

Examples of the effect of the switching delay for window and limit function



## 10.6.2 Analogue outputs

### 10.6.2.1 Current output 0(4)-20 mA

The current output gives a measured variable (flow or temperature) in scaled form as a 0 (4) -20 mA current signal.

The current output is scaled via the "Value 20 mA "and" Value 4 mA "(with current output 0-20 mA "Value 0 mA"). By default, the "Value 20 mA" parameter is set to the value for the end of the measuring range, but can be parameterized as desired within the measuring range, but always bigger than the measuring range start value. The parameters "Value 4 mA" / "Value 0 mA" define the measured values for the starting current value, which may also be set freely in the measuring range. Note 1: If the value is set smaller than the end of the measuring range, the accuracy of the output voltage value is reduced.

Note 2: The burden on the current output must not exceed 500  $\Omega$ .

### 10.6.2.2 Voltage output 0-10 V / 2-10 V

The voltage output outputs a measurement variable (flow or temperature) in scaled form as a 0-10 V / 2-10 V voltage signal.

The scaling of the voltage output is done via the parameter "Value 10 V" and "Value 0 V". By default, the "Value 10 V" parameter is set to the value for the end of the measuring range, but can be parameterized as desired within the measuring range, but must always be bigger than the measuring range start value.

The parameters "Value 0 V" and "Value 2 V" define the measured values for the start voltage value, which may also be freely set in the measuring range.

Note 1: If the value is set smaller than the end of the measuring range, the resolution and accuracy of the output voltage value are reduced.

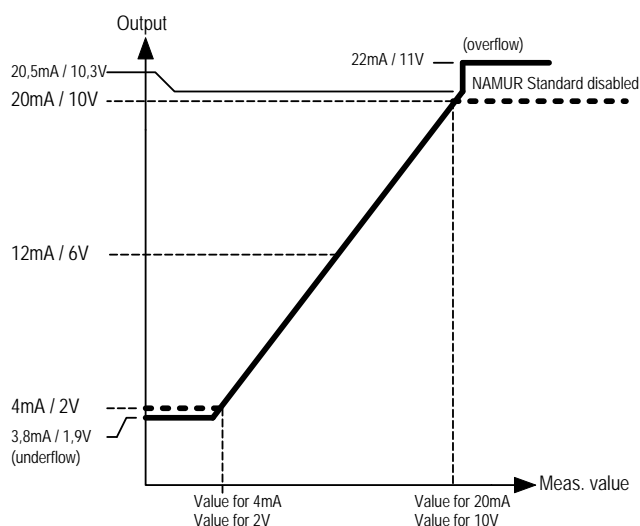

Output behavior 4-20 mA and 2-10 V

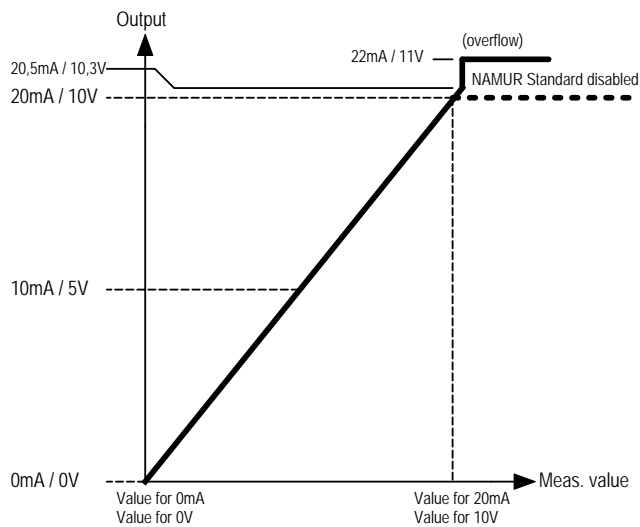

Output behaviour 0-20 mA and 0-10 V

### 10.6.2.3 Activation of behaviour according to NAMUR recommendation NE43

For all analogue outputs (current and voltage), the output behaviour can be activated according to NAMUR recommendation NE43. When the function is activated, e.g. the linear output of the 4 to 20 mA signals to 3.8 to 20.5 mA. Above 20.5 mA, the current value jumps to approx. 22 mA to signalise a measuring range overshoot. Current output values between 3.8 and 4.0 mA indicate that the measuring range is undershot. The output of approximately 3.6 mA signals a device or process fault (e.g., empty tube signalling).

### 10.6.3 Pulse output

MIM flowmeter provides a scalable pulse output. When the pulse output is activated, the cyclically incoming volume is available as a pulse train at the output. The pulse width of the pulse output is constant and can be set in a range of 1 ms up to 20 s. The pulse output is updated in a cycle of 20 ms. At the beginning of each update, it is determined how much volume has been accumulated during the previous update period. According to this amount and the set pulse volume, the corresponding amount of pulses is available as a pulse train at the output.



**The pulse signal is not suitable for determining the volume flow with an external frequency measurement.**



**The reaction time of the pulse output is directly dependent on the flow parameter "separation" (cutoff). The shortest reaction time is reached if this parameter is set to the value "0.0" (factory setting: start of measuring range).**

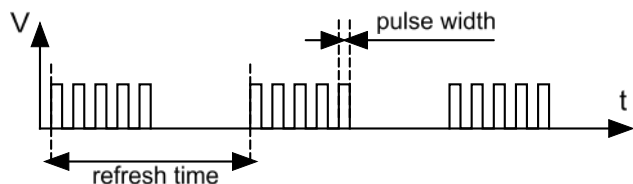

The electrical output type of the pulse output is push-pull, therefore HIGH and LOW are actively switched through at the output.

**Pulse output function with different totalizer types**

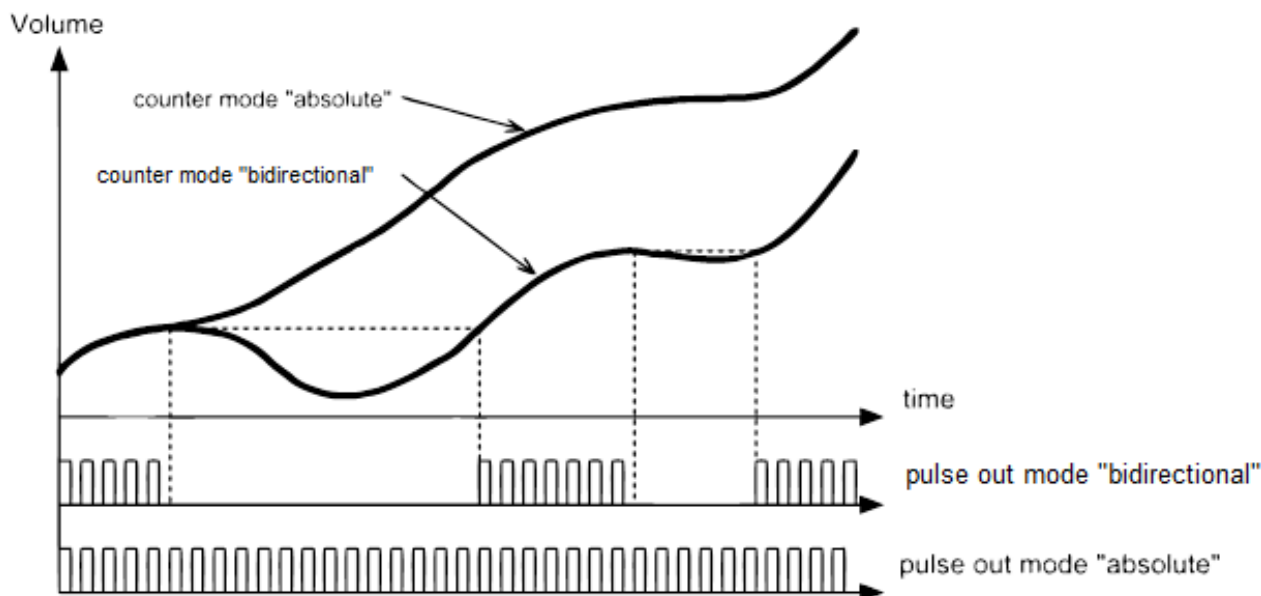

**Behavior on OVERFLOW:**

If the volumetric flow measurement is in the OVERFLOW range, the pulse output is switched off and a constant HIGH level is applied to the output.

Generation of the output pulse train:

The pulse volume (pulse value volume per output pulse) can be set freely within wide ranges. Together with the adjustable pulse width and the measuring range of the device there is a limited range in which the pulse output is instantaneous.

This is the case if the following condition is met:

$$\frac{\text{MRE-Measurement Range End [L/min]} * \text{pulse width [ms]}}{\text{pulse volume [L]}} \leq 22500$$

or

$$\text{Pulse volume [L]} \geq \frac{\text{MRE-Measurement Range End [L/min]} * \text{pulse width [ms]}}{22500}$$

If the condition is not met, there may be a time lag of the pulse output. This is particularly undesirable if dosing tasks are to be performed with the pulse signal.

The following table shows the different combinations of pulse volume and pulse width for the different measuring ranges, in which the above limiting condition is fulfilled.

Measuring range [LPM]	pulse width [ms]	min. pulse volume [L]	max. pulse rate [pulse/L]
100	20	0.08889	11.25
	10	0.04444	22.50
	5	0.02222	45.00
	1	0.00444	225.00
50	20	0.04444	22.50
	10	0.02222	45.00
	5	0.01111	90.00
	1	0.00222	450.00
25	20	0.02222	45.00
	10	0.01111	90.00
	5	0.00556	180.00
	1	0.00111	900.00
10	20	0.00889	112.50
	10	0.00444	225.00
	5	0.00222	450.00
	1	0.00044	2250.00
03	20	0.0026	375
	10	0.0013	750
	5	0.0006	1500
	1	0.0001	7500

The pulse output only takes place in measuring mode; while the menu mode is active no pulses are given. The pulses accumulated in the menu mode are output as soon as the measuring mode is active again. Depending on the situation, this can also lead to a longer pulse lag.

### 10.6.3.1 Pulse volume

The parameter "Pulse volume" is defined as volume quantity for the output of a pulse; the unit is corresponding to [volume quantity / pulse]. The likewise common pulse rate [pulse / volume unit] corresponds to the reciprocal of the pulse volume.  
Example: Desired pulse rate at the output 10 pulses / liter => pulse volume = 1 / pulse rate = 1/10 L = 0.1 L

### 10.6.3.2 Volume unit

The volume unit to be set is the input unit for the "Pulse volume" parameter. The definition of a user-defined unit ("user") is also possible and can be programmed in "liters".

Example:

Unit "user" = 10 [L], pulse volume = 2 [user]

The total pulse volume would be 2 \* 10 = 20 [L]. After 20 liters, a pulse is output.

### 10.6.3.1 Pulse width

The pulse width of the pulse output is flexibly adjustable from 1 to 20,000 ms.

### 10.6.4 Frequency output

The MIM flowmeter provides a scalable frequency output. When this output is activated, the measurement variable (flow or temperature) associated with the frequency output is output proportionally as a frequency with a 1: 1 pulse / pause duration. The output frequency at the end of the measuring range can be set (parameter "maximum frequency"). With the two parameters "Value for 0 Hz" and "Value for max Hz", the frequency output in the measuring range can be freely scaled.

#### Behavior on OVERFLOW:

If the measured value is in the overflow range, a constant frequency is output.

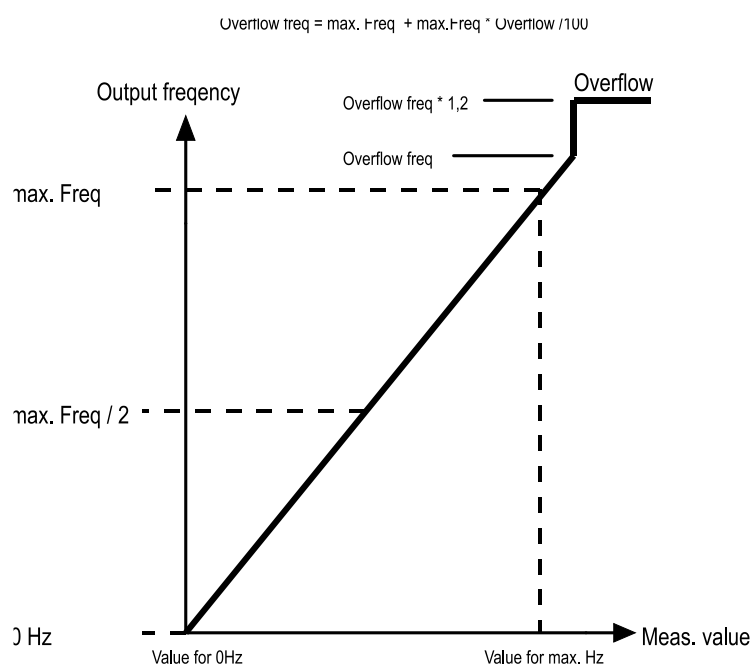

Output behavior Frequency output

### 10.6.5 Control input

Output 1 can be configured as a control input. This can reset the MIN / MAX memory or the partial quantity counter depending on the assigned measurement variable.

Function	Measurement variable	Control pulse duration
MIN/MAX Reset	Flow, temperature	0.5s < t <sub>high</sub> < 4s
Part volume counter reset	Part volume counter	0.5s < t <sub>high</sub> < 4s

Parameter table **Output 1/2 – Flow**

Sub-parameter level 1	Sub-parameter level 2	Sub-parameter level 3	Description	Value range / value list	Standard value LPM version	Standard value GPM version
<i>disabled</i>			<i>Output deactivated</i>		<i>IO-Link</i>	
Alarm output	Function	<i>List selection</i>	Sets the basic function	<i>Limit function / window function</i>	<i>Limit function</i>	
	Output		Sets the electr. Output	<i>NPN/PNP/PP</i>	<i>NPN</i>	
	switching function		Set the log. switching function	<i>NO/NC</i>	<i>NO</i>	
	threshold	<i>Value input</i>	Sets the switching threshold	<i>MB start ≤ value ≤ Full scale</i>	<i>1</i>	
	lower threshold		Sets the lower threshold for window function	<i>Value threshold ≤ value ≤ MB start</i>	<i>1</i>	
	hysteresis		Defines the switching hysteresis	<i>0 ≤ value ≤ (MB end – MB start)</i>	<i>1</i>	
	filter factor		Factor for the switching delay x100 ms	<i>0x ≤ value ≤ 60x</i>	<i>0</i>	
	direction		Defines the effective direction of the switching delay	<i>Up / Down / Both</i>	<i>Down</i>	
4-20 mA	NAMUR Standard	<i>Value input</i>	Activates the behaviour according to NAMUR NE43	<i>activated / deactivated</i>	<i>deactivated</i>	
	<i>Value 4 mA</i>		Measured value for 4 mA output	<i>MB-start ≤ value ≤ Wert 20 mA</i>	<i>0</i>	
	<i>Value 20 mA</i>		Measured value for 20 mA output	<i>Value 4 mA ≤ value ≤ Full scale</i>	<i>100</i>	
0-20 mA	NAMUR Standard		Activates the behaviour according to NAMUR NE43	<i>activated / deactivated</i>	<i>deactivated</i>	
	<i>Value 0 mA</i>		Measured value for 0 mA output	<i>MB start ≤ value ≤ value 20 mA</i>	<i>0</i>	
	<i>Value 20 mA</i>		Measured value for 20 mA output	<i>Value for 0 mA ≤ value ≤ Full scale</i>	<i>100</i>	
2-10 V	NAMUR Standard		Activates the behaviour according to NAMUR NE43	<i>activated / deactivated</i>	<i>deactivated</i>	
	<i>Value 2 V</i>		Measured value for 2 V output	<i>MB start ≤ value ≤ value 10 V</i>	<i>0</i>	
	<i>Value 10 V</i>		Measured value for 10 V output	<i>Value for 2 V ≤ value ≤ Full scale</i>	<i>100</i>	
0-10 V	NAMUR Standard	Activates the behaviour according to NAMUR NE43	<i>activated / deactivated</i>	<i>deactivated</i>		
	<i>Value 0 V</i>	Measured value for 0 V output	<i>MB start ≤ value ≤ value 10 V</i>	<i>0</i>		
	<i>Value 10 V</i>	Measured value for 10 V output	<i>Value for 0 V ≤ value ≤ Full scale</i>	<i>100</i>		

Sub-parameter level 1	Sub-parameter level 2	Sub-parameter level 3	Description	Value range / value list	Standard value LPM version	Standard value GPM version
Frequency output	<i>max. frequency</i>	<i>Value input</i>	Frequency output at "value at max. Hz"	50-1000 Hz	500 Hz	
	<i>overflow</i>		Overflow value in % of the value "max.frequency"	1-100 [%]	1%	
	<i>Value at 0 Hz</i>		Value at 0 Hz	$MB\ start \leq value \leq value\ at\ max.\ Hz$	0	
	<i>Value at max. Hz</i>		Value at "maximum frequency"	$Value\ for\ 0\ Hz < value \leq Full\ scale$	100	
Control input (only output 1)			Control function for MIN / MAX memory reset	OFF, memory reset	Aus	
KofiCom	<i>Factory calibration mode on output 1</i>					
IO-Link	<i>This mode activates the IO-Link function on output 1(standard factory setting)</i>					

## Parameter table Output 1/2 – Volume

Sub-parameter level 1	Sub-parameter level 2	Sub-parameter level 3	Description	Value range / value list	Standard value LPM version	Standard value GPM version
<i>disabled</i>			<i>Output deactivated</i>		<i>disabled</i>	
Pulse output	Pulse unit	<i>List selection</i>	Sets the Pulse Volume for Pulse Volume	<i>ml, L, m3, galUS, galUK, User</i>	<i>L</i>	<i>galUs</i>
	Pulse volume	<i>value input</i>	Sets the value for the pulse volume	0.001-999	1	
	Pulse width		Sets the pulse width	1-20.000	1 ms	
KofiCom	<i>Factory calibration mode on output 1</i>					
IO-Link	<i>This mode activates the IO-Link function on output 1</i>					

Parameter table **Output 1/2 – Temperature**

Sub-parameter level 1	Sub-parameter level 2	Sub-parameter level 3	Description	Value range / value list	Standard value LPM version	Standard value GPM version
<i>disabled</i>			<i>Output deactivated</i>		<i>disabled</i>	
Alarm output	Function	<i>List selection</i>	Sets the basic function	<i>Limit function / window function</i>	<i>Limit function</i>	
	Output		Sets the electr. Output	<i>NPN/PNP/PP</i>	<i>NPN</i>	
	Switching function		Sets the log. switching function	<i>NO/NC</i>	<i>NO</i>	
	Threshold	<i>Value input</i>	Sets the switching threshold	<i>MB start ≤ value ≤ Full scale</i>	<i>1</i>	
	lower threshold		Sets the lower threshold for window function	<i>Value threshold ≤ value ≤ MB start</i>	<i>1</i>	
	Hysteresis		Defines the switching hysteresis	<i>0 ≤ value ≤ (MB end – MB start)</i>	<i>1</i>	
	Filter factor		Factor for the switching delay x100 ms	<i>0x ≤ value ≤ 60x</i>	<i>0</i>	
	Direction		Defines the effective direction of the switching delay	<i>Up / Down / Both</i>	<i>Down</i>	
4-20 mA	<i>Value 4 mA</i>	<i>Value input</i>	Measured value for 4 mA output	<i>MB start ≤ value ≤ value 20 mA</i>	<i>0</i>	
	<i>Value 20 mA</i>		Measured value for 20 mA output	<i>Value 4 mA ≤ value ≤ Full scale</i>	<i>100</i>	
0-20 mA	<i>Value 0 mA</i>		Measured value for 0 mA output	<i>MB start ≤ value ≤ value 20 mA</i>	<i>0</i>	
	<i>Value 20 mA</i>		Measured value for 20 mA output	<i>Value 0 mA ≤ value ≤ Full scale</i>	<i>100</i>	
2-10 V	<i>Value 2 V</i>		Measured value for 2 V output	<i>MB start ≤ value ≤ value 10 V</i>	<i>0</i>	
	<i>Value 10 V</i>		Measured value for 10 V output	<i>Value 2 V ≤ value ≤ Full scale</i>	<i>100</i>	
0-10 V	<i>Value 0 V</i>		Measured value for 0 V output	<i>MB start ≤ value ≤ value 10 V</i>	<i>0</i>	
	<i>Value 10 V</i>		Measured value for 10 V output	<i>Value 0 V ≤ value ≤ Full scale</i>	<i>100</i>	
Frequency output	<i>max. frequency</i>	<i>Value input</i>	Frequency output at "value at max. Hz"	<i>50-1000 Hz</i>	<i>500 Hz</i>	
	<i>Overflow</i>		Overflow value in % of the "value at max. frequency"	<i>1-100 [%]</i>	<i>1%</i>	
	<i>Value at 0 Hz</i>		Value at 0 Hz	<i>MB start ≤ value ≤ value for max. Hz</i>	<i>0</i>	
	<i>Value at max. Hz</i>		Value at "max. frequency"	<i>Value for 0 Hz &lt;value ≤ Full scale</i>	<i>100</i>	
Control input (only OUT1)			Control function for MIN / MAX memory reset	<i>OFF, memory reset</i>	<i>OFF</i>	
KofiCom (only OUT1)	<i>Factory calibration mode on output 1</i>					
IO-Link (only OUT1)	<i>This mode activates the IO-Link function on output 1</i>					



Parameter table **Output 1/2 – Part volume**

Sub-parameter level 1	Sub-parameter level 2	Sub-parameter level 3	Description	Value range / value list	Standard value LPM version	Standard value GPM version
<i>Disabled</i>			<i>Output deactivated</i>		<i>disabled</i>	
Pulse output	Pulse unit	<i>List selection</i>	Sets the Pulse Volume for Pulse Volume	<i>ml, L, m3, galUS, galUK, User</i>	<i>L</i>	<i>galUs</i>
	Pulse volume	<i>Value input</i>	Sets the value for the pulse volume	<i>0-999</i>	<i>1</i>	
	Pulse width		Sets the pulse width	<i>1-20.000</i>	<i>1 ms</i>	
Control input (only Out1)			Control function for counter reset	<i>OFF, memory reset</i>	<i>Off</i>	
KofiCom (only OUT1)	<i>Factory calibration mode on output 1</i>					
IO-Link (only OUT1)	<i>This mode activates the IO-Link function on output 1</i>					

## 10.7 User service

The user service provides the user with a reset function and password setting. Together with the activation of a user password, therefore, the menu access for the user on the part of a master user can be blocked.

### 10.7.1 User service / change password

In the factory setting the user password is set to "00000", the user functions are thus freely accessible. If the user password is changed to other than "00000", the password prompt becomes active the next time the user menu is entered. If the set password is no longer known, a master password can be requested from KOBOLD.

### 10.7.2 User service / factory setting

By activating this function, the user can reset the device to the factory settings. Any user settings will then be lost and the device will be back in delivery condition.

Parameter table **User menu**

Sublevel	Parameter level	Description	Value range / value list	Standard value LPM version	Standard value GPM version
Password	value input	Protects the user service menu by password prompting if the password is not "00000"	<i>00000-99999</i>	<i>00000</i>	
Factory reset	Yes / No	Resets the device to factory settings			
Menu lock	unlocked / closed	<i>With "locked", the menu access only takes place via the password prompt</i>	unlocked / closed	<i>unlocked</i>	
Sim Autostop	Value input	<i>Sets the time for how long the simulation mode remains active</i>	<i>1 - 31 min.</i>	<i>10 min.</i>	

## 10.8 Service / Factory service

The factory service function is password protected and not accessible to the user.

## 10.9 Info

### 10.9.1 General

This info option displays the measuring ranges of the device for flow and temperature.

### 10.9.2 Version

This info option displays the hardware and software version of the device.

### 10.9.3 QR code link to the user manual

Here a QR code is displayed. With a suitable smartphone, the code can be scanned and the user manual in English language downloaded directly as a PDF and opened.

The smartphone must have a QR code scanning app and a PDF reader app installed, as well as an internet connection.

#### Parameter table Info

Menu level	Sublevel	Description
Info	General	Displays the measuring ranges of the device
	Version	Displays the hardware and software version
	Manual	Displays the QR code to download the instruction manual

## 10.10 Device default settings

The MIM flowmeter is factory set and unloaded with the following configuration:

Display - Dual

Upper display - Flow

Lower display - Temperature

Out 1: **IOLINK**

Out 2: **OFF**

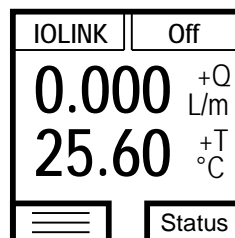

#### **Important note for MIM devices powered with software REV190320:**

If output 1 should be operated as a current output, the conversion of the output from IOLINK (factory setting) to current output must be made before the electrical connection of the current loop. If this is not observed, the access to the menu function is blocked and the device can no longer be configured.

## 11. Status

The electromagnetic flowmeter can detect and display various device or application errors.

If there is a status or error message, the STATUS symbol in the display alternately flashes orange / red. To call up the status / error information, the status key must be pressed, then the status window that appears then lists all the messages that have accumulated up to this point in time. By pressing the  $\cdot \leftarrow \leftarrow \leftarrow \cdot$  key, the user confirms the knowledge of the displayed errors, the status memory is cleared and the status window is closed. If one of the displayed errors persists, it will be reported again by flashing the status icon.

The following status / error messages are generated:

Display text	Description	Debugging
<i>Empty Pipe</i>	Measuring tube is not completely filled with medium or medium with too low conductivity is used.	Check the filling of the measuring circuit or conductivity of the medium (> 20 $\mu\text{s} / \text{cm}$ )
<i>Temp Sens Error</i>	Error in the temperature measuring circuit	Repair by KOBOLD Service necessary
<i>Meas saturated</i>	Flow measuring circuit overdriven	Reduce flow rate
<i>No Subslave</i>	Internal hardware error	Repair by KOBOLD Service necessary
<i>Simulation</i>	Simulation function active	-

## 12. Dosing function

The standard MIM provides a simple dosing function. This can be permanently activated or deactivated in the settings menu under the menu item "dosing". If the dosing function is activated, fixed functions are assigned to the 2 outputs which cannot be changed as long as the dosing function is activated:

OUT2 (Pin 2): Dosing output in push pull configuration  
 OUT1 (Pin 4): Control input for START/STOP/RESET function



### Attention!

When the control input is used, then OUT1 (connection pin 4) must be always polarised, either to the 24 Vdc or to the GND (pin 3). When using a mechanical button that switches the supply voltage to the control input, a 10 kOhm pull-down resistor is recommended. The control input must not be left open!



When using the dosing function, it is recommended to set the flow parameter "Separation" (Cutoff) to the value "0.0" in order to achieve the most accurate results possible (factory setting: start of measuring range).

If the dosing function is deactivated, both outputs are switched to OFF (deactivated) by default, but can then be freely configured again.

### Dosing Edit Menu

### Main Display Dosing

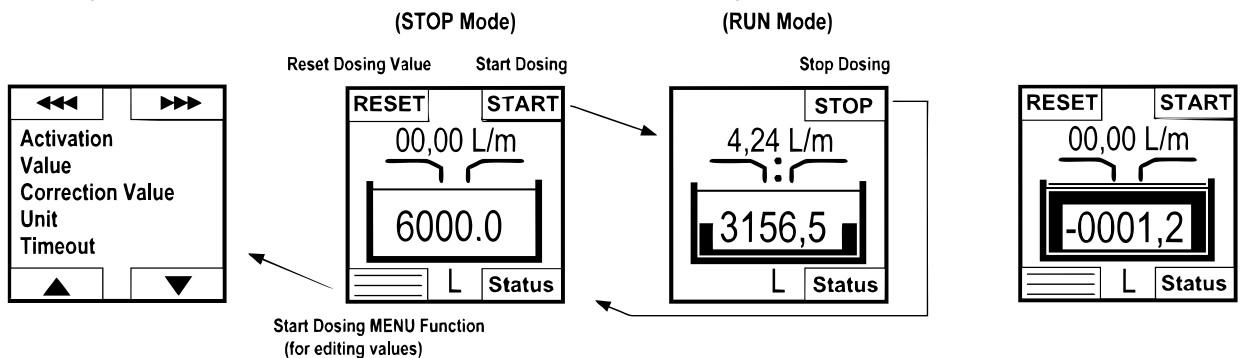

In the main display of the dosing function, the quantity to be dosed in a preselectable unit and the current flow value are displayed on the one hand. The progress of the dosing process is additionally represented by a graphic animation in which the container shown fills in percent and also overflow is shown.

Softkey buttons: All softkey buttons in dosing mode must be held down by the user for at least 2 seconds and then released again for the corresponding function to be triggered. This is to avoid accidental operation.

Control input: Connection OUT1 can be used as a control input for the functions Start / Stop / Reset when the dosing function is activated.

Function	Conditions	Control pulsetime
START	Stop Modus	$0.5 \text{ s} < t_{\text{high}} < 4 \text{ s}$
STOP	Run Modus	$0.5 \text{ s} < t_{\text{high}} < 4 \text{ s}$
RESET	Stop Modus	$t_{\text{high}} > 5 \text{ s}$

### START of dosing:

Dosing can be started either by triggering the "START" softkey or by applying a high pulse to the control input.

After the START function has been triggered, the dosing output is switched to active (High) and the dosing counter is counted down in the standard direction when flow is present.

If the dosing process is stopped incompletely by hand, it can be restarted by the START function.

### STOP of dosing

If the dosing process is started, it can be stopped or interrupted by the STOP function. Resumption of dosing to reach the total dosing quantity is possible by START.

Like the START function, the STOP function can be remotely controlled by the control input.

### RESETTING the dosing value

If the dosing process is finished or stopped, the dosing quantity can be reset to the default value by the function RESET.

This function can also be triggered at the control input.

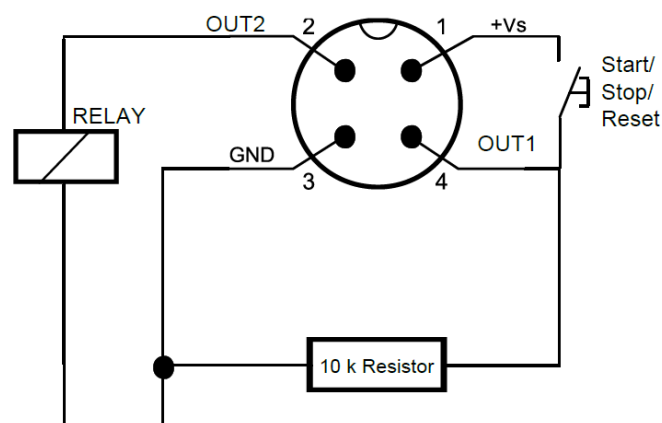
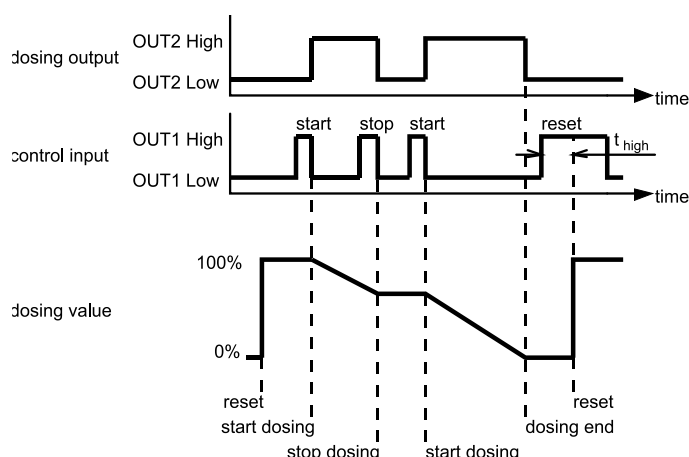

## Description of dosing parameters

### **Dosing quantity "Value"**

Parameter "Value" determines the dosing volume. The volume unit is specified in the "Unit" parameter.

The maximum size is limited to 9999.9 (one digit after the decimal point). The absolute quantity can be extended or restricted by a suitable choice of dosing unit.

### **Dosing unit "Unit"**

Parameter "Unit" defines the dosing volume unit. The choices are: mL, L, m3, galUS, galUK, barrel, user

### **Dosing correction value "Correction value"**

The "Correction value" parameter can be used to correct a system-related, constant "incorrect dosing" without having to change the actual dosing quantity. The correction value can be both positive and negative. If the system doses a smaller volume than intended, the correction value must be positive, but negative for a larger real volume. e.g.

Dosing quantity = 10 L

Correction value = -1 L

In this case, the metering counter will count from 10 L to '0', but will stop at 1 L because the quantity to be metered is 9 L calculated on the basis of the correction value of -1 L.

With a correction value of +1 L, the dosing counter will stop counting at -1 L, because the dosing amount is calculated to be 11 L.

$10 - (-1 \text{ L}) = 11 \text{ L}$

The adjustable value of the correction value must always be:

**(Value + Correction Value) > 0**

If this condition is not met, this will be indicated by a warning message and the correction value will be preset to the value - (Value-0.1).

### **Dosing parameter "Timeout"**

During the dosing process, the presence of a flow value not equal to 0 is constantly monitored. For this purpose, the parameter "Timeout" is used to set the time after which the status message "Time Out" is triggered.

The timeout value can be set between 0.5 sec and 10 sec.

Parameter table **Dosing**

Sublevel	Parameter level	Subparameter level 1	Subparameter level 2	Subparameter level 3	Description	Value range / value list	Standard value LPM version	Standard value GPM version
Activation	disabled				Dosing function deactivated		<i>disabled</i>	
	activated	Activation			Dosing function activated			
		Value	Value input			$0 \leq \text{Value} \leq 9999.99 [\text{unit}]$	0	
		Correction value	Value input			$-999.99 \leq \text{Value} \leq +999.99 [\text{unit}]$	0	
		Unit	List selection			<i>ml, L, m3, galUS, galUK, User</i>	L	<i>galUs</i>
Time out	Value input				0.5 - 10 sec	0.5 sec.		

### 13. IO-Link function

As of firmware version REV190320, the MIM flowmeter has an IO-Link communication interface as standard. Process and diagnostic data can be accessed directly via this interface and the device can be parameterized.

Output 1 is factory configured for IO-Link function. If the IO-Link communication mode is active, the "IOLINK" symbol in the status display for the outputs is displayed in green. The setup menu remains locked when the IOLINK mode is active and is inaccessible.

To ensure that the IO-Link device can be operated correctly on the connected IO-Link master, it is necessary to install the device description file matching the device.

The device description files (IODD) are available in the IODDfinder database under [ioddfinder.io-link.com](http://ioddfinder.io-link.com). There may be different IODD versions available for devices of the same type. To select the correct IODD, the device ID can either be read out via the connected IO-Link master or, alternatively, identification can be made using the device's firmware identifier.

The IODD assignment can be found in the following table.

Firmware ID	Product type	Device-ID [hex]	Device-ID [dec]	Remarks
V01.0_Rxxxxxx	-	-	-	No IO-Link function
V01.1_Rxxxxxx	MIM Compact up to 1 inch	0x010100	65792	-
	MIM Compact 2 inch	0x010200	66048	-
	MIM Remote up to 1 inch	0x010300	66304	-
	MIM Remote 2 inch	0x010400	66560	-
V01.11_Rxxxxxx	MIM Compact up to 1 inch	0x010600	67072	-
	MIM Compact 2 inch	0x010700	67328	-
	MIM Remote up to 1 inch	0x010800	67584	-
	MIM Remote 2 inch	0x010900	67840	-

How to download the correct IODD:

- Read out the firmware ID of the device from the INFO menu
- Find out the device ID (decimal) from the table above according to the firmware identification and the product type
- In the IODD finder, identify the correct IODD using the Device ID column and download the associated ZIP file using the download button.

If the device is operated on an IO-Link master with port class A, only a maximum output current of 50 mA may be drawn from output 2 (OUT2) (current or binary output), otherwise the IO-Link master will be overloaded and it can cause malfunctions.

## 13.1 Specification

Manufacturer	ID 1105 (decimal), 0x0451 (hex)
Manufacturer name	Kobold Messring GmbH
IO-Link specification	V1.1
Bitrate	COM3
Minimum cycle time	1.1 ms
SIO mode	yes (OUT1 in configuration IO-Link)
Block parameterisation	yes
Ready for operation	10 sec.
Max. cable length	20 m
IO-Link master port class	A



## 14. Technical Information

Measurement process:	electromagnetic
Range:	see order details
Media:	conductive fluids
Minimum conductivity:	≥20 μS/cm
Max. medium viscosity:	70 mm <sup>2</sup> /s
Max. pressure:	16 bar
Accuracy:	<±(0.8% of reading+0.5% of full scale)*
Repeatability:	±0.2% of full scale
Response time flow t <sub>90</sub>	
(alarm/pulse/frequency output):	<100 ms
(analogue output):	<1 s

### Temperature measurement

Sensor:	PT1000
Accuracy:	≤±2 °C (flow >0.2 m/s)
Measuring range:	temperature range of medium
Response time of temperature t <sub>90</sub>	
(signal output):	<20 s
Mounting position:	in all directions
In-/outlet:	3 x DN/2 x DN
Pressure drop (max at ME)	MB 05 400 mbar MB 10 50 mbar MB 15 250 mbar (¾"), 30 mbar (1") MB 20 80 mbar MB 40 450 mbar MB 35 120 mbar
Handling:	4 optical touch fields, useable with hand gloves**
Housing:	stainless steel 1.4404, display screen PMMA

### Wetted parts

Connection fitting and housing:	stainless steel 1.4404
Insulation parts:	PEEK
Electrodes:	stainless steel 1.4404
Seals:	FKM: MIM-12xxx; EPDM: MIM-13xxx
Protection:	IP 67

### Temperature ranges

Design	Electronic	Model	Seals material	Media temperature	Ambient temperature
compact version	C3T	MIM-12 MIM-13	FKM	-20 °C ... +70 °C	-20 °C ... +60 °C
			EPDM		
remote version (PVC cable)	P02 <sup>1)</sup>	MIM-12 MIM-13	FKM	-20 °C ... +85 °C	-20 °C ... +60 °C (display electronic)
			EPDM		-20 °C ... +85 °C (sensor)
remote version (ETFE cable)	E02 <sup>1)</sup>	MIM-12	FKM	-20 °C ... +140 °C	-20 °C ... +60 °C (display electronic)
			EPDM		-20 °C ... +140 °C (sensor)
		MIM-13	FKM	-40 °C ... +140 °C	-20 °C ... +60 °C (display electronic)
			EPDM		-40 °C ... +140 °C (sensor)

<sup>1)</sup> Cable length 02=2m, 05=5m, 10=10m, 15=15m, 20=20m

## Electrical data

Supply voltage:	19 - 30 VDC, internal power consumption max. 200 mA (without outputs)
Display:	TFT display, 128 x 128 pixels, 1.4" display orientation in 90° steps adjustable
Display repetition rate:	0.5 ... 10 s, adjustable
Pulse output	Push-Pull, freely scalable, configurable for partial or accumulated totalizer
Frequency output	Push-Pull, freely scalable, Overflow frequency adjustable
Alarm output:	NPN, PNP, Push-Pull, configurable max. 30 VDC, max. 200 mA short-circuit proof
Analogue output:	active, 3 wire, 0(4)-20 mA, max. load 500 Ω or 0-10 VDC, ( $R_i = 500 \Omega$ )
Control input (MIN / MAX / partial volume RESET)	OUT1, high active $0 < U_{Low} < 10 \text{ VDC}$ $15 \text{ VDC} < U_{High} < V_s$ No internal pull-ups available, active high / low signal necessary!
Total and partial quantity counter:	overflow (reset) at $15 * 10^6$ liters (regardless of the set unit)
Electrical connection:	plug M12x1, 4-pin
Dosing Function	
Dosing value:	0.1 ... 9999.9 [ <i>Unit</i> ]
Dosing output	OUT2 PushPull, High active
Control input:	OUT1, High active $0 < U_{Low} < 10 \text{ VDC}$ $15 \text{ VDC} < U_{High} < V_s$ No internal pull-ups available, active high / low signal necessary!
START/STOP pulse:	$0.5 \text{ s} < t_{high} < 4 \text{ s}$
RESET pulse:	$t_{high} > 5 \text{ s}$

\* Under reference conditions: media temperature: 15 °C ... 30 °C, 1 cSt, 500 µS/cm, 1 bar  
ambience temperature: 15 °C ... 30 °C

\*\* Limited functionally with black rubber gloves

Pressure Drop Curves [typical]

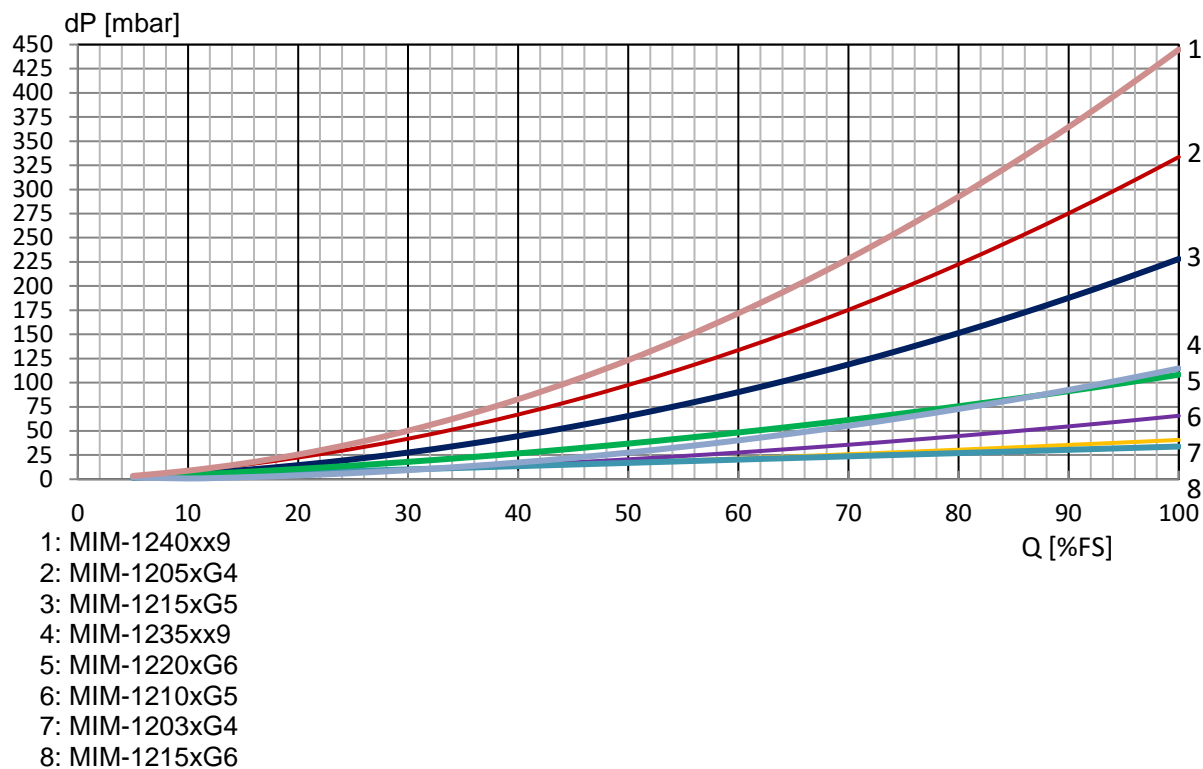

## 15. Order Codes



Order Details (Example: MIM-12 05G G4 C3T 0)

Model	Measuring Range <sup>1)</sup>	Native Connection	Electronics	Options
MIM-12.. = SS Housing SS Electrodes FKM Seals	..01G.. = 0.16...16 GPH ..01H.. = 0.01...1 LPM	..G2.. = G 1/4 Male	..C3T.. = Compact TFT Display 2x Configurable Outputs (Current/Voltage/Pulse/ Frequency/Alarm) M12x1 Electrical Connection	0 = Without K <sup>4)</sup> = Including Calibration Report
	..03G.. = 0.48...48 GPH ..03H.. = 0.03...3 LPM ..05G.. = 0.01...2.6 GPM ..05H.. = 0.04...10 LPM	..G4 <sup>3)</sup> .. = G 1/2 Male		
	..10G.. = 0.025...6.6 GPM ..10H.. = 0.1...25 LPM	..G5 <sup>3)</sup> .. = G 3/4 Male		
	..15G.. = 0.05...13 GPM ..15H.. = 0.2...50 LPM	..G6 <sup>3)</sup> .. = G 1 Male		
MIM-13.. = SS Housing SS Electrodes EPDM Seals	..20G.. = 0.1...26 GPM ..20H.. = 0.4...100 LPM	..N9.. = 2" NPT Female	..E02 <sup>2)</sup> .. = Remote Display Version, TFT Display, 2m ETFE Cable, Max. 284 °F	
	..35G.. = 0.4...90 GPM			
	..35H.. = 1.5...350 LPM			
<b>Accessories:</b> P/N 807.037 = 4-Pin Micro-DC Connector with 6-foot Cable P/N 807.037/5M = 4-Pin Micro-DC Connector with 16-foot Cable P/N 807.037/10M = 4-Pin Micro-DC Connector with 32-foot Cable				

<sup>1)</sup> Temperature units of measure factory programmed; °C for LPM models and °F for GPM/GPH models  
<sup>2)</sup> Order code substitution for longer cables: 020 = 2 m (6 ft), 050 = 5 m (16 ft), 100 = 10 m (32 ft), 150 = 15 m (49 ft), 200 = 20 m (65 ft).  
 Wall mounting brackets (brackets incl. accessories) are included in the scope of delivery.  
<sup>3)</sup> Regulation (EC) No. 1935/2004 for materials and articles intended to come in contact with food. Not for connection code G9/N9  
<sup>4)</sup> Please specify number of measuring points in clear text

### Accessories

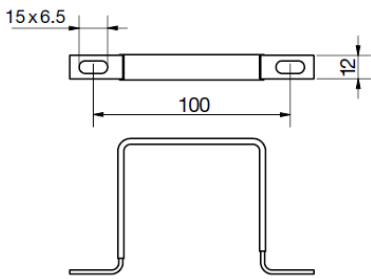
Description	Model	Image
Stainless steel wall mounting kit for remote version (2 brackets, without nuts/washers)	ERS-ZOK-023618	

Description	Model	Dimensions [mm]	Image
Clamping bracket set for wall mounting (stainless steel with partial polyolefin sleeve)	ZUB-MIM225128		

---

**Order Details MIM Fitting Sets Accessory Kits\***

Accessory kit number	Meter connection	Process connection	Fitting set type
ZUB-AD2U15P08	G ½ cap nut	¼" NPT male	Cap nut and union
ZUB-AD2G15P15	G ½ female	½" NPT male	Adapter
ZUB-AD2G15N08	G ½ female	¼" NPT female	Adapter
ZUB-AD2G15N15	G ½ female	½" NPT female	Adapter
ZUB-AD2U20P15	G ¾ cap nut	½" NPT male	Cap nut and union
ZUB-AD2G20P20	G ¾ female	¾" NPT male	Adapter
ZUB-AD2G20N15	G ¾ female	½" NPT female	Adapter
ZUB-AD2G20N20	G ¾ female	¾" NPT female	Adapter
ZUB-AD2U25P15	G 1 cap nut	½" NPT male	Cap nut and union
ZUB-AD2U25P20	G 1 female	¾" NPT male	Cap nut and union
ZUB-AD2G25N15	G 1 female	½" NPT female	Adapter
ZUB-AD2G25N20	G 1 female	¾" NPT female	Adapter

\* **Note:** All fitting kits include 2x Klinger SIL® flat sealing gaskets

16. Dimensions

[mm]  
Compact version

G
1/2
3/4
1

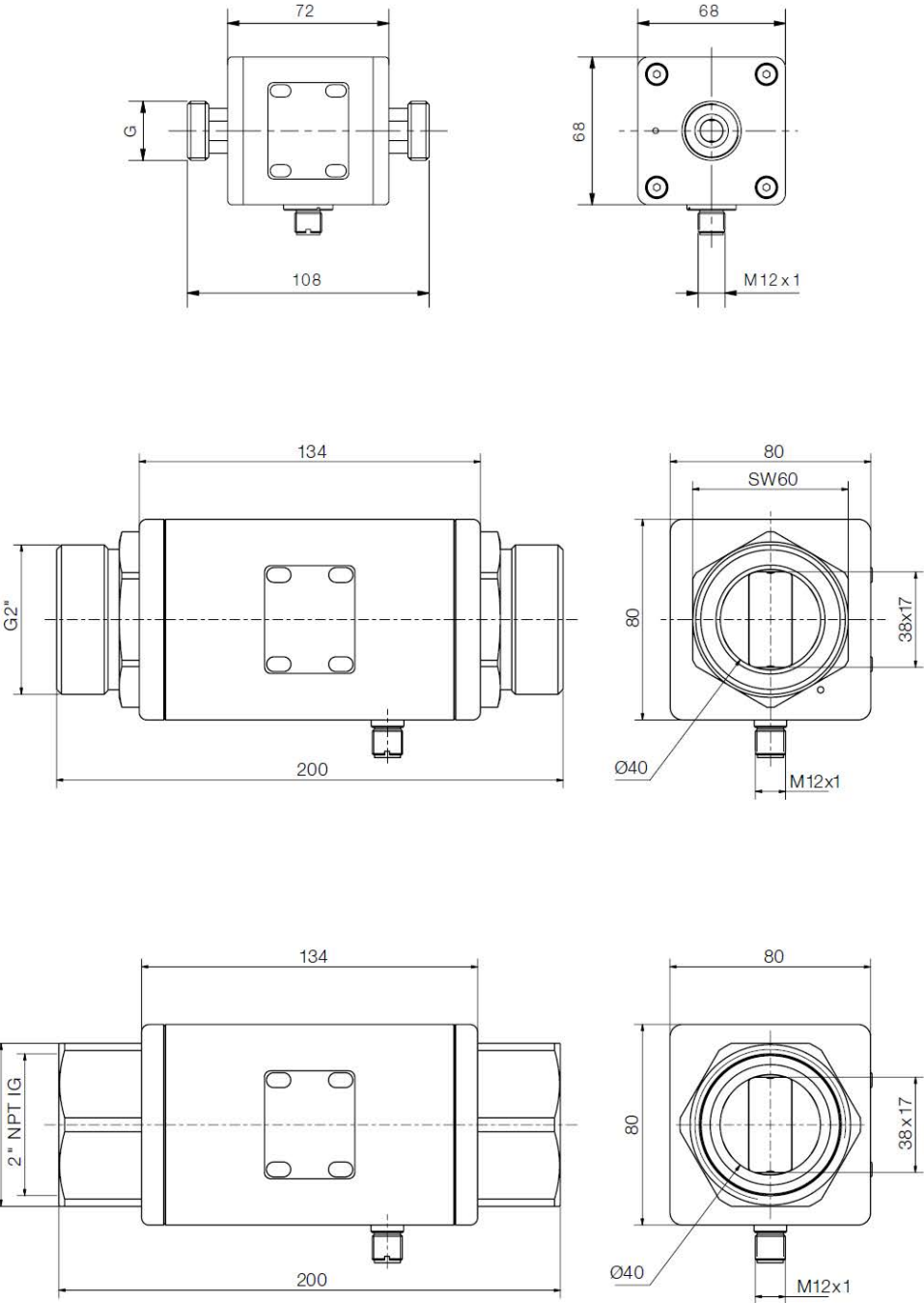

**Remote version  
Without wall mounting brackets**

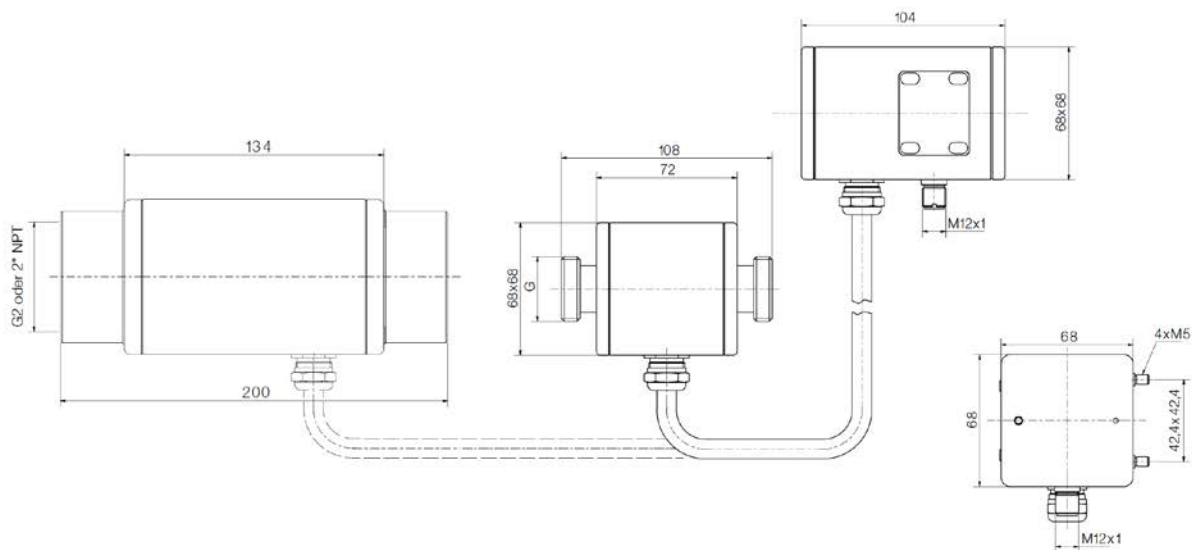

**With wall mounting brackets**

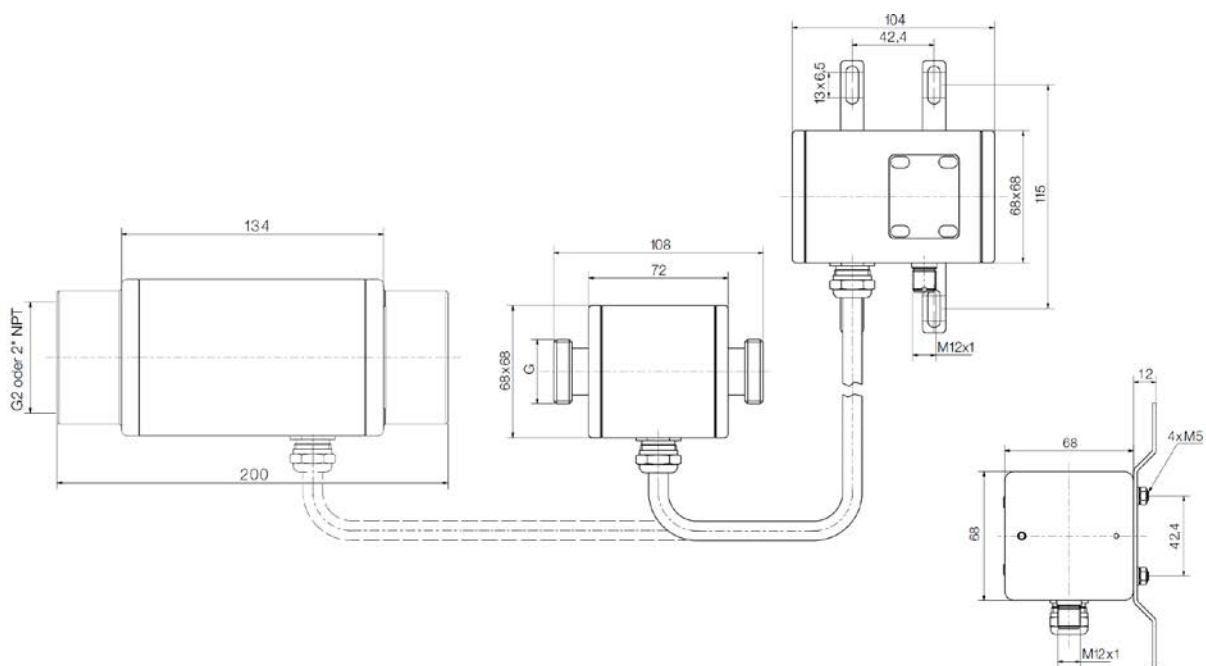

## 17. Appendix

### 17.1 IO-Link process data structure

Process data length: 9 bytes

Byte no.	Data	Bit count	Format	Factor	Range	Value
0 - 2	Flow	24 Bit	IntegerT	1/1000	+/-8388,608	L/min
3 - 6	Volume	32 Bit	FloatT		+/-1,4*10 <sup>-45</sup> ... +/-3,4*10 <sup>+38</sup>	L
7 - 8	Temperature	12 Bit	IntegerT	1/10	+/-204,8	°C
	reserved	1 Bit	BooleanT			
	reserved	1 Bit	BooleanT			
	Status OUT1	1 Bit	BooleanT			
	Status OUT2	1 Bit	BooleanT			

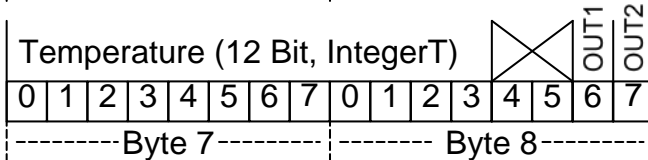
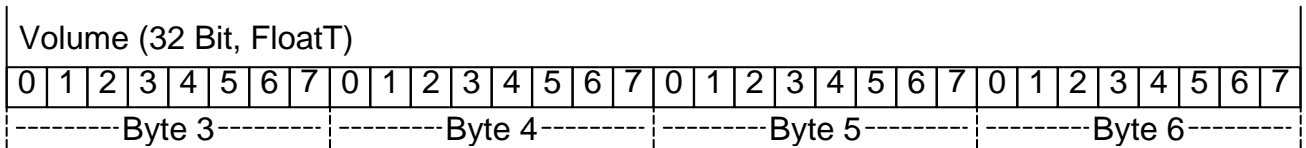
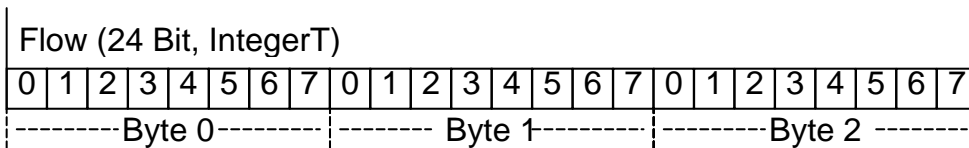



## 17.2 IO-Link diagnosis information

Event Code [hex]	Event Code [dec]	Name	Device Status	Type	Definition
0x7710	30480	Short Circuit		Error	check installation
0x8C10	35856	Process Variable Range Overrun		Warning	process data uncertain
0x8C20	35872	Measurement Range Overrun		Error	check application
0x8C30	35888	Process Variable Range Underrun		Warning	process data uncertain
0x1838	6200	1. Test Event For Protocol Testing		Error	first test event
0x1839	6201	2. Test Event For Protocol Testing		Error	second test event
0x183A	6202	Flow MRE Overrun		Warning	flow measuring range overrun
0x183B	6203	Flow MRS Underrun		Warning	flow measuring range underrun
0x183C	6204	Flow Overflow Overrun	2	Warning	flow overflow range overrun
0x183D	6205	Flow Underflow Underrun	2	Warning	flow underflow range underrun
0x183E	6206	Flow Cutoff Out		Warning	out of flow cutoff range
0x183F	6207	Temperature MRE Overrun		Warning	temperature measuring range overrun
0x1840	6208	Temperature MRS Underrun		Warning	temperature measuring range underrun
0x1841	6209	Temperature Overflow Overrun	2	Warning	temperature overflow range overrun
0x1842	6210	Temperature Underflow Underrun	2	Warning	temperature underflow range underrun
0x1843	6211	NVM Error	4	Error	non-volatile memory is corrupt
0x1844	6212	Subslave Lost		Error	communication to subs slave interrupted
0x1845	6213	Subslave Not Found	4	Error	communication to subs slave couldn't be established
0x1846	6214	Empty pipe		Warning	no media in tube
0x1847	6215	Temperature Sensor Error	4	Error	no sensor attached
0x1848	6216	Measuring Circuit Saturated	2	Warning	ADC out of range
0x1849	6217	Counter Overflow	2	Error	volume or part volume counter overflowed

Event Code [hex]	Event Code [dec]	Name	Device Status	Type	Definition
0x184A	6218	Dosing Timeout		Warning	indicates that the no flow timeout of the dosing function is active
0x184B	6219	Simulation Active		Warning	indicates that one of the simulations is running

### 17.3 IO-Link system command table

Command (hex)	Command (dec)	Command name
0x82	130	Restore factory settings
0xA0	160	Reset part volume counter
0xA1	161	Start flow simulation
0xA2	162	Stop flow simulation
0xA3	163	Start temperature simulation
0xA4	164	Stop temperature simulation
0xA5	165	Start part volume simulation
0xA6	166	Stop part volume simulation
0xA7	167	Events Handling ON
0xA8	168	Events Handling OFF
0xA9	169	Reset MinMax for Flow
0xAA	170	Reset MinMax for Temperature

## 17.4 IO Link ISDU parameter table

Parameters relating to the measured values flow, temperature or volume must be entered in the basic units and, if necessary, converted beforehand. The basic units are:

Flow: **L/min**

Temperature: **°C**

Volume: **liters**

### Units conversion table

Category: <b>Flow</b>		
Unit	description	conversion
L/m	Liters per minute (basic unit)	-
L/h	Liters per hour	1 L/h = 0.0167 L/m
mL/m	Milliliters per minute	1 mL/m = 0.001 L/m
m <sup>3</sup> /h	Cubic meters per hour	1 m <sup>3</sup> /h = 16.667 L/m
gal/m	US gallons per minute	1 gal/m = 3.7854 L/m
gal/h	US gallons per hour	1 gal/h = 0.06309 L/m
galk/m	UK gallons per minute	1 galk/m = 4.54609 L/m
galk/h	UK gallons per hour	1 galk/h = 0.07577 L/m
L/s	Liters per second	1 L/s = 60 L/m
mL/s	Milliliters per second	1 mL/s = 0.0000167 L/m
USER	user unit	1 user unit = USER * L/m

Category: <b>Temperature</b>		
Unit	description	conversion
°C	degree Celsius (basic unit)	-
°F	degree Fahrenheit	$x \text{ °C} = (32 + x * 1,8) \text{ °F}$
USER	user unit	1 user unit = USER * °C

Category: <b>Volume</b>		
Unit	description	conversion
L	Liters (basic unit)	-
mL	Milliliters	1 mL = 0.001 L
m <sup>3</sup>	Cubik meters	1 m <sup>3</sup> = 1000 L
galUS	US gallons	1 galUS = 3.7854 L
galUK	UK gallons	1 galk = 4.54609 L
barrel	Barrel (US)	1 barrel = 158.99 L
USER	user unit	1 user unit = USER * L

# MIM-

Index [hex]	Name	Description	Factory default	Max Value	Min Value	Length [Bytes]	Data Type	Access
<b>System</b>								
0x0002	SystemCommand	See Table "Comand Codes"				1	UIntegerT	W
<b>Product Identification (Vendor specific parameters)</b>								
0x0010	VendorName		Kobold Messring			max. 20	StringT	R
0x0011	VendorText		www.kobold.com			max. 32	StringT	R
0x0012	ProductName		MIM-XXXXXXXXXX			max. 16	StringT	R
0x0013	ProductID		[exact model code]			max. 16	StringT	R
0x0014	ProductText		magnetic inductive flow meter			max. 32	StringT	R
0x0015	Serialnumber	only read parameter				max. 8	StringT	R
0x0016	HardwareRevision					max. 8	StringT	R
0x0017	FirmwareRevision	Firmware Revision is constant in FW				max. 8	StringT	R
0x0018	ApplicationDevice Tag	tag name is from user configurable				32	StringT	R/W
0x0019	FunctionTag	function tag is from user configurable				32	StringT	R/W
0x0020	LocationTag	location tag is from user configurable				32	StringT	R/W

Index [hex]	Name	Description	Factory default	Max Value	Min Value	Length [Bytes]	Data Type	Access
<b>Device Status Information</b>								
0x0024	DeviceStatus	0 - Device OK 1 - Maintenance required 2 - Out of specification 3 - Functional check 4 - Failure				1	UIntegerT	R
0x0025	DetaildDevice Status					max. 20	ArrayT of OctetStringT 3	R
<b>Display Configuration</b>								
0x0100	DisplayOrientation	Orientation of display	1	(0) - Landscape (1) - Portrait Flip (2) - Landscape Flip (3) - Portrait		1	UIntegerT	R/W
0x0103	DisplayLayout	Single or dual layout	1	(0) - single (1) - dual		1	UIntegerT	R/W
0x0104	UpperDisplay	Source for the upper display	0	(0) - Flow (1) - Volume (2) - Temperature (3) - Part Volume		1	UIntegerT	R/W
0x0105	LowerDisplay	Source for the lower display	2	(0) - Flow (1) - Volume (2) - Temperature (3) - Part Volume		1	UIntegerT	R/W
0x0106	DisplayRefresh Time	Refresh intervall for the display [s]	0,5	10,0	0,5	4	FloatT	R/W
0x010A	LeftHotkey Function	Function for left hotkey	0	(0) - Off (1) - Value (2) - MinMax		1	UIntegerT	R/W
0x010B	RightHotkey Function	Function for right hotkey	0	(0) - Off (1) - Value (2) - MinMax		1	UIntegerT	R/W
0x010C	LeftHotkeySource	Source for the left hotkey	0	(0) - Flow (1) - Volume (2) - Temperature (3) - Part Volume		1	UIntegerT	R/W
0x010D	RightHotkeySource	Source for the right hotkey	0	(0) - Flow (1) - Volume (2) - Temperature (3) - Part Volume		1	UIntegerT	R/W
0x010E	SensitivityOptical Keys	Sensitivity for the optical keys	0	(0) - low (1) - middle (2) - high		1	UIntegerT	R/W
0x010F	AutomaticMenu Leave	Automatic menu leaves if the timeout [s] is hit. 0 = timeout not active	0	60	0	1	UIntegerT	R/W

Index [hex]	Name	Description	Factory default	Max Value	Min Value	Length [Bytes]	Data Type	Access
<b>Output 1 (In IO-Link mode output 1 can be parameterized individual, operating mode can only be changed manually)</b>								
0x0110	OUT1Source	Source for the output (production setting)	0	(0) - Flow (1) - Volume (2) - Temperature (3) - Part Volume		1	UIntegerT	
0x0111	OUT1Type	Configuration of the output: 0-20mA, Pulse, Frequency (production setting)	8	(0) - disabled (1) - Alarm Output (2) - 4-20mA (3) - 0-20mA (4) - 2-10V (5) - 0-10V (6) - Pulse Output (7) - Frequency Output (8) - M12COM (9) - IO-Link (10) - Control Input		1	UIntegerT	
0x0112	OUT1Alarm Function	Limit or window function for the alarm output	0	(0) - Limit (1) - Window		1	UIntegerT	R/W
0x0113	OUT1AlarmOutput Type	Alarm output NPN, PNP or Push pull	0	(0) - NPN (1) - PNP (2) - PushPull		1	UIntegerT	R/W
0x0114	OUT1AlarmSwitch Function	Alarm output normally opened or closed	0	(0) - normally opened (1) - normally closed		1	UIntegerT	R/W
0x0115	OUT1Alarm Threshold	Threshold for the alarm output [LPM/°C]	1,0	MRE	MRS	4	FloatT	R/W
0x0119	OUT1AlarmLower Threshold	Threshold for the alarm output used by the window function [LPM/°C]	1,0	OUT1Alarm Threshold	MRS	4	FloatT	R/W
0x011D	OUT1Alarm Hysteresis	Switching hysteresis for the alarm output [LPM/°C]	1,0	0	MBE - MBS	4	FloatT	R/W
0x0121	OUT1Alarm SuppressionFactor	How many times the threshold must be hit in order to switch the alarm output	0	60	0	1	UIntegerT	R/W
0x0122	OUT1Alarm Suppression Direction	for which direction the suppression factor is used	0	(0) - Up (1) - Down (2) - Both		1	UIntegerT	R/W

Index [hex]	Name	Description	Factory default	Max Value	Min Value	Length [Bytes]	Data Type	Access
0x0123	OUT1AnalogNamurStandard	If enabled (1) the analog output conforms with the NAMUR Standard NE42. If disabled (0) the analog output stays in his equivalent range (e.g. 4-20mA)	1	(0) - NAMUR disabled (1) - NAMUR enabled		1	UIntegerT	R/W
0x0124	OUT1AnalogValue0mA	The value from the slot used for the 0mA scaling point [LPM/°C]	0,0	OUT1AnalogValue20mA	MRS	4	FloatT	R/W
0x0128	OUT1AnalogValue4mA	The value from the slot used for the 4mA scaling point [LPM/°C]	0,0	OUT1AnalogValue20mA	MRS	4	FloatT	R/W
0x012C	OUT1AnalogValue20mA	The value from the slot used for the 20mA scaling point [LPM/°C]	100,0	MRE	OUT1AnalogValue0mA	4	FloatT	R/W
0x0130	OUT1AnalogValue0V	The value from the slot used for the 0V scaling point [LPM/°C]	0,0	OUT1AnalogValue10V	MRS	4	FloatT	R/W
0x0134	OUT1AnalogValue2V	The value from the slot used for the 2V scaling point [LPM/°C]	0,0	OUT1AnalogValue10V	MRS	4	FloatT	R/W
0x0138	OUT1AnalogValue10V	The value from the slot used for the 10V scaling point [LPM/°C]	100,0	MRE	OUT1AnalogValue0V	4	FloatT	R/W
0x013C	OUT1PulseVolume	The volume represented by one pulse [L]	1,0	999,999	0,000001	4	FloatT	R/W
0x0140	OUT1PulseVolumeUnit	Unit used for the pulse output	1	(0) - USER (1) - L (2) - mL (3) - m3 (4) - galUS (5) - galUK (6) - Barrel		1	UIntegerT	R/W
0x0141	OUT1PulseVolumeUnitUser	User Unit used for the pulse output [L]	1,0	9999,9	0,0	4	FloatT	R/W
0x0145	OUT1PulseWidth	Width of each pulse [ms]	1	20000	1	2	UIntegerT	R/W

Index [hex]	Name	Description	Factory default	Max Value	Min Value	Length [Bytes]	Data Type	Access
0x0147	OUT1FrequencyatFS	Max. frequency in Hz for the output [Hz]	500	1000	50	2	UIntegerT	R/W
0x0149	OUT1FrequencyOverflow	Overflow frequency in percent of the max frequency [%]	1	100	0	1	UIntegerT	R/W
0x014A	OUT1FrequencyValue0Hz	Value from source used for 0 Hz scaling point [LPM/°C]	0,0	OUT1 Frequency ValueMax Hz	MRS	4	FloatT	R/W
0x014E	OUT1FrequencyValueMaxHz	Value from source used for max. Hz scaling point [LPM/°C]	100,0	MRE	OUT1 Frequency Value0Hz	4	FloatT	R/W
0x0152	OUT1CtrlFunction	Control input function -> Off or Memory reset	0	(0) - Off (1) - Memoryreset		1	UIntegerT	R/W
<b>Output 2</b>								
0x0163	OUT2Source	Source for the output	0	(0) - Flow (1) - Volume (2) - Temperature (3) - Part Volume		1	UIntegerT	R/W
0x0164	OUT2Type	Configuration of the output -> 0-20mA, Pulse, Frequency, etc.	0	(0) - disabled (1) - Alarm Output (2) - 4-20mA (3) - 0-20mA (4) - 2-10V (5) - 0-10V (6) - Pulse Output (7) - Frequency Output		1	UIntegerT	R/W
0x0165	OUT2AlarmFunction	Limit or window function for the alarm output	0	(0) - Limit (1) - Window		1	UIntegerT	R/W
0x0166	OUT2AlarmOutputType	Alarm output NPN, PNP or Push pull	0	(0) - NPN (1) - PNP (2) - PushPull		1	UIntegerT	R/W
0x0167	OUT2AlarmSwitchFunction	Alarm output normally opened or closed	0	(0) - normally opened (1) - normally closed		1	UIntegerT	R/W
0x0168	OUT2AlarmThreshold	Threshold for the alarm output [LPM/°C]	1,0	MRE	MRS	4	FloatT	R/W
0x016C	OUT2AlarmLowerThreshold	Threshold for the alarm output used by the window function [LPM/°C]	1,0	OUT2AlarmThreshold	MRS	4	FloatT	R/W



Index [hex]	Name	Description	Factory default	Max Value	Min Value	Length [Bytes]	Data Type	Access
0x0170	OUT2Alarm Hysteresis	Switching hysteresis for the alarm output [LPM/°C]	1,0	0	MBE - MBS	4	FloatT	R/W
0x0174	OUT2Alarm SuppressionFactor	How many times the threshold must be hit in order to switch the alarm output	0	60	0	1	UIntegerT	R/W
0x0175	OUT2Alarm Suppression Direction	for which direction the suppression factor is used	0	(0) - Up (1) - Down (2) - Both		1	UIntegerT	R/W
0x0176	OUT2Analog NamurStandard	If enabled (1) the analog output conforms with the NAMUR Standard NE42. If disabled (0) the analog output stays in his equivalent range (e.g. 4-20mA)	1	(0) - NAMUR disabled (1) - NAMUR enabled		1	UIntegerT	R/W
0x0177	OUT2AnalogValue 0mA	The value from the slot used for the 0mA scaling point [LPM/°C]	0,0	OUT2 Analog Value20mA	MRS	4	FloatT	R/W
0x017B	OUT2AnalogValue 4mA	The value from the slot used for the 4mA scaling point [LPM/°C]	0,0	OUT2 Analog Value20mA	MRS	4	FloatT	R/W
0x017F	OUT2AnalogValue 20mA	The value from the slot used for the 20mA scaling point [LPM/°C]	100,0	MRE	OUT2Analog Value0mA	4	FloatT	R/W
0x0183	OUT2AnalogValue 0V	The value from the slot used for the 0V scaling point [LPM/°C]	0,0	OUT2 Analog Value10V	MRS	4	FloatT	R/W
0x0187	OUT2AnalogValue 2V	The value from the slot used for the 2V scaling point [LPM/°C]	0,0	OUT2 Analog Value10V	MRS	4	FloatT	R/W
0x018B	OUT2AnalogValue 10V	The value from the slot used for the 10V scaling point [LPM/°C]	100,0	MRE	OUT2Analog Value0V	4	FloatT	R/W

Index [hex]	Name	Description	Factory default	Max Value	Min Value	Length [Bytes]	Data Type	Access
0x018F	OUT2PulseVolume	The volume represented by one pulse [L]	1,0	999,999	0,000001	4	FloatT	R/W
0x0193	OUT2PulseVolume Unit	Unit used for the pulse output	1	(0) - USER (1) - L (2) - mL (3) - m3 (4) - galUS (5) - galUK (6) - Barrel		1	UIntegerT	R/W
0x0194	OUT2PulseVolume UnitUser	User Unit used for the pulse output [L]	1,0	9999,9	0,0	4	FloatT	R/W
0x0198	OUT2PulseWidth	The width of each pulse [ms]	1	20000	1	2	UIntegerT	R/W
0x019A	OUT2Frequencyat FS	The max. frequency in Hz for the output [Hz]	500	1000	50	2	UIntegerT	R/W
0x019C	OUT2Frequency Overflow	The overflow frequency in percent of the max frequency [%]	1	100	0	1	UIntegerT	R/W
0x019D	OUT2Frequency Value0Hz	The value from the slot used for the 0Hz scaling point [Hz]	0,0	OUT2FrequencyValue MaxHz	MRS	4	FloatT	R/W
0x01A1	OUT2Frequency ValueMaxHz	The value from the slot used for the max Hz scaling point [LPM/°C]	100,0	MRE	OUT2FrequencyValue0Hz	4	FloatT	R/W
<b>Dosing</b>								
0x01B6	DosingValue	Dosing value [L]	0,0	9999,9	0,0	4	FloatT	R/W
0x01BA	DosingCorrection Value	Correction value which is added to the dosing value for the complete dosing counter [L]	0,0	Dosing Value	minus Dosing Value	4	FloatT	R/W
0x01BE	DosingUnit	Unit used for the dosing function	1	(0) - USER (1) - L (2) - mL (3) - m3 (4) - galUS (5) - galUK (6) - Barrel		1	UIntegerT	R/W

Index [hex]	Name	Description	Factory default	Max Value	Min Value	Length [Bytes]	Data Type	Access
0x01BF	DosingUnitUser	User Unit used for the dosing function [L]	1,0	9999,9	0,0	4	FloatT	R/W
0x01C3	DosingTimeout	Timeout in seconds for no flow [s]	0,5	10,0	0,5	4	FloatT	R/W
0x01C7	DosingCounter	Saved dosing volume counter stats	0,0	999999,0	-999999,0	4	FloatT	R
<b>Service</b>								
0x01CB	ServiceUser Password	Password for user service menu and main menu	0	99999	0	4	UIntegerT	R/W
0x01CF	ServiceUserMenu Locked	Whether main menu is locked or not	0	(0) - not locked (1) - locked		1	UIntegerT	R/W
0x01D0	SimulationAuto Stop	Auto stop for Simulation after time [min]	10	31	1	1	UIntegerT	R/W

# MIM-

Index [hex]	Name	Description	Factory default	Max Value	Min Value	Length [Bytes]	Data Type	Access
<b>Misc</b>								
0x01D2	LanguageSelection	Language selection	0		(0) - English (1) - German (2) - French (3) - Spanish	1	UIntegerT	R/W
0x0262	OperatingHours Count	Operating hours counter [h]	0	4294967296	0	4	UIntegerT	R
<b>Flow</b>								
0x02F6	CutOff	Cut off for flow value [LPM]	0,0	MRE	0,0	4	FloatT	R/W
0x02FA	Unit	Unit used for flow	1		(0) - USER (1) - L/m (2) - mL/m (3) - L/h (4) - m3/h (5) - galUS/m (6) - galUS/h (7) - galUK/m (8) - galUK/h (9) - L/s (10) - mL/s	1	UIntegerT	R/W
0x02FB	UserUnit	User Unit used for flow [LPM]	1,0	9999,9	0,0	4	FloatT	R/W
0x0314	SimMode	Mode of the Simulation: Static, Triangle or Monotonic	0		(0) - Static (1) - Triangle (2) - Monotonic	1	UIntegerT	R/W
0x0315	SimStartValue	Value to start with the simulation [LPM]	0,0	9999,0	-9999,0	4	FloatT	R/W
0x0319	SimIncrement Value	Incrementation value of the simulation [LPM]	10,0	999,0	-999,0	4	FloatT	R/W
0x031D	SimNumber Intervals	Number of intervals to simulation	20	65000	1	2	UIntegerT	R/W
0x031F	SimTimingIntervals	Timing in ms between intervals	50	50000	50	2	UIntegerT	R/W
0x0321	ValueInSiUnit	Saved flow value in SI unit [LPM]	0,0	999999,0	-999999,0	4	FloatT	R
0x0325	MinValueInSiUnit	Saved min flow value in SI unit [LPM]	0,0	999999,0	-999999,0	4	FloatT	R

Index [hex]	Name	Description	Factory default	Max Value	Min Value	Length [Bytes]	Data Type	Access
0x0329	MaxValueInSiUnit	Saved max flow value in SI unit [LPM]	0,0	999999,0	-999999,0	4	FloatT	R
<b>Volume</b>								
0x0359	CountingType	counting type for a volume slot -> absolute or bidirectional	0	(0) - absolute (1) - bidirectional		1	UIntegerT	R/W
0x035E	Unit	Unit used for volume	1	(0) - USER (1) - L (2) - mL (3) - m3 (4) - galUS (5) - galUK (6) - Barrel		1	UIntegerT	R/W
0x035F	UserUnit	User Unit used for volume [L]	1,0	9999,9	0,0	4	FloatT	R/W
0x0385	ValueInSiUnit	Saved volume value in SI unit [L]	0,0	999999,0	-999999,0	4	FloatT	R
<b>Temperature</b>								
0x03C2	Unit	Unit used for temperature	1	(0) - USER (1) - °C (2) - °F		1	UIntegerT	R/W
0x03C3	UserUnit	User Unit used for temperature [°C]	1,0	9999,9	0,0	4	FloatT	R/W
0x03DC	SimMode	Mode of the Simulation: Static, Triangle or Monotonic	0	(0) - Static (1) - Triangle (2) - Monotonic		1	UIntegerT	R/W
0x03DD	SimStartValue	Value to start with the simulation [°C]	0,0	9999,0	-9999,0	4	FloatT	R/W
0x03E1	SimIncrement Value	Incrementation value of the simulation [°C]	10,0	999,0	-999,0	4	FloatT	R/W
0x03E5	SimNumber Intervals	Number of intervals to simulation	20	65000	1	2	UIntegerT	R/W
0x03E7	SimTimingIntervals	Timinig [ms] between intervals	50	50000	50	2	UIntegerT	R/W

# MIM-

Index [hex]	Name	Description	Factory default	Max Value	Min Value	Length [Bytes]	Data Type	Access
0x03E9	ValueInSiUnit	Saved temperature value in SI unit [°C]	0,0	999999,0	-999999,0	4	FloatT	R
0x03ED	MinValueInSiUnit	Saved min temperature value in SI unit [°C]	0,0	999999,0	-999999,0	4	FloatT	R
0x03F1	MaxValueInSiUnit	Saved max temperature value in SI unit [°C]	0,0	999999,0	-999999,0	4	FloatT	R
<b>Part Volume</b>								
0x0421	CountingType	counting type for a volume slot -> absolute or bidirectional	0	(0) - absolute (1) - bidirectional		1	UIntegerT	R/W
0x0426	Unit	Unit used for part volume	1	(0) - USER (1) - L (2) - mL (3) - m3 (4) - galUS (5) - galUK (6) - Barrel		1	UIntegerT	R/W
0x0427	UserUnit	User Unit used for part volume [L]	1,0	9999,9	0,0	4	FloatT	R/W
0x0440	SimMode	Mode of the Simulation: Static, Triangle or Monotonic	0	(0) - Static (1) - Triangle (2) - Monotonic		1	UIntegerT	R/W
0x0441	SimStartValue	Value to start with the simulation [L]	0,0	9999,0	-9999,0	4	FloatT	R/W
0x0445	SimIncrement Value	Incrementation value of the simulation [L]	10,0	999,0	-999,0	4	FloatT	R/W
0x0449	SimNumber Intervals	Number of intervals to simulation	20	65000	1	2	UIntegerT	R/W
0x044B	SimTimingIntervals	Timinig [ms] between intervals	50	50000	50	2	UIntegerT	R/W
0x044D	ValueInSiUnit	Saved part volume value in SI unit [L]	0,0	999999,0	-999999,0	4	FloatT	R

## Legend

MRE Measuring Range End

MRS Measuring Range Start

## 18. Manufacturer's declaration



### MANUFACTURER'S DECLARATION OF CONFORMITY



We:

**Kobold Messring GmbH**  
**Nordring 22-24**  
**65719 Hofheim**  
**Germany**

declare under our own responsibility that the product(s):

***MIM-1\*\*\*\*\* (IO-Link Device)***

to which this declaration refers conform to:

- IO-Link Interface and System Specification, V1.1, July 2013 (NOTE 1,2)
- IO Device Description, V1.1, August 2011
- IO-Link Interface and System Specification, V1.0, January 2009 (NOTE 1)
- IO Device Description, V1.0.1, March 2010

The conformity tests are documented in the test report:

***IO-Link\_Device\_TestReport\_MIM\_190301.pdf***

Issued at Hofheim, 01.03.2019

**Harald Peters**  
*General Manager*

**Manfred Wenzel**  
*Proxy Holder*

Reproduction and all distribution without written authorization prohibited

NOTE 1 Relevant Test specification is V1.1, July 2014

NOTE 2 Additional validity in Corrigendum Package 2015

## **19. EU Declaration of Conformance**

---

We, KOBOLD Messring GmbH, Hofheim-Ts, Germany, declare under our sole responsibility that the product:

**Electromagnetic Flowmeter**

**Model: MIM -1xxxxxxxxxx**

to which this declaration relates is in conformity with the standards noted below:

**EN 61326-1:2013** Electrical equipment for measurement, control and laboratory use - EMC requirements - Part 1: General requirements

**EN 60529:2014** Degrees of protection provided by enclosures (IP Code)

**EN 50581:2012** Technical documentation for the assessment of electrical and electronic products with respect to the restriction of hazardous substances

Also, the following EC guidelines are fulfilled:

**2014/30/EU**            **EMC Directive**

**2011/65/EU**            **RoHS** (category 9)

**2015/863/EU**            Delegated Directive (RoHS III)

Additional for MIM-13xxx:

**Regulation (EC) No 1935/2004** materials and articles intended to come into contact with food and repealing

**Regulation (EC) No. 2023/2006** good manufacturing practice for materials and articles intended to come into contact with food)



H. Peters  
General Manager



M. Wenzel  
Proxy Holder

Hofheim, 20 August 2020