

**Operating Instructions  
for  
Thermal Energy Flowmeter  
for gases**

**Model: KEC-1**



Order from: **C A Briggs Company**  
622 Mary Street; Suite 101; Warminster, PA 18974  
Phone: 267-673-8117 - Fax: 267-673-8118  
[Sales@cabriggs.com](mailto:Sales@cabriggs.com) - [www.cabriggs.com](http://www.cabriggs.com)

## **I. Foreword**

Dear customer,

thank you very much for deciding in favour of the KEC-1. Please read this installation and operation manual carefully before mounting and initiating the device and follow our advice. A riskless operation and a correct functioning of the KEC-1 are only guaranteed in case of careful observation of the described instructions and notes.

### **Manufactured and sold by:**

Kobold Messring GmbH  
Nordring 22-24  
D-65719 Hofheim  
Tel.: +49(0)6192-2990  
Fax: +49(0)6192-23398

## **II. Table of Content**

I.	Foreword .....	2
II.	Table of Content.....	3
1	Pictograms and Symbols .....	5
2	Signalwords according ISO 3864 and ANSI Z 535 .....	5
3	Safety instructions .....	6
3.1	Intended Use .....	7
3.2	Installation and commissioning.....	7
4	Technical data .....	8
4.1	Signal circuits.....	9
4.1.1	Modbus .....	9
4.1.2	Current output.....	9
4.1.2.1	Aktive .....	9
4.1.2.2	Passive .....	9
4.1.3	Pulse.....	9
4.1.4	Alarm .....	9
4.2	Measuring range flow KEC-1.....	10
4.2.1	Measuring range „Standard Version“ .....	11
4.2.2	Measuring range „Max Version“ .....	13
4.2.3	Measuring range „High Speed Version“ .....	15
5	Dimensions.....	17
5.1	Dimension KEC-1 .....	17
6	Installation .....	18
6.1	Pipe/tube requirements .....	18
6.2	Inlet / outlet runs .....	18
6.3	Installation KEC-1 .....	19
6.3.1	½“ welded nipple with ball valve ½“ .....	19
6.4	Installation of the Sensor .....	20
6.4.1	Mounting KEC-1 onto the ball valve .....	20
6.5	Alignment Display (Housing) .....	21
6.6	Tightening torques.....	21
7	Connection diagram .....	22
7.1	Cable glands - clamping ranges.....	22
7.2	Connector pin assignment.....	23
7.3	Wire connection .....	24
7.3.1	General: .....	24
7.3.2	Power supply .....	24
7.3.3	Modbus (termination):.....	24
7.3.4	Pulse Output.....	24
8	Operation KEC-1 .....	25
8.1	Main menu (Home).....	26

## Table of Content

---

8.1.1	Intialization.....	26
8.2	Main menu.....	26
8.3	Settings.....	27
8.3.1	Sensor Setup.....	28
8.3.1.1	Input / change tube diameter.....	28
8.3.1.2	Input / change consumption counter.....	29
8.3.1.3	Definition of the units for flow, velocity, temperature and pressure.....	29
8.3.1.4	Definition of the reference conditions.....	30
8.3.1.5	Setting of Zeropoint and Low-flow cut off.....	32
8.3.2	Modbus Setup.....	33
8.3.2.1	Modbus Settings (2001...2005).....	34
8.3.2.2	Values Register (1001 ...1500).....	34
8.3.3	Pulse /Alarm.....	36
8.3.3.1	Pulse output.....	36
8.3.4	User Setup.....	37
8.3.5	Advanced.....	38
8.3.6	4 -20mA.....	39
8.3.7	KEC-1 Info.....	41
8.4	MBus.....	41
8.4.1	Default Settings communication.....	41
8.4.2	Default values transmitted.....	41
9	Supplementary Documentation.....	42
10	EU Declaration of Conformance.....	43

## 1 Pictograms and Symbols



General Warning symbol (Danger, Warning, Caution)



General note



Installation- and Instruction manual to consider (on Nameplate)



Installation- and Instruction manual to consider

## 2 Signalwords according ISO 3864 and ANSI Z 535

- Danger!** Imminent danger  
As a consequence of incorrect handling: serious personal injury or death
- Warning!** Possible hazard  
As a consequence of incorrect handling: possible serious injury or death
- Caution!** Imminent hazard  
As a consequence of incorrect handling: possible personal injury or damage
- Note!** Possible hazard  
As a consequence of incorrect handling: possible personal injury or damage
- Important!** Additional notes, information, tips  
As a consequence of incorrect handling: Disadvantages in operation and maintenance, no danger

### 3 Safety instructions



**Please check whether this manual corresponds with the device type.**

Please attend to all notes indicated in this instruction manual. It contains essential information, which has to be followed during installation, operation and maintenance. Therefore this instruction manual has to be read categorically by the technician as well as by the responsible user/qualified personnel before installation, initiation and maintenance

Regional and national regulations respectively, have to be observed in addition to this instruction manual if necessary.

This instruction manual has to be available at any time at the operation site of the KEC-1.

Ensure that the KEC-1 operates within the permissible and listed limits on the nameplate. Otherwise there is a risk to human and material, and it may occur functional and operational disturbances

In case of any obscurities or questions with regard to this manual or the instrument please contact Kobold GmbH.



**Warning!**

**Risk of injury in case of inadequate qualification!**

Improper handling can result in significant personal injury and damage.

All activities described in this operating instructions manual must be carried out only by qualified personnel qualifications described below.

**Professionals (Technical staff)**

The technical staff is based on his education/training, his knowledge of measurement and control technology as well of the local regulations, standards and guidelines in the position to do the work as described and to identify the possible hazards.

Special working conditions require further appropriate knowledge, e.g. of aggressive media.



**Caution!**

**Malfunction of KEC-1**

Faulty installation and insufficient maintenance may lead to malfunctions of the KEC-1 which may affect the display and open to misinterpretation.



**Danger!**

**Inadmissible operating parameters!**

By exceeding or falling short of limits there is a risk for people and material, in addition there may occur further functional and operational disturbances.

**Measures:**

- Make sure that the KEC-1 operates only within the permissible and listed limits on the nameplate
- Ensure the operation within the performance data of KEC-1 in connection with the application
- Do not exceed the admissible storage and transportation temperature.

**Additional safety information:**

- When installing and operating the relevant national regulations and safety rules must also be observed.



When using the Flow-/ Consumption sensors KEC-1 Ex in gas hazardous areas the special requirements specified in the Ex documentation must be observed (in preparation).

### 3.1 Intended Use

The instrument described in this manual is exclusively to use for measuring the thermal mass flow of gases. At the same time, the gas temperature is measured too.

The KEC-1 can be configured for measuring a predetermined range of pure gases or of gas mixtures.

Consumption measurement of gases such as Air, oxygen, nitrogen, carbon dioxide, argon, etc. and with ATEX approval explosive gases such as natural gas, methane, propane and hydrogen.

Improper or incorrect use the operational reliability will be canceled. The manufacturer is not liable for any damage resulting by improper or incorrect use.

### 3.2 Installation and commissioning

- Installation, electrical installation, commissioning, operation and maintenance of the device must only be carried by qualified personnel, which were authorized by the plant operator. The personnel must read the operating instructions and understand and follow their instructions.
- If carrying out welding work on the pipeline the grounding of the welding unit is not allowed to be done over the KEC-1 itself.
- The installer has to ensure that the KEC-1 is connected according to the electrical connection diagrams properly. The sensor must be grounded, unless special protective measures have been taken (e.g. galvanically isolated power supply)
- The existing/ applicable national regulations governing opening and repair of the device have to be applied.
- When using the KEC-1 (ATEX Version) hazardous areas, in addition with the standard manual a separate Ex documentation is enclosed. The installation instructions and connection values indicated in these must also be observed (in preparation).
- The device fulfills the general safety requirements in accordance with EN 61010-1, the EMC requirements of IEC / EN 61326 and NAMUR recommendation NE 43.

## 4 Technical data

<b>Measures:</b>	mass flow, consumption flow speed, temperature
<b>Measuring principle:</b>	thermal mass flow sensor
<b>Medium temperature range:</b>	-40 ... 180 °C Probe (ATEX-Version -20 °C ... 120 °C) (in preparation)
<b>Operating temperature range:</b>	-20 ... 70 °C
<b>Operating pressure:</b>	50 bar
<b>Power supply:</b>	18 ... 36 VDC
<b>Power consumption:</b>	max. 5 W
<b>Output:</b>	Modbus RTU (acc. EIA/TIA-485 Standard) 2 x 4...20 mA active (optional passive) RL < 500 Ohm galvanically isolated pulse (Pulse weight freely selectable, Alarm max. 48 Vdc 0.5 A, optional: Modbus TCP, HART, ProfibusDP, Profi Net,
<b>Accuracy:</b> Standard version* (m.v. of meas. value) (f.s. of full scale)	± 1.5 % m.v. ± 0.3 % f.s.
<b>Accuracy:</b> Precision version* (m.v. of meas. value) (f.s. of full scale)	± 1.0 % m.v. ± 0.3 % f.s.
<b>Repeatability :</b>	0.25% m.v in case of correct mounting (mounting aid, position,inlet section
<b>Accuracy indications:</b>	referred to ambient temperature 22 °C +/-2 °C, system pressure 6 bar
<b>Response time:</b>	t90 < 3 s
<b>Display:</b>	2" TFT Color Display (320 x 240)
<b>Screw in thread:</b>	G 1/2" ISO 228, NPT 1/2", R 1/2", PT 1/2"
<b>Material:</b>	Housing aluminum die cast, probe stainless steel1,4571
<b>Protection class</b>	IP67

\* Reference conditions for Temperature and pressure can be freely set, standard conditions are 0 ° and 1013 mbar.



## 4.1 Signal circuits

### 4.1.1 Modbus

- According Standard EIA/TIA-485

### 4.1.2 Current output

#### 4.1.2.1 Aktive

- Galvanically isolated
- 4 ... 20 mA
- $R_L < 500 \text{ Ohm}$

#### 4.1.2.2 Passive

- Galvanically isolated
- 4 ... 20 mA
- $R_L < 500 \text{ Ohm}$
- $V_{in} 12\text{-}36 \text{ Vdc}$

### 4.1.3 Pulse

- Galvanically isolated (dry contact)
- Passive: 48 Vdc , 500 mA
- Max. pulse output freq. 50 Hz

### 4.1.4 Alarm

- Galvanically isolated
- Max. 48 Vdc, 500 mA

### 4.2 Measuring range flow KEC-1

The flow-/consumption sensor KEC-1 is available in 3 different versions:

- Standard max. measuring range of 92.7 m/s
- Max-Version max. measuring range of 185.0 m/s
- High speed-Version max. measuring range of 224 m/s

The sensors are programmed to pipe inner diameter of 53,1 mm this corresponds to analogue output 4- 20 mA of:

- Standard 0 ... 600 m<sup>3</sup>/h
- Max-Version 0 ... 1197.59 m<sup>3</sup>/h
- Highspeed-Version 0 ... 1450.06 m<sup>3</sup>/h

In case of use in other inner pipe diameter the diameter, using the display version, the diameter has to be set first.

For changing the inner pipe diameter and adjusting the 4...20 mA scaling, please refer to chapter "Operation".

The corresponding scale values for the respective version could be found in sections 4.2.1 to 4.2.3.

#### Example:

Pipe 1", Inner diameter 25mm

- Standard Version 0 ... 122.2 m<sup>3</sup>/h
- Max-Version Version 0 ... 1197.59 m<sup>3</sup>/h
- Highspeed-Version 0 ... 1450.06 m<sup>3</sup>/h

## Measuring range

### 4.2.1 Measuring range „Standard Version“

Innerdiameter of pipe		Standard Version (92,7 m/s)								Recommended Sensor length
		Full scale value in in Nm <sup>3</sup> /h								
Inch	mm	Air <sup>2)</sup>	Air <sup>3)</sup>	Ar <sup>3)</sup>	CO <sub>2</sub> <sup>3)</sup>	N <sub>2</sub> <sup>3)</sup>	O <sub>2</sub> <sup>3)</sup>	N <sub>2</sub> O <sup>3)</sup>	Methane <sup>3)</sup> Natural gas <sup>3)</sup>	160 mm
1/2"	<b>16.1</b>	45.6	41.9	71.3	45.1	40.5	43.5	44.7	26.9	
3/4"	<b>21.7</b>	89.1	81.9	139.3	88.1	79.2	85.0	87.4	52.7	
<b>1"</b>	<b>25.0</b>	<b>122.2</b>	112.3	191.0	120.9	108.6	116.5	119.8	72.2	
	<b>26.0</b>	132.9	122.1	207.7	131.5	118.1	126.7	130.3	78.6	
	<b>27.3</b>	147.5	135.7	230.8	146.1	131.3	140.8	144.8	87.3	
	<b>28.5</b>	162.0	148.9	253.2	160.3	144.0	154.5	158.9	95.8	
	<b>30.0</b>	180.9	166.3	282.8	179.0	160.8	172.5	177.4	107.0	
1 1/4"	<b>32.8</b>	218.8	201.1	342.0	216.5	194.5	208.7	214.6	129.4	
	<b>36.0</b>	266.3	244.8	416.3	263.4	236.7	254.0	261.1	157.4	
	<b>36.3</b>	270.7	249.2	423.8	268.2	241.0	258.5	265.9	160.3	
1 1/2"	<b>39.3</b>	320.1	294.7	501.2	317.2	285.0	305.7	314.4	189.5	
	<b>40.0</b>	332.5	305.7	519.8	329.0	295.6	317.1	326.1	196.6	
	<b>41.9</b>	366.7	335.5	570.5	361.1	324.4	348.1	357.9	215.8	
	<b>43.1</b>	389.4	358.0	608.8	385.3	346.2	371.4	381.9	230.3	
	<b>45.8</b>	441.9	406.3	691.0	437.3	392.9	421.5	433.5	261.3	
2"	<b>50.0</b>	530.6	487.8	829.6	525.0	471.8	506.1	520.5	313.8	
	<b>51.2</b>	557.1	512.1	871.0	551.2	495.3	531.4	546.4	329.4	
	<b>53.1</b>	600.0	551.5	938.0	593.6	533.4	572.3	588.4	354.7	
	<b>54.5</b>	632.8	581.7	989.3	626.1	562.6	603.6	620.6	374.2	
	<b>57.5</b>	707.8	685.9	1166.6	738.3	663.4	711.7	731.8	441.2	
	<b>60.0</b>	773.6	711.1	1209.4	765.4	687.8	737.8	758.7	457.4	
	<b>64.2</b>	888.9	817.2	1389.7	879.5	790.3	847.8	871.8	525.6	

<sup>2)</sup> Referred to DIN 1945 / ISO 1217 (20°C, 1000 mbar) and compressed air.

<sup>3)</sup> Referred to DIN 1343: 0°C, 1013.25 mbar

## Measuring range

Innerradius of pipe		Standard Version (92,7 m/s)								Recommended Sensor length
		Full scale value in in Nm <sup>3</sup> /h								
Inch	mm	Air <sup>2)</sup>	Air <sup>3)</sup>	Ar <sup>3)</sup>	CO <sub>2</sub> <sup>3)</sup>	N <sub>2</sub> <sup>3)</sup>	O <sub>2</sub> <sup>3)</sup>	N <sub>2</sub> O <sup>3)</sup>	Methane <sup>3)</sup> Natural gas <sup>3)</sup>	
2 1/2"	<b>65.0</b>	913.5	838.7	1426.3	902.6	811.1	870.2	894.8	539.4	
	<b>70.3</b>	1071	984.6	1674.5	1059.7	952.2	1021.6	1050.4	633.3	
	<b>71.1</b>	1095	1007.1	1712.8	1083.9	974.0	1044.9	1074.5	647.8	
	<b>76.1</b>	1258	1156.5	1966.9	1244.8	1118.5	1200.0	1233.9	743.9	
3"	<b>80.0</b>	1390	1279.6	2176.3	1377.3	1237.6	1327.7	1365.3	823.1	
	<b>82.5</b>	1480	1362.5	2317.2	1466.5	1317.7	1413.7	1453.7	876.4	
	<b>84.9</b>	1569	1442.9	2454.0	1553.0	1395.5	1497.1	1539.5	928.1	
	<b>90.0</b>	1766	1623.5	2761.0	1747.3	1570.1	1684.4	1732.1	1044.2	
4"	<b>100.0</b>	2183	2006.7	3412.8	2159.8	1940.7	2082.0	2140.9	1290.7	
	<b>107.1</b>	2507	2304.5	3919.3	2480.3	2228.8	2391.1	2458.7	1482.2	
	<b>110.0</b>	2644	2431.0	4134.4	2616.5	2351.1	2522.3	2593.6	1563.6	
5"	<b>125.0</b>	3423	3143.0	5345.2	3382.7	3039.7	3261.0	3353.2	2021.5	
	<b>133.7</b>	3921	3595.7	6115.2	3870.0	3477.5	3730.7	3836.2	2312.7	
6"	<b>150.0</b>	4941	4531.3	7706.4	4877.0	4382.4	4701.5	4834.4	2914.5	
	<b>159.3</b>	5579	5110.6	8691.6	5500.5	4942.6	5302.5	5452.5	3287.1	
	<b>182.5</b>	7323	6715.6	11421.2	7227.9	6494.9	6967.8	7164.9	4319.4	
	<b>190.0</b>	7947	7278.9	12379.2	7834.2	7039.7	7552.3	7765.8	4681.7	
8"	<b>200.0</b>	8816	8074.9	13733.0	8690.9	7809.5	8378.2	8615.1	5193.7	
	<b>206.5</b>	9398	8608.3	14640.1	9265.0	8325.4	8931.6	9184.2	5536.8	
10"	<b>250.0</b>	13742	12632.1	21483.4	13595.8	12216.9	13106.5	13477.2	8124.8	
	<b>260.4</b>	14945	13721.2	23335.8	14768.0	13270.3	14236.6	14639.2	8825.4	
12"	<b>300.0</b>	19836	18211.8	30972.9	19601.2	17613.3	18895.9	19430.2	11713.7	
	<b>309.7</b>	21139	19408.6	33008.2	20889.3	18770.7	20137.5	20707.0	12483.5	
	<b>339.6</b>	25418	23337.1	39689.5	25117.5	22570.1	24213.6	24898.4	15010.2	
	<b>388.8</b>	33317	32376.6	55063.0	34846.6	31312.6	33592.6	34542.6	20824.4	
	<b>500.0</b>	55101	50588.4	86036.0	54447.9	48925.9	52488.5	53972.9	32538.1	
	<b>600.0</b>	79345	72847.4	123891.8	78405.0	70453.3	75583.4	77720.9	46854.9	
	<b>700.0</b>	107998	99153.3	168630.5	106717.9	95894.8	102877.4	105786.8	63774.7	
	<b>800.0</b>	141058	129506.4	220252.1	139386.6	125250.3	134370.5	138170.6	83297.5	
	<b>900.0</b>	178527	163906.5	278756.5	176411.1	158519.9	170062.7	174872.1	105423.5	
	<b>1000.0</b>	220404	202353.8	344143.9	217791.5	195703.6	209953.9	215891.5	130152.4	

<sup>2)</sup> Referred to DIN 1945 / ISO 1217 (20°C, 1000mbar) and compressed air.

<sup>3)</sup> Referred to DIN 1343: 0°C, 1013,25 mbar

## Measuring range

### 4.2.2 Measuring range „Max Version“

Innerdiameter of pipe		Max Version (185,0 m/s)								Recommended Sensor length
		Full scale value in in Nm <sup>3</sup> /h								
Inch	mm	Air <sup>2)</sup>	Air <sup>3)</sup>	Ar <sup>3)</sup>	CO <sub>2</sub> <sup>3)</sup>	N <sub>2</sub> <sup>3)</sup>	O <sub>2</sub> <sup>3)</sup>	N <sub>2</sub> O <sup>3)</sup>	Methane <sup>3)</sup> Natural gas <sup>3)</sup>	160 mm
1/2"	<b>16.1</b>	90.98	83.7	142.2	90.0	80.9	86.7	89.2	53.8	
3/4"	<b>21.7</b>	177.84	163.5	278.0	176.0	158.1	169.6	174.4	105.2	
<b>1"</b>	<b>25.0</b>	243.88	224.2	381.2	241.4	216.9	232.5	239.1	144.2	
	<b>26.0</b>	265.20	243.8	414.6	262.5	235.8	252.9	260.0	156.8	
	<b>27.3</b>	294.72	271.0	460.7	291.7	262.1	281.0	289.0	174.3	
	<b>28.5</b>	323.32	297.3	505.4	320.0	287.5	308.3	317.0	191.2	
	<b>30.0</b>	361.08	332.0	564.5	357.4	321.1	344.3	354.1	213.5	
1 1/4"	<b>32.8</b>	436.69	401.5	682.7	432.2	388.3	416.4	428.2	258.2	
	<b>36.0</b>	531.48	488.7	830.8	526.0	472.6	506.8	521.1	314.3	
	<b>36.3</b>	541.06	497.5	845.8	535.5	481.1	515.9	530.5	320.0	
1 1/2"	<b>39.3</b>	639.84	588.3	1000.2	633.3	568.9	610.1	627.4	378.4	
	<b>40.0</b>	663.68	610.2	1037.5	656.9	590.1	632.8	650.8	392.5	
	<b>41.9</b>	728.41	669.7	1138.7	720.9	647.7	694.5	714.2	430.7	
	<b>43.1</b>	777.34	714.7	1215.2	769.4	691.2	741.2	762.2	459.7	
	<b>45.8</b>	882.17	811.1	1379.0	873.1	784.4	841.2	865.0	521.7	
2"	<b>50.0</b>	1059.23	973.9	1655.8	1048.3	941.9	1010.0	1038.6	626.4	
	<b>51.2</b>	1112.05	1022.5	1738.4	1100.6	988.8	1060.4	1090.4	657.6	
	<b>53.1</b>	1197.59	1101.1	1872.1	1185.3	1064.9	1141.9	1174.3	708.2	
	<b>54.5</b>	1263.13	1161.4	1974.6	1250.2	1123.2	1204.4	1238.5	747.0	
	<b>57.5</b>	1489.43	1369.5	2328.3	1474.1	1324.4	1420.2	1460.5	880.8	
	<b>60.0</b>	1544.12	1419.8	2413.8	1528.3	1373.0	1472.3	1514.1	913.1	
	<b>64.2</b>	1774.33	1631.4	2773.7	1756.1	1577.7	1691.8	1739.8	1049.3	

<sup>2)</sup> Referred to DIN 1945 / ISO 1217 (20°C, 1000mbar) and compressed air.

<sup>3)</sup> Referred to DIN 1343: 0°C, 1013.25 mbar

## Measuring range

Innerdiameter of pipe		Max Version (185,0 m/s)								Recommended Sensor lenght
		Full scale value in in Nm <sup>3</sup> /h								
Inch	mm	Air <sup>2)</sup>	Air <sup>3)</sup>	Ar <sup>3)</sup>	CO <sub>2</sub> <sup>3)</sup>	N <sub>2</sub> <sup>3)</sup>	O <sub>2</sub> <sup>3)</sup>	N <sub>2</sub> O <sup>3)</sup>	Methane <sup>3)</sup> Natural gas <sup>3)</sup>	
2 1/2"	<b>65.0</b>	1821.03	1674.4	2846.7	1802.3	1619.2	1736.4	1785.6	1076.9	
	<b>70.3</b>	2137.86	1965.7	3342.0	2115.9	1901.0	2038.5	2096.3	1264.2	
	<b>71.1</b>	2186.80	2010.7	3418.5	2164.3	1944.5	2085.1	2144.2	1293.2	
	<b>76.1</b>	2511.24	2309.0	3925.7	2485.4	2233.0	2394.5	2462.4	1485.0	
3"	<b>80.0</b>	2778.58	2554.8	4343.6	2750.0	2470.7	2649.4	2724.5	1643.1	
	<b>82.5</b>	2958.51	2720.2	4624.9	2928.1	2630.7	2821.0	2900.9	1749.5	
	<b>84.9</b>	3133.15	2880.8	4897.9	3101.0	2786.0	2987.5	3072.2	1852.8	
4"	<b>90.0</b>	3525.11	3241.2	5510.6	3488.9	3134.5	3361.2	3456.5	2084.6	
	<b>100.0</b>	4357.22	4006.3	6811.4	4312.5	3874.4	4154.7	4272.4	2576.6	
	<b>107.1</b>	5003.91	4600.9	7822.3	4952.5	4449.4	4771.3	4906.5	2959.1	
5"	<b>110.0</b>	5278.56	4853.4	8251.7	5224.3	4693.6	5033.2	5175.8	3121.5	
	<b>125.0</b>	6824.50	6274.8	10668.3	6754.4	6068.3	6507.2	6691.7	4035.7	
	<b>133.7</b>	7807.53	7178.7	12205.1	7727.3	6942.4	7444.6	7655.6	4617.0	
6"	<b>150.0</b>	9839.04	9046.6	15380.8	9738.0	8748.8	9381.7	9647.6	5818.3	300 mm
	<b>159.3</b>	11096.91	10203.2	17347.2	10982.9	9867.2	10581.1	10881.0	6562.2	
	<b>182.5</b>	14581.94	13407.5	22795.1	14432.2	12966.1	13904.1	14298.2	8623.0	
	<b>190.0</b>	15805.08	14532.1	24707.2	15642.8	14053.7	15070.4	15497.5	9346.4	
8"	<b>200.0</b>	17533.48	16121.3	27409.1	17353.4	15590.6	16718.4	17192.3	10368.4	
	<b>206.5</b>	18691.68	17186.2	29219.6	18499.7	16620.4	17822.8	18327.9	11053.3	
10"	<b>250.0</b>	27428.75	25219.6	42877.8	27147.1	24389.4	26153.7	26895.0	16220.0	
	<b>260.4</b>	29793.76	27394.2	46574.9	29487.8	26492.3	28408.8	29214.0	17618.6	
12"	<b>300.0</b>	39544.48	36359.5	61817.6	39138.4	35162.5	37706.2	38775.0	23384.7	
	<b>309.7</b>	42143.03	38748.8	65879.8	41710.2	37473.1	40184.0	41323.0	24921.3	
400 mm	<b>339.6</b>	50673.25	46592.0	79214.6	50152.8	45058.1	48317.6	49687.2	29965.7	
	<b>388.8</b>	70301.30	64639.2	109898.0	69579.3	62511.2	67033.2	68933.3	41572.8	
	<b>500.0</b>	109845.79	100998.7	171715.7	108717.6	97673.7	104739.4	107708.2	64957.5	
	<b>600.0</b>	158177.93	145438.2	247270.6	156553.4	140650.1	150824.8	155099.9	93538.7	
	<b>700.0</b>	215297.74	197957.5	336562.7	213086.6	191440.4	205289.3	211108.2	127316.6	
	<b>800.0</b>	281205.22	258556.8	439592.2	278317.2	250044.6	268133.0	275733.1	166291.1	
	<b>900.0</b>	355900.35	327235.9	556358.8	352245.2	316462.7	339355.8	348974.7	210462.2	
	<b>1000.0</b>	439383.15	403995.0	686862.7	434870.6	390694.7	418957.8	430833.0	259829.8	

<sup>2)</sup> Referred to DIN 1945 / ISO 1217 (20°C, 1000mbar) and compressed air.

<sup>3)</sup> Referred to DIN 1343: 0°C, 1013,25 mbar

## Measuring range

### 4.2.3 Measuring range „High Speed Version“

Innerdiameter of pipe		High Speed Version (224,0 m/s)								Recommended Sensor length
		Full scale value in in Nm <sup>3</sup> /h								
Inch	mm	Air <sup>2)</sup>	Air <sup>3)</sup>	Ar <sup>3)</sup>	CO <sub>2</sub> <sup>3)</sup>	N <sub>2</sub> <sup>3)</sup>	O <sub>2</sub> <sup>3)</sup>	N <sub>2</sub> O <sup>3)</sup>	Methane <sup>3)</sup> Natural gas <sup>3)</sup>	160 mm
1/2"	<b>16.1</b>	110.16	101.3	172.2	109.0	98.0	105.0	108.0	65.2	
3/4"	<b>21.7</b>	215.33	198.0	336.6	213.0	191.5	205.3	211.2	127.4	
<b>1"</b>	<b>25.0</b>	295.30	271.6	461.7	292.1	262.6	281.6	289.6	174.7	
	<b>26.0</b>	321.11	295.3	502.0	317.7	285.6	306.2	314.9	189.9	
	<b>27.3</b>	356.85	328.2	557.9	353.0	317.3	340.3	350.0	211.1	
	<b>28.5</b>	391.48	360.0	612.0	387.3	348.1	373.3	384.0	231.6	
	<b>30.0</b>	437.20	402.1	683.5	432.5	388.8	416.9	428.8	258.6	
1 1/4"	<b>32.8</b>	528.75	486.3	826.6	523.1	470.2	504.2	518.6	312.8	
	<b>36.0</b>	643.52	591.8	1006.1	636.6	572.3	613.6	631.2	380.7	
	<b>36.3</b>	655.12	602.5	1024.2	648.1	582.6	624.7	642.5	387.5	
1 1/2"	<b>39.3</b>	774.73	712.5	1211.2	766.4	689.0	738.8	759.9	458.3	
	<b>40.0</b>	803.59	739.0	1256.3	795.0	714.6	766.3	788.2	475.3	
	<b>41.9</b>	881.96	811.1	1378.9	872.5	784.3	841.0	865.0	521.7	
	<b>43.1</b>	941.21	865.6	1471.5	931.1	837.0	897.5	923.1	556.7	
	<b>45.8</b>	1068.14	982.3	1669.9	1056.7	949.9	1018.5	1047.6	631.8	
2"	<b>50.0</b>	1282.52	1179.5	2005.1	1268.8	1140.5	1223.0	1257.9	758.6	
	<b>51.2</b>	1346.48	1238.3	2105.1	1332.1	1197.4	1284.0	1320.6	796.5	
	<b>53.1</b>	1450.06	1333.5	2267.0	1434.5	1289.5	1382.7	1422.2	857.7	
	<b>54.5</b>	1529.41	1406.5	2391.1	1513.0	1360.1	1458.4	1500.1	904.7	
	<b>57.5</b>	1803.42	1658.5	2819.5	1784.1	1603.8	1719.7	1768.8	1066.8	
	<b>60.0</b>	1869.63	1719.4	2923.0	1849.6	1662.6	1782.8	1833.7	1105.9	
	<b>64.2</b>	2148.38	1975.7	3358.8	2125.4	1910.5	2048.6	2107.1	1270.8	

<sup>2)</sup> Referred to DIN 1945 / ISO 1217 (20°C, 1000mbar) and compressed air.

<sup>3)</sup> Referred to DIN 1343: 0°C, 1013,25 mbar

## Measuring range

Innerdiameter of pipe		High Speed Version (224,0 m/s)								Recommended Sensor length
		Full scale value in in Nm <sup>3</sup> /h								
Inch	mm	Air <sup>2)</sup>	Air <sup>3)</sup>	Ar <sup>3)</sup>	CO <sub>2</sub> <sup>3)</sup>	N <sub>2</sub> <sup>3)</sup>	O <sub>2</sub> <sup>3)</sup>	N <sub>2</sub> O <sup>3)</sup>	Methane <sup>3)</sup> Natural gas <sup>3)</sup>	
2 1/2"	<b>65,0</b>	2204,93	2027,7	3447,2	2181,3	1960,8	2102,6	2162,6	1304,3	220 mm
	<b>70,3</b>	2588,55	2380,5	4046,9	2560,8	2302,0	2468,4	2538,9	1531,2	
	<b>71,1</b>	2647,80	2435,0	4139,6	2619,4	2354,7	2524,9	2597,0	1566,2	
	<b>76,1</b>	3040,63	2796,3	4753,7	3008,1	2704,0	2899,5	2982,3	1798,6	
3"	<b>80,0</b>	3364,33	3094,0	5259,8	3328,3	2991,8	3208,1	3299,7	1990,1	
	<b>82,5</b>	3582,20	3294,3	5600,4	3543,8	3185,6	3415,9	3513,4	2118,9	
	<b>84,9</b>	3793,65	3488,8	5931,0	3753,0	3373,6	3617,5	3720,8	2244,0	
	<b>90,0</b>	4268,24	3925,3	6672,9	4222,5	3795,7	4070,1	4186,3	2524,7	
4"	<b>100,0</b>	5275,76	4851,8	8248,1	5219,2	4691,7	5030,8	5174,5	3120,7	
	<b>107,1</b>	6058,78	5571,9	9472,3	5993,9	5388,0	5777,5	5942,5	3583,9	
	<b>110,0</b>	6391,34	5877,7	9992,2	6322,9	5683,7	6094,6	6268,6	3780,6	
	<b>125,0</b>	8263,17	7599,2	12918,6	8174,6	7348,3	7879,5	8104,6	4887,8	
5"	<b>133,7</b>	9453,44	8693,8	14779,4	9352,1	8406,8	9014,5	9272,0	5591,9	
	<b>150,0</b>	11913,22	10955,9	18625,0	11785,6	10594,3	11360,1	11684,5	7046,9	
	<b>159,3</b>	13436,25	12356,6	21006,1	13292,3	11948,7	12812,4	13178,3	7947,8	
	<b>182,5</b>	17655,97	16237,2	27603,2	17466,8	15701,2	16836,2	17317,0	10443,8	
6"	<b>190,0</b>	19136,96	17599,2	29918,6	18931,9	17018,2	18248,5	18769,6	11319,9	
	<b>200,0</b>	21229,73	19523,8	33190,4	21002,3	18879,3	20244,1	20822,2	12557,8	
	<b>206,5</b>	22632,08	20813,4	35382,8	22389,6	20126,4	21581,3	22197,6	13387,3	
	<b>250,0</b>	33211,03	30542,3	51921,9	32855,2	29534,1	31669,1	32573,5	19644,9	
8"	<b>260,4</b>	36074,61	33175,8	56398,8	35688,1	32080,6	34399,7	35382,1	21338,8	
	<b>300,0</b>	47880,89	44033,3	74856,6	47367,9	42579,8	45657,8	46961,7	28322,4	
	<b>309,7</b>	51027,24	46926,8	79775,6	50480,5	45377,8	48658,1	50047,7	30183,5	
	<b>339,6</b>	61355,72	56425,3	95923,1	60698,3	54562,8	58507,1	60177,9	36293,0	
10"	<b>388,8</b>	85121,58	78281,5	133078,5	84209,6	75697,4	81169,5	83487,5	50350,9	
	<b>500,0</b>	133002,47	122314,8	207935,1	131577,4	118277,2	126827,4	130449,3	78673,3	
	<b>600,0</b>	191523,55	176133,3	299426,6	189471,5	170319,2	182631,4	187847,0	113289,6	
	<b>700,0</b>	260684,83	239736,9	407552,8	257891,8	231823,3	248581,6	255680,6	154199,7	
12"	<b>800,0</b>	340486,31	313125,8	532313,9	336838,2	302789,6	324678,0	333950,2	201403,7	
	<b>900,0</b>	430927,99	396299,8	673709,7	426310,9	383218,1	410920,6	422655,7	254901,6	
	<b>1000,0</b>	532009,87	489259,1	831740,4	526309,8	473108,8	507309,4	521797,2	314693,3	

<sup>2)</sup> Referred to DIN 1945 / ISO 1217 (20°C, 1000mbar) and compressed air.

<sup>3)</sup> Referred to DIN 1343: 0°C, 1013,25 mbar



5 Dimensions

5.1 Dimension KEC-1

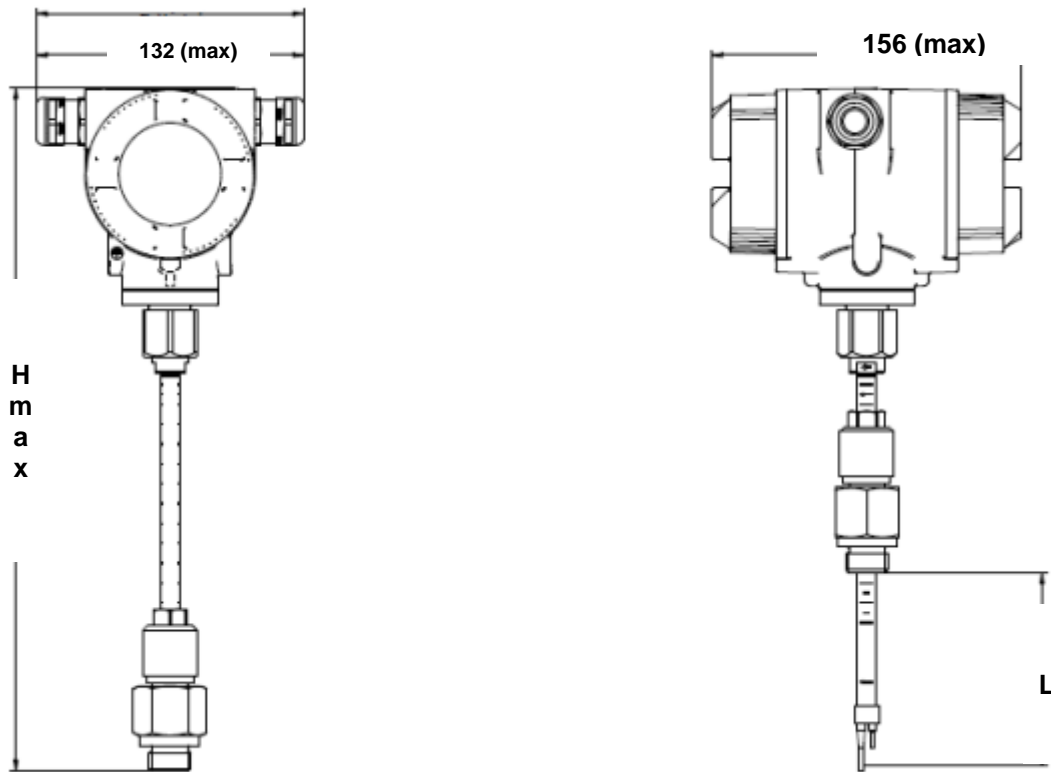

Sensor lenght	L [mm]	H [mm]
C1	220	441
C2	300	521
C3	400	621
C4	500	721
C5	600	821
C7	160	381

## 6 Installation

### 6.1 Pipe/tube requirements

- Correctly sized gaskets
- Correct aligned flanges and gaskets
- Diameter mismatch at the pipe junctions should be avoided but must be less than 1mm. For further information see ISO 14511
- Ensure clean pipes after installation

### 6.2 Inlet / outlet runs

The principle of thermal Mass flow measurement is very sensitive against disturbances. Therefore, it is necessary to ensure the recommended inlet and outlet runs.

Table Inlet / Outlet runs

Flow obstruction before the measurement section	Min length Inlet run (L1)	Min length Outlet run (L2)
Slight curve (ellbow < 90°)	12 x D	5 x D
Reduction (Pipe narrows to the measurement section)	15 x D	5 x D
Expansion (Pipe expands to the measurement section)	15 x D	5 x D
90° ellbow or T-piece	15 x D	5 x D
2x ellbow á 90° in einer Ebene	20 x D	5 x D
2x ellbow á 90° 3-dimensional	35 x D	5 x D
Control valve	45 x D	5 x D

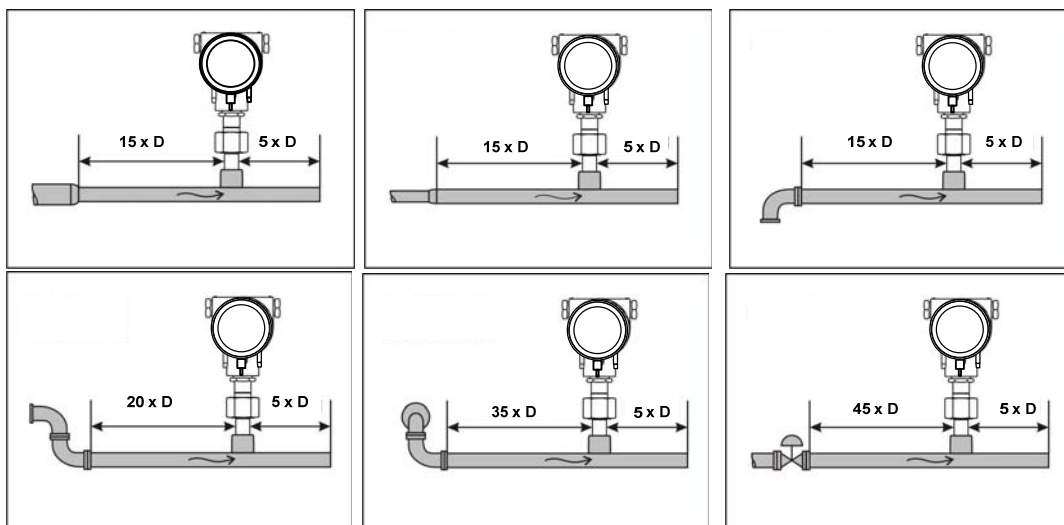

The values represent the min.lengths. In case the min. inlet / outlet runs could not be ensured, it must be expected to get increased or significant deviations of the measurement values.

### 6.3 Installation KEC-1

The installation of the sensor is done via a ball valve 1/2 ".

If no valid measuring point with a ball valve 1/2 " is available there are following ways to set up a measuring point.

#### 6.3.1 1/2" welded nipple with ball valve 1/2"



**Important:**

Ensure that the system is in shut down, ie.depressurized.

**Note for installation with ball valve**

Ball valve R 1/2", DN 15

Passage ball valve: Minimum Ø15 mm

## 6.4 Installation of the Sensor

### 6.4.1 Mounting KEC-1 onto the ball valve

- Assembly is carried out by inserting the connection thread with gasket. (G1/2" thread, SW 32) into the connection piece (ball valve). The sensor has be tighten by hand as far as possible and then tighten with stipulated torque of 25-30 Nm. It must be ensured that the installation is pressure-tight.



- The sensor is then inserted to the required immersion depth and aligned according to the direction of the airflow. A depth scale engraved on the probe tube, a flow alignment arrow and an aligning device will be of help for you. Once the sensor has been aligned the adapter sleeve must be tighten with stipulated torque of 20-30Nm (SW 17).

**Attention:** Alignment of the sensor must not be modified when tightening the connection thread and adapter sleeve. In this case, please check the immersion depth and alignment again and correct it if necessary. The angular deviation should not be greater than  $\pm 2^\circ$  in relation to ideal position as otherwise the measuring accuracy will decrease.

Calculation mounting depth:

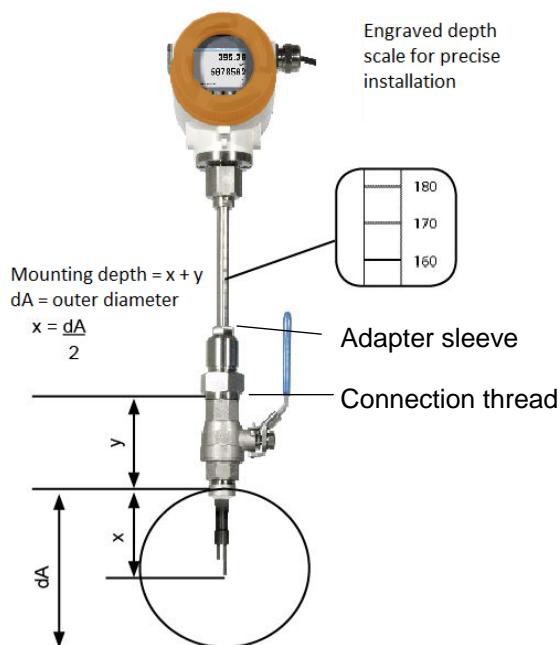

Alignment



### 6.5 Alignment Display (Housing)

The sensor housing KEC-1 can be turned in both directions, max. 345 °. For this purpose, the housing-connecting nut must be opened. The housing can be rotated to the desired position, a bigger rotation angle is prevented by internal stop pins.

After that, the housing-connecting nut is firmly retighten

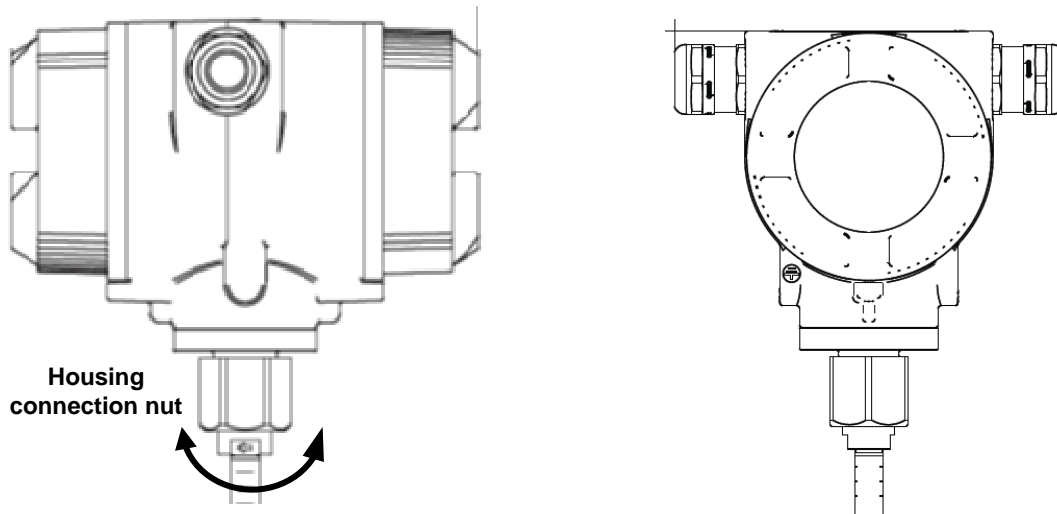

### 6.6 Tightening torques

To secure and guarantee of the function and tightness following tightening torques have to be applied, see table 1.

Table 1

Pos	Description	Tightening torque [Nm]
20	KEC-1 cover with glass	3
30	KEC-1 cover without window	3
50	Grub screw with hexagon socket M4x6 DIN 914 A2	2
130	KEC-1 nut	15
150	Cylinder screw DIN 6912 - M5x10 A2-70	4

## 7 Connection diagram

### 7.1 Cable glands - clamping ranges

For ensuring the tightness and strain relief, connector cables with the following diameters must be used.

KEC-1 Standard clamping range : Ø 5- 9mm

KEC-1 Ex clamping range : Ø 5-10mm (in preparation)

7.2 Connector pin assignment

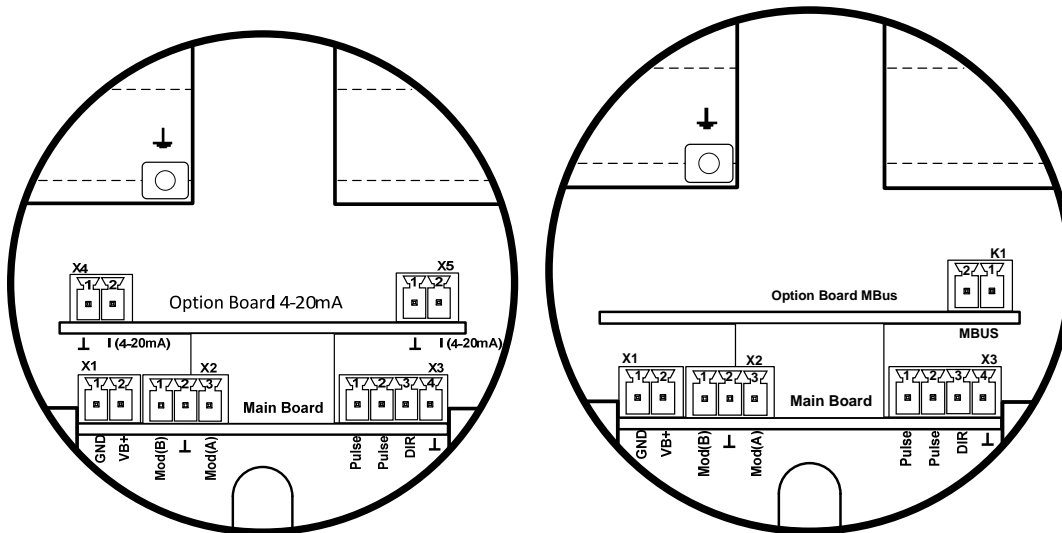

Connector	Pin	Signal description
<b>X1</b> Power supply	1	VB - (GND)
	2	VB+ (12V – 36 Vdc)
<b>X2</b> Modbus	1	Modbus (B)
	2	Modbus shield
	3	Modbus (A)
<b>X3</b> Analogue output	1	Pulse / Alarm *
	2	Pulse / Alarm *
	3	Direction input
	4	GND
<b>X4</b> Current output 1	1	I- Aktiv*
	2	I+ Aktiv*
<b>X5</b> Current output 2	1	I- Aktiv*
	2	I+ Aktiv*
<b>K1</b> MBus	1	MBus
	2	MBus

\* All analogue outputs are galvanically isolated.

\*\* The analogue outputs are optional as passive output available too.

7.3 Wire connection

7.3.1 General:

- Wiring to be done in strainless state only.
- Length of cable skinning to be minimized
- Not used cable entries must be closed with end caps
- Use of cables with cross section of  $\geq 0.25\text{mm}^2$

7.3.2 Power supply

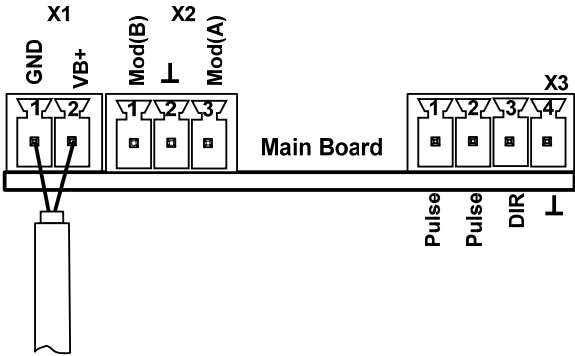

7.3.3 Modbus (termination):

If the sensor placed at the end of the Modbus system a termination is required. Therefore the enclosed 120R resistor is to be connected at Pin 1 and Pin 3 of connector „X2“

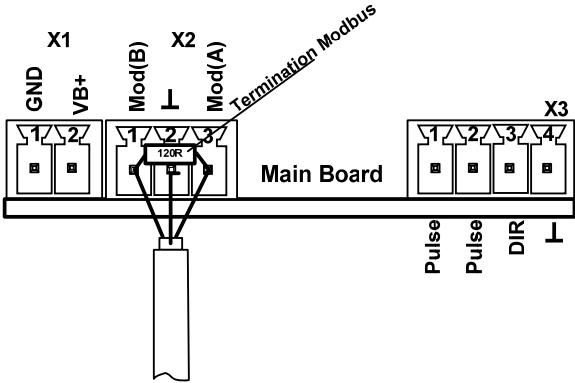

7.3.4 Pulse Output

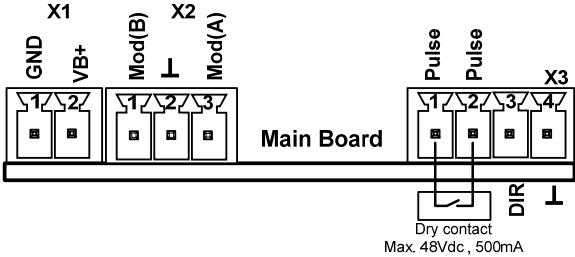



## 8 Operation KEC-1

The operation of the KEC-1 is carried out by 2 optical keys through the glass cover. Thus, the KEC-1 can be operated from the outside without opening the cap.

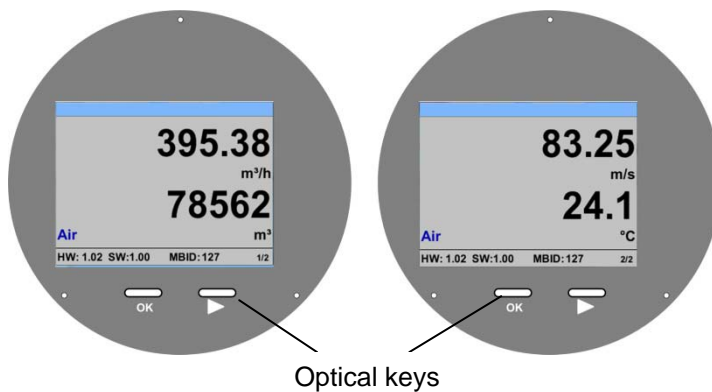

Selection of the individual menu items is done by pressing the ">" and confirm by pressing "OK".

Inputs or changes can be made with all white deposit fields, selected field will be highlighted with yellow background.

Words in **green font** refer mainly to the pictures in the section of the chapter, but also on important menu paths or menu items that are related to are in **green font**.

The menu navigation is generally in a **green font**!

The table of contents and chapter references in **blue font** contain links to the respective chapter title.

## 8.1 Main menu (Home)

### 8.1.1 Initialization

After switching on the KEC-1 the initialized screen is displayed followed by the main menu.

## 8.2 Main menu

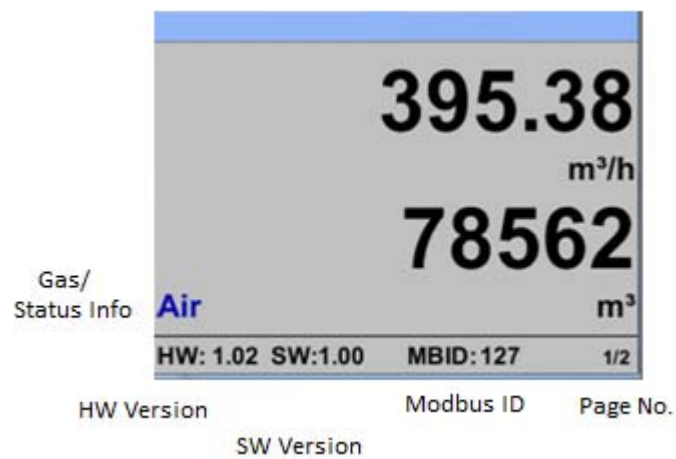

Switching to pages 2-4 or back by pressing key „△“

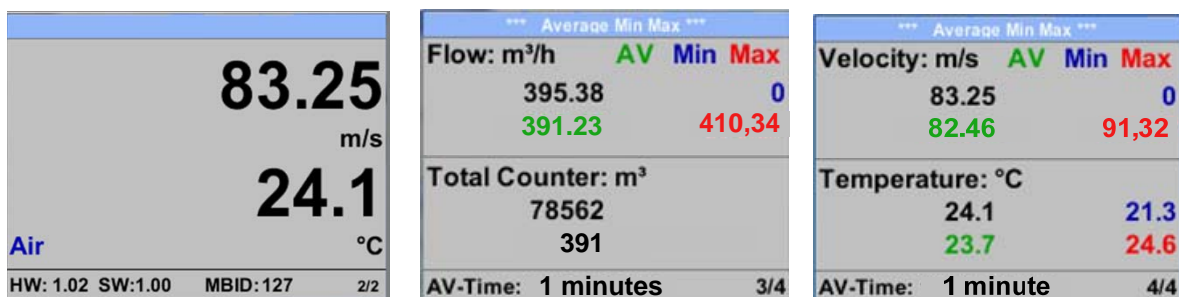

AV-Time ( Period for average value calculation) could be changed under *Sensor Setup.-Advanced- AV-Time*

### 8.3 Settings

The settings menu could accessed by pressing the key „OK“.

But the access to the *settings menu* is password protected.



Factory settings for password at the time of delivery: 0000 (4 times zero).

If required the password could be changed at *Setup–User setup–Password*.

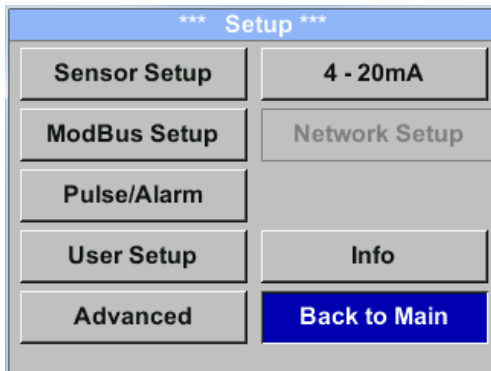

Selection of a menu item or to change a value is done with the key „ $\Delta$ “, a final move to the chosen menu item or takeover of the value change needs the confirmation by pressing the key „OK“

### 8.3.1 Sensor Setup

Setup → Sensor Setup

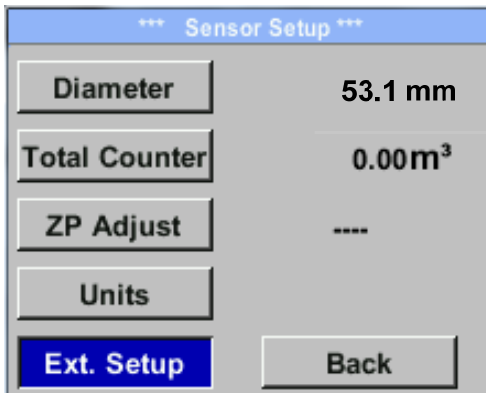

For changes, first select the menu item with key „Δ“ and then confirm it with **“OK”**.

#### 8.3.1.1 Input / change tube diameter

Settings → Sensor Setup → Diameter

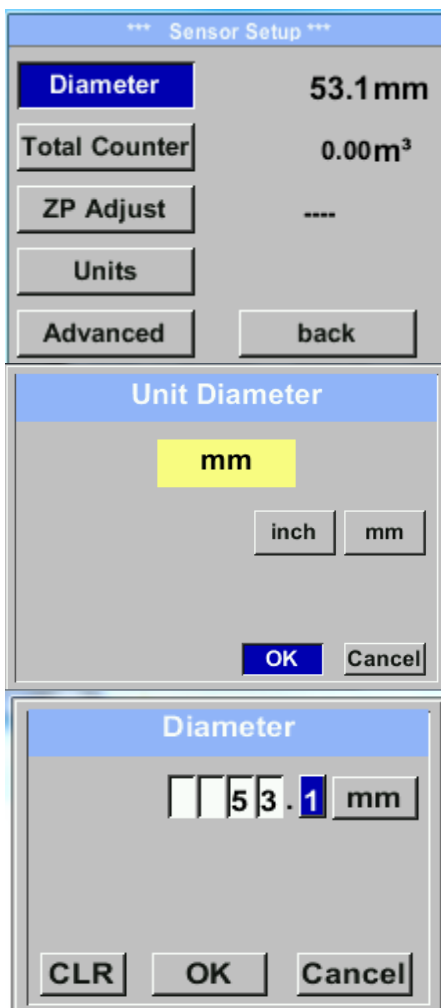

In order to change, e.g. the unit, first select by pressing key „Δ“ the field **“Units”** and then key **“OK”**.

Select with the key „Δ“ the correct unit and then confirm selection by pressing 2x **„OK”**.

Entering / changing the diameter via button „Δ“, select the respective position and activate the position with the **“OK”** button.

By pressing „Δ“ the position value is incremented by 1. Complete with **“OK”** and activate next number position. Confirm entry by pressing **„OK”**.

8.3.1.2 Input / change consumption counter

Setup → Sensor Setup → Total Counter → Unit button

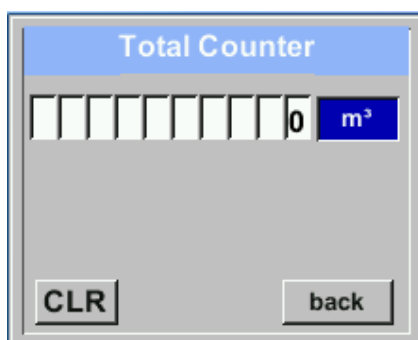
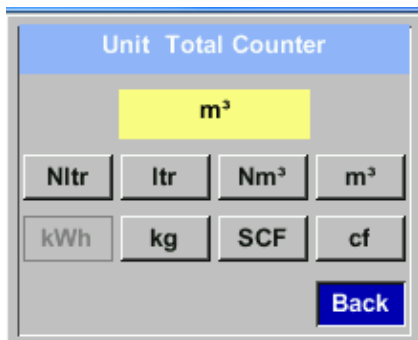

In order to change, e.g. the unit, first select by pressing key „Δ“ the button **“Unit”** and then key **“OK”**.

Select with the key „Δ“ the correct unit and then confirm selection by pressing 2x **„OK”**.

Entering / changing the consumption counter via button „Δ“, select the respective position and activate the position with the **“OK”** button.

By pressing „Δ“ the position value is incremented by 1. Complete with **“OK”** and activate next number position.

Confirm entry by pressing **„OK”**.

**Important!**

When the counter reach 10000000 m<sup>3</sup> the counter will be reset to zero.

8.3.1.3 Definition of the units for flow, velocity, temperature and pressure

Setup → Sensor Setup → Units

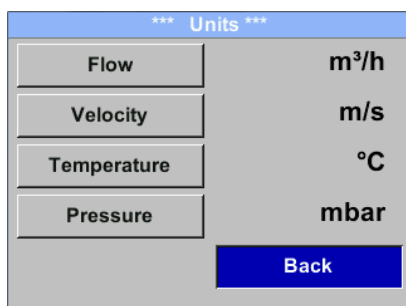

To make changes to the unit for the respective measurement value, first select by pressing „Δ“ the field of the „measurement value“ and activate „it with **„OK”**.

Selection of the new unit with „Δ“

In case the quantity of units selectable are not presentable on one page, please move to next page by pressing **„<<”**.

Confirm selection by pressing 2x **„OK”**.

Procedure for all 4 measurement-variables is analogous.

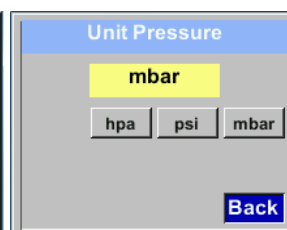
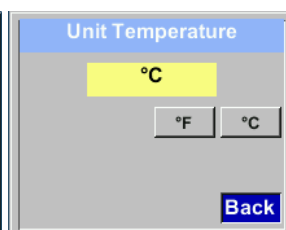
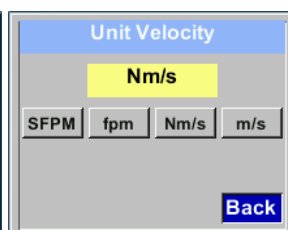
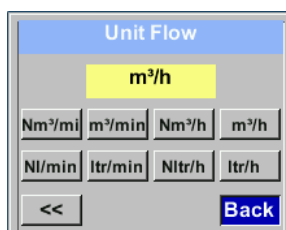

### 8.3.1.4 Definition of the reference conditions

Here can be defined the desired measured media reference conditions for pressure and temperature and times for the filter and averaging.

- Factory pre-setting for reference temperature and reference pressure are 20 °C, 1000 hPa
- All volume flow values (m³/h) and consumption values indicated in the display are related to 20 °C and 1000 hPa (according to ISO 1217 intake condition)
- Alternatively 0 °C and 1013 hPa (=standard cubic meter) can also be entered as a reference.
- **Do not enter the operation pressure or the operation temperature under reference conditions!**

Setup → Sensor Setup → Advanced

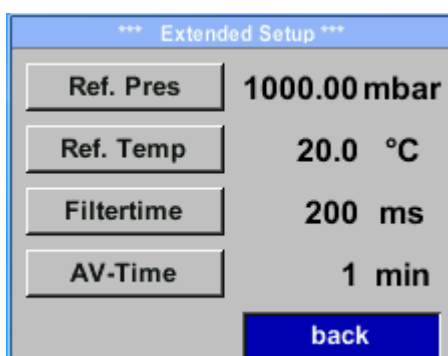

To make changes, first select a menu with button „Δ“ and confirm selection by pressing „OK“.

Setup → Sensor Setup → Advanced → Ref.Pref



In order to change, e.g. the unit, first select by pressing key „Δ“ the field **“Units”** and then key **“OK”**.

Select with the key „Δ“ the correct unit and then confirm selection by pressing 2x **„OK”**.

Input / change of the value by selecting the respective position with button „Δ“ and entering by pressing button **„OK”**.

Setup → Sensor Setup → Advanced → Ref.Temp

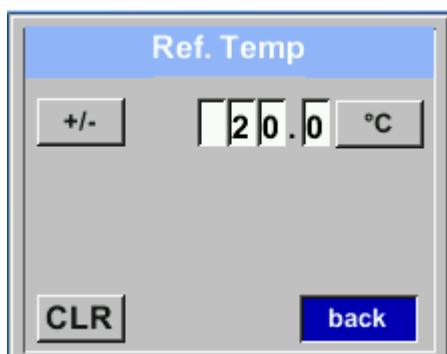

By pressing „Δ“ the position value is incremented by 1. Complete with **“OK”** and activate next number position.

Procedure for changing the reference temperature is the same.

Setup → Sensor Setup → Advanced → *Filtertime*

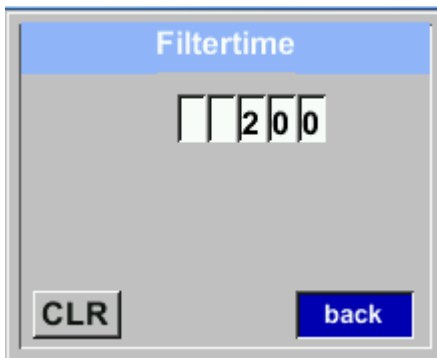

Under item "*Filtertime*" an attenuation can be defined.  
Input values of 0 -10000 in [ms] are possible

Setup → Sensor Setup → Advanced → *AV-Time*

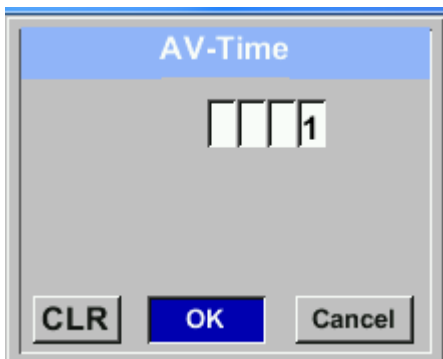

The time period for averaging can be entered here.  
Input values of -1440 1 [minutes] are possible.  
For average values see display window 3 + 4

8.3.1.5 Setting of Zeropoint and Low-flow cut off

Setup → Sensor Setup → ZP Adjust

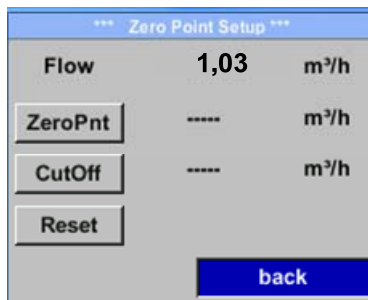

To make changes, first select a menu with button „ $\Delta$ “ and confirm selection by pressing „OK“.

Setup → Sensor Setup → ZP Adjust → ZeroPnt

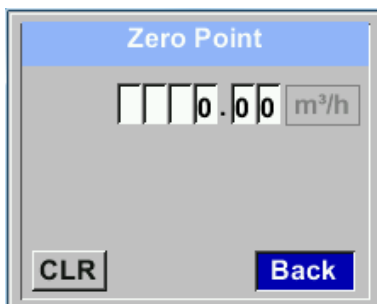

When, without flow, the installed sensor shows already a flow value of  $> 0$  m<sup>3</sup>/h herewith the zero point of the characteristic could be reset.

For an input / change of the value select with the button „ $\Delta$ “ the respective number position and activate it with „OK“.

By pressing „ $\Delta$ “ the position value is incremented by 1. Confirm the input with „OK“ and activate next number position.

Leave menu with button „Back“

Setup → Sensor Setup → ZP Adjust → CutOff

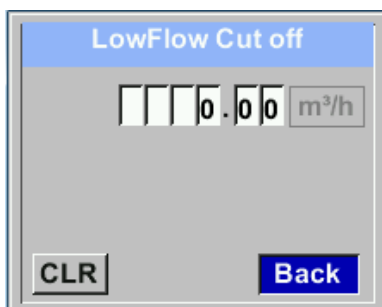

With the low-flow cut off activated, the flow below the defined "LowFlow Cut off" value will be displayed as 0 m<sup>3</sup>/h and not added to the consumption counter.

For an input / change of the value select with the button „ $\Delta$ “ the respective number position and activate it with „OK“.

By pressing „ $\Delta$ “ the position value is incremented by 1. Confirm the input with „OK“ and activate next number position.

Leave menu with button „Back“

Setup → Sensor Setup → ZP Adjust t → Reset



By selection of „Reset“ all settings for „ZeroPnt“ and „CutOff“ are reset.

Menu item to be select with button „ $\Delta$ “ and confirm the reset with „OK“.

Leave menu with button „Back“



### 8.3.2 Modbus Setup

The Flow sensors KEC-1 comes with a Modbus RTU Interface. Before commissioning the sensor the communication parameters

- Modbus ID, Baudrate, Parity und Stop bit

must be set in order to ensure the communication with the Modbus master.

#### Settings → Modbus Setup

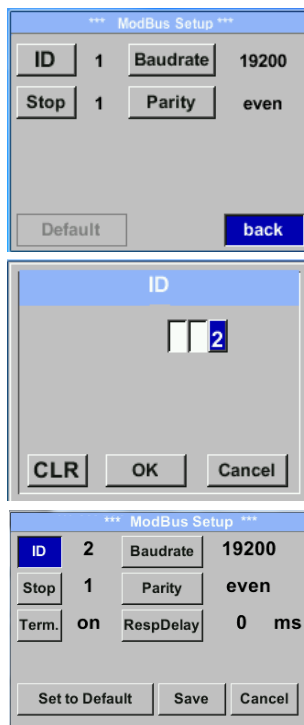

For changes, e.g. the sensor ID, first select by pressing key „△“ the field **“ID”** and then key **“OK”**.

Select the desired position by pressing the **“>”** and select with **“OK”** button.

Change values by pressing the **„△“** values takeover by pressing **“OK”**.

Inputs for remaining information is analog.

Saving the changes by pressing **“Save”**, therefore select it first with key **„△“** and afterwards confirm it with **“OK”**.

To set back to default values please press button **“Set to Default”**

**Default values out of factory:**

Modbus ID:	1
Baud rate:	19200
Stopbit:	1
Parity:	even

**Remark:** If the sensor placed at the end of the Modbus system a termination is required. Therefore the enclosed 120R resistor is to be connected at Pin 1 and Pin 3 of connector „X2“

**8.3.2.1 Modbus Settings (2001...2005)**

Modbus Register	Register Address	No.of Byte	Data Type	Description	Default Setting	Read Write	Unit /Comment
2001	2000	2	UInt16	Modbus ID	1	R/W	Modbus ID 1...247
2002	2001	2	UInt16	Baudrate	4	R/W	0 = 1200 1 = 2400 2 = 4800 3 = 9600 4 = 19200 5 = 38400
2003	2002	2	UInt16	Parity	1	R/W	0 = none 1 = even 2 = odd
2004	2003	2	UInt16	Number of Stopbits		R/W	0 = 1 Stop Bit 1 = 2 Stop Bit
2005	2004	2	UInt16	Word Order	0xABCD	R/W	0xABCD = Big Endian 0xCDAB = Middle Endian

**8.3.2.2 Values Register (1001 ...1500)**

Modbus Register	Register Address	No.of Byte	Data Type	Description	Default	Read Write	Unit /Comment
1101	1100	4	Float	Flow in m <sup>3</sup> /h		R	
1109	1108	4	Float	Flow in Nm <sup>3</sup> /h		R	
1117	1116	4	Float	Flow in m <sup>3</sup> /min		R	
1125	1124	4	Float	Flow in Nm <sup>3</sup> /min		R	
1133	1132	4	Float	Flow in ltr/h		R	
1141	1140	4	Float	Flow in Nltr/h		R	
1149	1148	4	Float	Flow in ltr/min		R	
1157	1156	4	Float	Flow in Nltr/min		R	
1165	1164	4	Float	Flow in ltr/s		R	
1173	1172	4	Float	Flow in Nltr/s		R	
1181	1180	4	Float	Flow in cfm		R	
1189	1188	4	Float	Flow in Ncfm		R	
1197	1196	4	Float	Flow in kg/h		R	
1205	1204	4	Float	Flow in kg/min		R	
1213	1212	4	Float	Flow in kg/s		R	
1221	1220	4	Float	Flow in kW		R	

## Operation

Modbus Register	Register Address	No.of Byte	Data Type	Description	Default	Read Write	Unit /Comment
1269	1268	4	UInt32	Consumption m <sup>3</sup> before comma	x	R	
1275	1274	4	UInt32	Consumption Nm <sup>3</sup> before comma	x	R	
1281	1280	4	UInt32	Consumption ltr before comma	x	R	
1287	1286	4	UInt32	Consumption Nltr before comma	x	R	
1293	1292	4	UInt32	Consumption cf before comma	x	R	
1299	1298	4	UInt32	Consumption Ncf before comma	x	R	
1305	1304	4	UInt32	Consumption kg before comma	x	R	
1311	1310	4	UInt32	Consumption kWh before comma	x	R	
1347	1346	4	Float	Velocity m/s			
1355	1354	4	Float	Velocity Nm/s			
1363	1362	4	Float	Velocity Ft/min			
1371	1370	4	Float	Velocity NFt/min			
1419	1418	4	Float	GasTemp °C			
1427	1426	4	Float	GasTemp °F			

### Remark:

- For more additional Modbus values please refer to  
KECXX\_Modbus\_RTU\_Slave\_Installation\_1.00\_EN.doc

### 8.3.3 Pulse /Alarm

Setup → Sensor Setup → Pulse/ Alarm

Relay Mode:	Alarm
Unit	°C
Value	20.0
Hyst.	5.0
Hi-Lim.	OK Cancel

*** Pulse / Alarm ***	
Relay Mode:	Alarm
Unit:	°C
Value	20.0
Hyst.	5.0
Hi-Lim.	OK Cancel

*** Pulse / Alarm ***	
Relay Mode:	Pulse
Unit:	m³
Value	0.1
Polarity	pos.
Pls per second at max Speed: 0	
Back	

The galvanically isolated output can be defined as pulse- or alarm output. Selection of field „**Relay Mode**“ with key „**Δ**“ and change modus by pressing key „**OK**“.

For alarm output following units could be chosen: kg/min, cfm, ltr/s, m³/h, m/s, °F, °C and kg/s.

„**Value**“ defines the Alarm value, „**Hyst.**“ defines the desired hysteresis and with „**Hi-Lim**“ or „**Lo-Lim**“ the alarm settings when the alarm is activated  
 Hi-Lim: Value over limit  
 Lo-Lim: Value under limit

For the pulse output following units could be chosen: kg, cf, ltr and m³. The pulse value definition to be done in menu „**Value**“ (0.1, 1, 10, 100). With „**Polarity**“ the switching state could be defined.  
 Pos. = 0 → 1 neg. 1 → 0



#### 8.3.3.1 Pulse output

The maximum frequency for pulse output is 50 pulses per second (50Hz). The Pulse output is delayed by 1 second.

Pulse value	[m³ /h]	[m³ /min]	[l/min]
0.1 ltr / Pulse	1,8	0,3	300
1ltr / Pulse	18	3	3000
0.1m³ / Pulse	18000	300	300000
1 m³ / Pulse	180000	3000	3000000

Table 1 Maximum flow for pulse output

Entering pulse values that are not allow a presentation to the full scale value, are not allowed. Entries are discarded and error message displayed.

### 8.3.4 User Setup

Settings → UserSetup

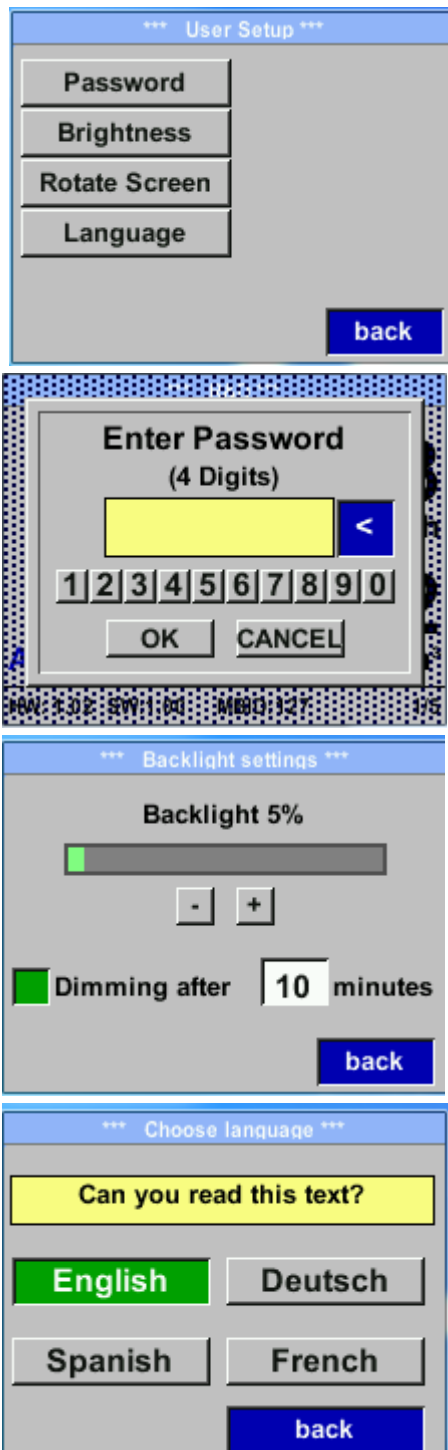

To make changes, first select a menu with button „**Δ**“ and confirm selection by pressing „**OK**“.

It is possible to define a password. The required password length is 4 digits.

Please select with button „**Δ**“ a figure and confirm it with „**OK**“. Repeat this 4 times.

With „**<**“ the last figure could be deleted.

Password input have to be inserted twice.

Confirmation of input/password by pressing „**OK**“.

**Factory settings for password at the time of delivery: 0000 (4 times zero).**

With „**Brightness**“ it is possible to adjust the backlight / display brightness.

By activation „**Dimming after**“ and entering a time a display dimming could be set.

With „**Rotate Screen**“ the display information could be rotated by 180°.

Currently 4 languages have been implemented and could be selected with button „**Δ**“.

Change of language by confirming with „**OK**“. Leaving the menu with button „**back**“.

### 8.3.5 Advanced

*Settings* → *Advanced*

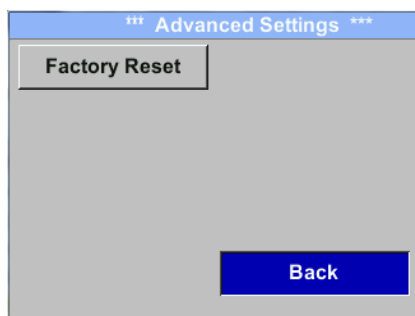

By pressing „**Factory Reset**“ the sensor is set back to the factory settings.

8.3.6 4 -20mA

Settings → 4-20mA

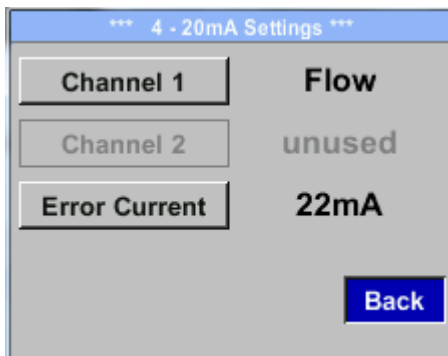

To make changes, first select a menu with button „ $\Delta$ “ and confirm selection by pressing „OK“.

Settings → 4-20mA → Channel 1

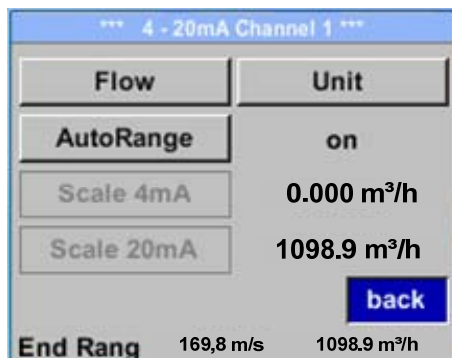

The 4-20 mA Analogue output of the Sensor KEC can be individually adjusted.

It is possible to assign following values „Temperature“, „Velocity“ und „Flow“ to the channel CH 1.

To make changes, first select the value item with button „ $\Delta$ “ .and confirm  
 Moving between the different measurements values or to deactivate the 4-20mA with setting to „unused“ by pressing „OK“.

To the selected measurement value a corresponding / appropriate unit needs to be defined. Select „Unit“ with „ $\Delta$ “ and open menu with „OK“. Select required unit with „ $\Delta$ “ and take over by pressing „OK“.

Here e.g. for the measurement value Flow, procedure for the other measurements values is analog.

For saving the changes done press button „Save“ to discard the changes press button „Cancel“.

Leaving the menu with „Back“.

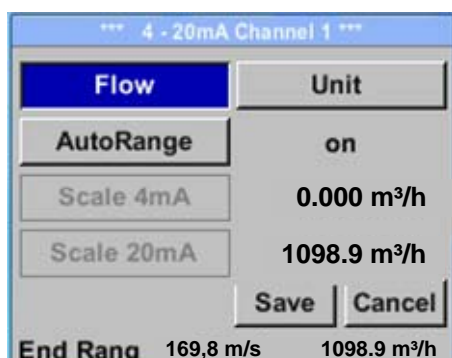
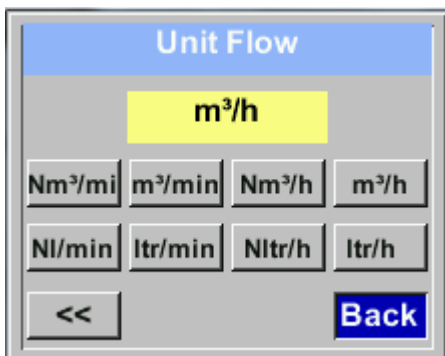

Settings → 4-20mA → Channel 1 → AutoRange

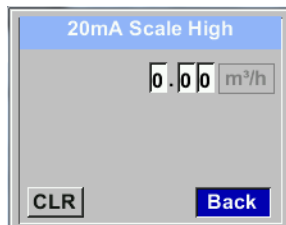
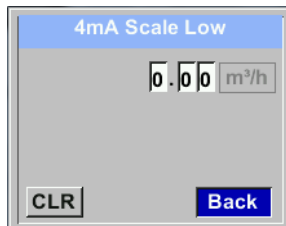
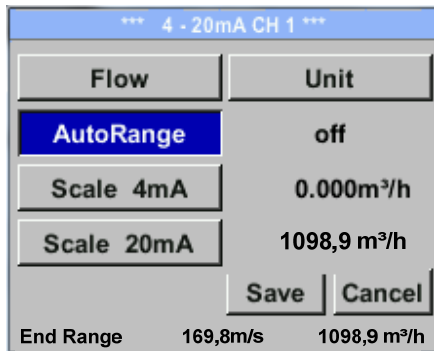

The scaling of the 4-20mA channel can be done automatically "Auto Range = on" or manual "AutoRange = off" .

With button „ $\Delta$ “ select the menu item „AutoRange“ select with „OK“ the desired scaling method. (Automatically or manually)

In case of **AutoRange = off** with „Scale 4mA“ und „Scale 20mA“ the scale ranges needs to be defined.

Select with button „ $\Delta$ “ the item „Scale 4mA“ or „Scale 20mA“ and confirm with „OK“ .

Input of the scaling values will be analogous as described before for value settings.

Using „CLR“ clears up the complete settings at once.

For „Auto on“ , the max. scaling is calculated based on the inner tube diameter, max. measurement range and the reference conditions settings.

Take over of the inputs with „Save“ and leaving the menu with „Back“ .

**Settings → 4-20mA → Error Current**

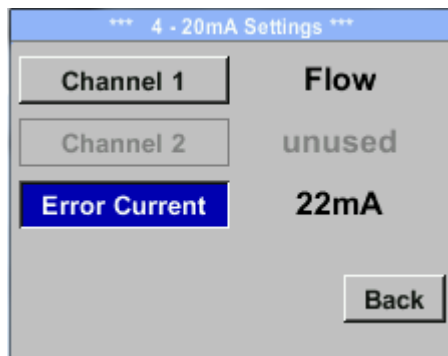

This determines what is output in case of an error at the analog output.

- 2 mA Sensor error / System error
- 22 mA Sensor error / System error
- None Output according Namur (3.8mA – 20.5 mA)  
 < 4mA to 3.8 mA Measuring range under range  
 >20mA to 20.5 mA Measuring range exceeding

To make changes first select a menu item "Current Error" with button „ $\Delta$ “ and then select by pressing the „OK“ the desired mode

For saving the changes done press button „Save“ to discard the changes press button **“Cancel”**.

Leaving the menu with „Back“.



### 8.3.7 KEC-1 Info

Setup → Sensor Setup → Info

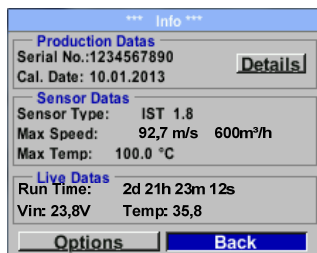

Here you get a brief description of the sensor data incl. the calibration data.

Under **Details**, you are able to see in addition the calibration conditions.

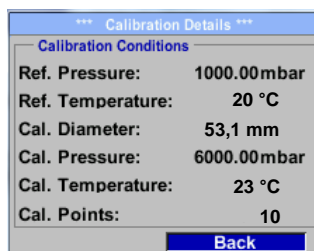

## 8.4 MBus

### 8.4.1 Default Settings communication

Primary Address*:	1
ID:	Serialnumber of Sensor
Baud rate*:	2400
Medium*:	depending on medium (Gas or Compressed Air)

Both addresses, Primary address and ID, could be automatic searched in the M-Bus system.

### 8.4.2 Default values transmitted

Value 1 with [Unit]*:	Consumption [m³]
Value 2 with [Unit]*:	Flow [m³/h]
Value 3 with [Unit]*:	Gas temperature [°C]

\*All Values could be changed / preset in production or with Kobold Service software

## 9 Supplementary Documentation

- Supplementary Documentation for Ex-Version (in preparation)

**10 EU Declaration of Conformance**

We, KOBOLD Messring GmbH, Hofheim-Ts, Germany, declare under our sole responsibility that the product:

**Thermal Energy Flowmeter for gases**

**Model: KEC-1**

to which this declaration relates is in conformity with the standards noted below:

**EN 55011:2011** Industrial, scientific and medical equipment - Radio-frequency disturbance characteristics - Limits and methods of measurement

**EN 61326-1:2013** Electrical equipment for measurement, control and laboratory use - EMC requirements - Part 1: General requirements

Also the following EU guidelines are fulfilled:

**2014/30/EU**  
**2011/65/EU**

**EMC Directive**  
**RoHS**

Hofheim, 07. Febr. 2017



H. Peters  
General Manager



M. Wenzel  
Proxy Holder

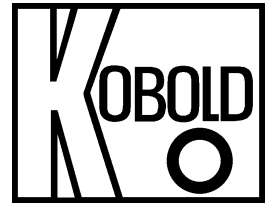

**Operating Instructions  
for  
Thermal Energy Flowmeter  
for gases**

**Model: KEC-2**



## **I. Foreword**

Dear customer,

thank you very much for deciding in favour of the KEC-2. Please read this installation and operation manual carefully before mounting and initiating the device and follow our advice. A riskless operation and a correct functioning of the KEC-2 are only guaranteed in case of careful observation of the described instructions and notes

### **Manufactured and sold by:**

Kobold Messring GmbH  
Nordring 22-24  
D-65719 Hofheim  
Tel.: +49(0)6192-2990  
Fax: +49(0)6192-23398

**II. Table of Content**

<b>I. Foreword .....</b>	<b>2</b>
<b>II. Table of Content .....</b>	<b>3</b>
<b>1 Pictograms and Symbols.....</b>	<b>5</b>
<b>2 Signalwords according ISO 3864 and ANSI Z 535.....</b>	<b>5</b>
<b>3 Safety instructions .....</b>	<b>6</b>
3.1 Intended Use.....	7
3.2 Installation and commissioning .....	7
<b>4 Technical data.....</b>	<b>8</b>
<b>4.1 Signal circuits.....</b>	<b>9</b>
4.1.1 Modbus .....	9
4.1.2 Current output.....	9
4.1.2.1 Aktive.....	9
4.1.2.2 Passive .....	9
4.1.3 Pulse .....	9
4.1.4 Alarm.....	9
<b>4.2 Measuring range flow KEC-2 .....</b>	<b>10</b>
<b>5 Dimensions .....</b>	<b>11</b>
5.1 Dimension KEC-2 Thread-version.....	11
5.2 Dimension KEC-2 Flanged-version .....	12
<b>6 Installation.....</b>	<b>13</b>
6.1 Pipe/tube requirements .....	13
6.2 Inlet / outlet runs .....	13
6.2.1 Installation of KEC-2.....	14
6.3 Alignment Display (Housing).....	14
6.4 Tightening torques.....	14
<b>7 Connection diagram .....</b>	<b>15</b>
7.1 Cable glands - clamping ranges.....	15
7.2 Connector pin assignment.....	16
7.3 Wire connection .....	17
7.3.1 General: .....	17
7.3.2 Power supply .....	17
7.3.3 Modbus (termination):.....	17
7.3.4 Pulse Output.....	17
<b>8 Operation KEC-2 .....</b>	<b>18</b>
8.1 Main menu (Home).....	18
8.1.1 Intialization .....	18
8.2 Main menu .....	19

## Table of Content

<b>8.3</b>	<b>Settings</b> .....	<b>19</b>
8.3.1	Sensor Setup .....	20
8.3.1.1	Input / change tube diameter.....	20
8.3.1.2	Input / change consumption counter .....	21
8.3.1.3	Definition of the units for flow, velocity, temperature and pressure.....	21
8.3.1.4	Definition of the reference conditions .....	22
8.3.1.5	Setting of Zeropoint and Low-flow cut off .....	24
8.3.2	Modbus Setup.....	25
8.3.2.1	Modbus Settings (2001...2005).....	26
8.3.2.2	Values Register (1001 ...1500) .....	26
<b>Remark:</b>	.....	<b>27</b>
8.3.3	Pulse /Alarm.....	28
8.3.3.1	Pulse output.....	28
8.3.4	User Setup .....	29
8.3.5	Advanced .....	30
8.3.6	4 -20mA .....	31
8.3.7	KEC-2 Info .....	33
<b>8.4</b>	<b>MBus</b> .....	<b>33</b>
8.4.1	Default Settings communication .....	33
8.4.2	Default values transmitted .....	33
<b>9</b>	<b>Supplementary Documentation</b> .....	<b>34</b>
<b>10</b>	<b>EU Declaration of Conformance</b> .....	<b>35</b>

## 1 Pictograms and Symbols



General Warning symbol (Danger, Warning, Caution)



General note



Installation- and Instruction manual to consider (on Nameplate)



Installation- and Instruction manual to consider

## 2 Signalwords according ISO 3864 and ANSI Z 535

- Danger!** Imminent danger  
As a consequence of incorrect handling: serious personal injury or death
- Warning!** Possible hazard  
As a consequence of incorrect handling: possible serious injury or death
- Caution!** Imminent hazard  
As a consequence of incorrect handling: possible personal injury or damage
- Note!** Possible hazard  
As a consequence of incorrect handling: possible personal injury or damage
- Important!** Additional notes, information, tips  
As a consequence of incorrect handling: Disadvantages in operation and maintenance, no danger



### 3 Safety instructions



**Please check whether this manual corresponds with the device type.**

Please attend to all notes indicated in this instruction manual. It contains essential information, which has to be followed during installation, operation and maintenance. Therefore this instruction manual has to be read categorically by the technician as well as by the responsible user/qualified personnel before installation, initiation and maintenance

Regional and national regulations respectively, have to be observed in addition to this instruction manual if necessary.

This instruction manual has to be available at any time at the operation site of the DS 500.

Ensure that the KEC-2 operates within the permissible and listed limits on the nameplate. Otherwise there is a risk to human and material, and it may occur functional and operational disturbances

In case of any obscurities or questions with regard to this manual or the instrument please contact Kobold GmbH..



**Warning!**

**Risk of injury in case of inadequate qualification!**

Improper handling can result in significant personal injury and damage.

All activities described in this operating instructions manual must be carried out only by qualified personnel qualifications described below.

**Professionals (Technical staff)**

The technical staff is based on his education/training, his knowledge of measurement and control technology as well of the local regulations, standards and guidelines in the position to do the work as described and to identify the possible hazards.

Special working conditions require further appropriate knowledge, e.g. of aggressive media.



**Caution!**

**Malfunction of KEC-2**

Faulty installation and insufficient maintenance may lead to malfunctions of the KEC-2, which may affect the display and open to misinterpretation.



**Danger!**

**Inadmissible operating parameters!**

By exceeding or falling short of limits there is a risk for people and material, in addition there may occur further functional and operational disturbances.

**Measures:**

- Make sure that the KEC-2 operates only within the permissible and listed limits on the nameplate
- Ensure the operation within the performance data of KEC-2 in connection with the application
- Do not exceed the admissible storage and transportation temperature.

**Additional safety information:**

- When installing and operating the relevant national regulations and safety rules must also be observed.



When using the Flow-/ Consumption sensors KEC-2 Ex in gas hazardous areas the special requirements specified in the Ex documentation must be observed (in preparation).

### 3.1 Intended Use

The instrument described in this manual is exclusively to use for measuring the thermal mass flow of gases. At the same time, the gas temperature is measured too.

The KEC-2 can be configured for measuring a predetermined range of pure gases or of gas mixtures.

Consumption measurement of gases such as Air, oxygen, nitrogen, carbon dioxide, argon, etc. and with ATEX approval explosive gases such as natural gas, methane, propane and hydrogen.

Improper or incorrect use the operational reliability will be canceled. The manufacturer is not liable for any damage resulting by improper or incorrect use.

### 3.2 Installation and commissioning

- Installation, electrical installation, commissioning, operation and maintenance of the device must only be carried by qualified personnel, which were authorized by the plant operator. The personnel must read the operating instructions and understand and follow their instructions.
- If carrying out welding work on the pipeline the grounding of the welding unit is not allowed to be done over the KEC-2 itself.
- The installer has to ensure that the KEC-2 is connected according to the electrical connection diagrams properly. The sensor must be grounded, unless special protective measures have been taken (e.g. galvanically isolated power supply)
- The existing/ applicable national regulations governing opening and repair of the device have to be applied.
- When using the KEC-2 (ATEX Version) hazardous areas, in addition with the standard manual a separate Ex documentation is enclosed. The installation instructions and connection values indicated in these must also be observed (in preparation).
- The device fulfills the general safety requirements in accordance with EN 61010-1, the EMC requirements of IEC / EN 61326 and NAMUR recommendation NE 43.

## 4 Technical data

<b>Measures:</b>	mass flow, consumption flow speed, temperature
<b>Measuring principle:</b>	thermal mass flow sensor
<b>Medium temperature range:</b>	-40 ... 180 °C Probe (ATEX-Version -20 °C ... 120 °C) (in preparation)
<b>Operating temperature range:</b>	-20 ... 70 °C
<b>Operating pressure:</b>	50 bar
<b>Power supply:</b>	18 ... 36 VDC
<b>Power consumption:</b>	max. 5 W
<b>Output:</b>	Modbus RTU (acc. EIA/TIA-485 Standard) 2 x 4...20 mA active (optional passive) RL < 500Ohm galvanically isolated pulse (Pulse weight freely selectable, Alarm max. 48 Vdc 0.5 A, optional: Modbus TCP, HART, ProfibusDP, Profi Net,
<b>Accuracy:</b> Standard version* (m.v. of meas. value) (f.s. of full scale)	± 1.5 % m.v. ± 0.3 % f.s.
<b>Accuracy:</b> Precision version* (m.v. of meas. value) (f.s. of full scale)	± 1.0 % m.v. ± 0.3 % f.s.
<b>Repeatability :</b>	0,25% m.v in case of correct mounting(mounting aid, position,inlet section
<b>Accuracy indications:</b>	referred to ambient temperature 22 °C +/-2 °C, system pressure 6 bar
<b>Response time:</b>	t90 < 3 s
<b>Display:</b>	2" TFT Color Display (320 x 240)
<b>Material:</b>	Housing aluminum die cast, probe stainless steel1,4571
<b>Protection class</b>	IP67

\* Reference conditions for Temperature and pressure can be freely set, standard conditions are 0 ° and 1013 mbar.

## 4.1 Signal circuits

### 4.1.1 Modbus

- According Standard EIA/TIA-485

### 4.1.2 Current output

#### 4.1.2.1 Aktive

- Galvanically isolated
- 4 ... 20 mA
- $R_L < 500 \text{ Ohm}$

#### 4.1.2.2 Passive

- Galvanically isolated
- 4 ... 20 mA
- $R_L < 500 \text{ Ohm}$
- $V_{in} 12\text{-}36 \text{ Vdc}$

### 4.1.3 Pulse

- Galvanically isolated (dry contact)
- Passive: 48 Vdc , 500 mA
- Max. pulse output freq. 50 Hz

### 4.1.4 Alarm

- Galvanically isolated (dry contact)
- Max. 48 Vdc, 500 mA

4.2 Measuring range flow KEC-2

Innerradius of pipe			Full scale value in Nm <sup>3</sup> /h					
Inch	mm	DN	Air <sup>2)</sup>	N <sub>2</sub> <sup>3)</sup>	Ar <sup>3)</sup>	O <sub>2</sub> <sup>3)</sup>	CO <sub>2</sub> <sup>3)</sup>	Methane <sup>3)</sup>
								Natural gas (CH <sub>4</sub> )
R 1/2"	16.1	DN 15	90	80	140	85	90	50
R 3/4"	21.7	DN 20	170	155	275	165	175	105
R 1"	27.3	DN 25	290	260	460	280	290	170
R1 1/4"	36	DN 32	530	470	830	505	525	310
R 1 1/2"	41.9	DN 40	730	650	1140	695	720	430
R 2"	53.1	DN 50	1195	1060	1870	1140	1185	705

<sup>2)</sup> Referred to DIN 1945/ ISO 1217 (20°C 1000mbar) and compressed air

<sup>3)</sup> Adjusted to DIN 1343: 0°C, 1013mbar

## 5 Dimensions

### 5.1 Dimension KEC-2 Thread-version

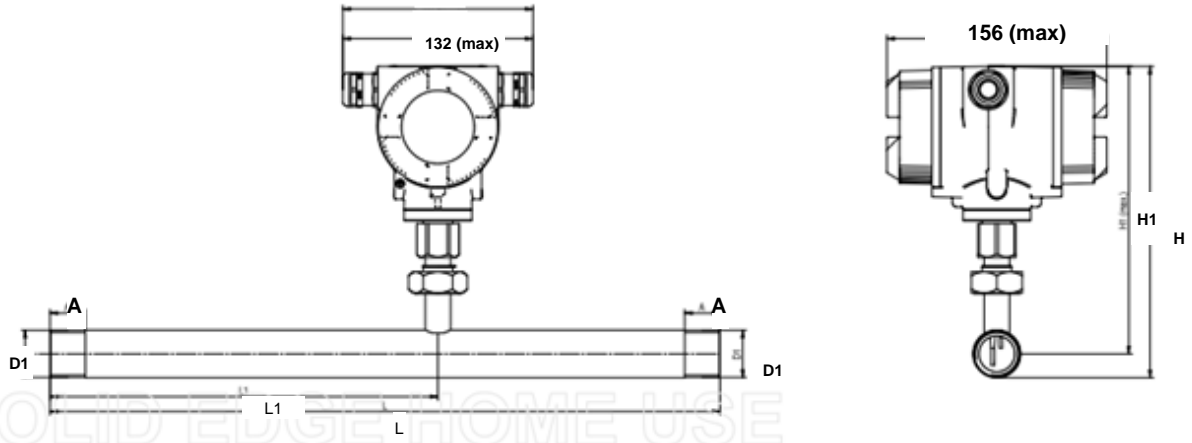

KEC-2 thread version							
Connection thread	Outer pipe dia. [mm]	Inner pipe dia. [mm]	L [mm]	L1 [mm]	H [mm]	H1 [mm]	A [mm]
1/2"	21.3	16.1	300	210	176.4	165.7	20
3/4"	26.9	21.7	475	275	179.2	165.7	20
1"	33.7	27.3	475	275	182.6	165.7	25
1 1/4"	42.4	36	475	275	186.9	165.7	25
1 1/2"	48.3	41.9	475**	275	189.9	165.7	25
2"	60.3	53.1	475**	275	195.9	165.7	30

\*\* Attention: Shortend inlet section! Please observe the recommended minimum inlet section (lenght = 10x inner diameter)

5.2 Dimension KEC-2 Flanged-version

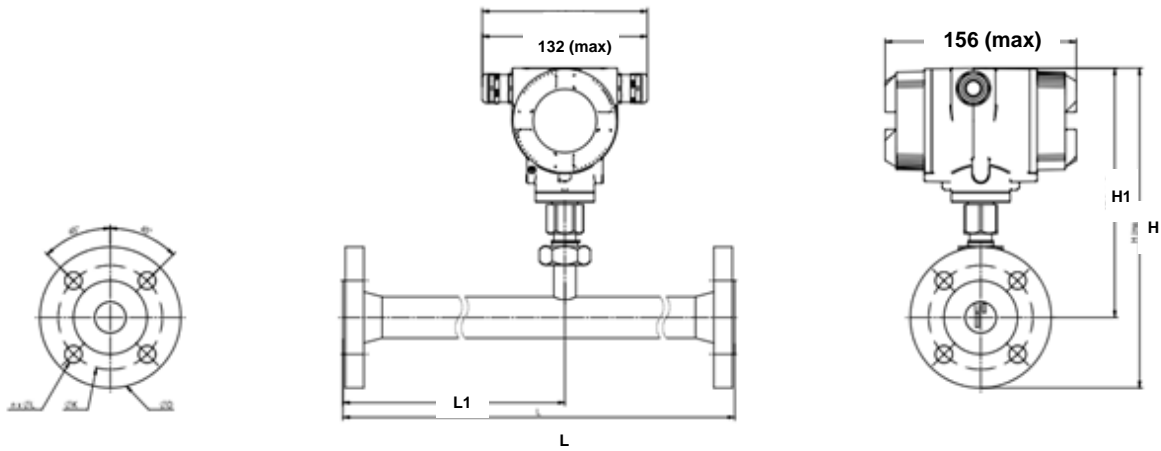

KEC-2 flanged version							Flange DIN EN 1092-1		
Measuring section	Outer pipe dia. [mm]	Inner pipe dia. [mm]	L [mm]	L1 [mm]	H [mm]	H1 [mm]	ØD [mm]	ØK [mm]	n x ØL
DN 15	21.3	16.1	300	210	213.2	165.7	95	65	4 x 14
DN 20	26.9	21.7	475	275	218.2	165.7	105	75	4 x 14
DN 25	33.7	27.3	475	275	223.2	165.7	115	85	4 x 14
DN 32	42.4	36	475	275	235.7	165.7	140	100	4 x 18
DN 40	48.3	41.9	475**	275	240.7	165.7	150	110	4 x 18
DN 50	60.3	53.1	475**	275	248.2	165.7	165	125	4 x 18

\*\* Attention: Shortened inlet section! Please observe the recommended minimum inlet section (length = 10x inner diameter)

## 6 Installation

### 6.1 Pipe/tube requirements

- Correctly sized gaskets
- Correct aligned flanges and gaskets
- Diameter mismatch at the pipe junctions should be avoided but must be less than 1mm. For further information see ISO 14511
- Ensure clean pipes after installation

### 6.2 Inlet / outlet runs

The principle of thermal Mass flow measurement is very sensitive against disturbances. Therefore, it is necessary to ensure the recommended inlet and outlet runs.

**Table Inlet / Outlet runs**

Flow obstruction before the measurement section	Min length Inlet run (L1)	Min length Outlet run (L2)
Slight curve (elbow < 90°)	12 x D	5 x D
Reduction (Pipe narrows to the measurement section)	15 x D	5 x D
Expansion (Pipe expands to the measurement section)	15 x D	5 x D
90° elbow or T-piece	15 x D	5 x D
2x elbow á 90° in einer Ebene	20 x D	5 x D
2x elbow á 90° 3-dimensional	35 x D	5 x D
Control valve	45 x D	5 x D

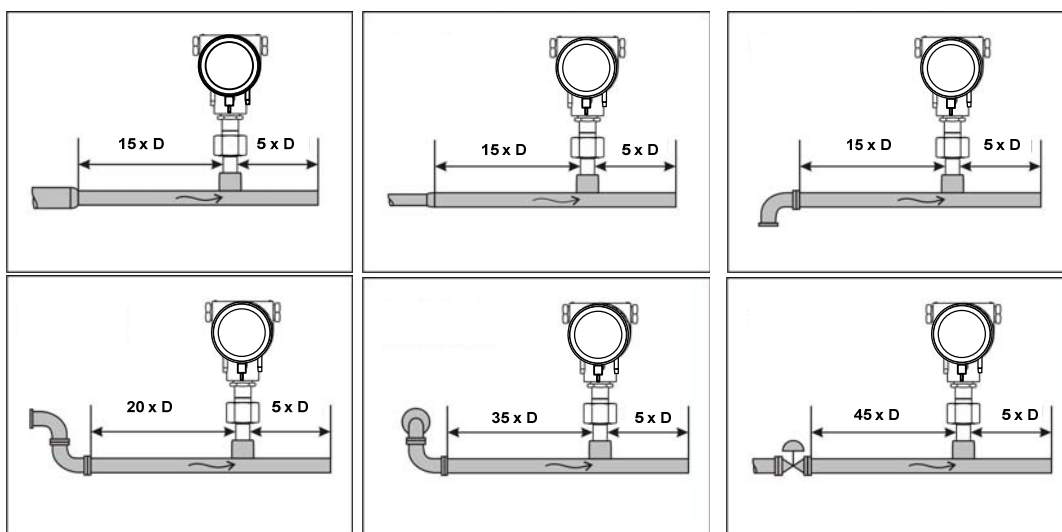

The values represent the min.lengths. In case the min. inlet / outlet runs could not be ensured, it must be expected to get increased or significant deviations of the measurement values.



### 6.2.1 Installation of KEC-2

The sensor KEC-2 is pre-supplied with the measuring section.

### 6.3 Alignment Display (Housing)

The sensor housing KEC-2 can be turned in both directions, max. 345 °. For this purpose, the housing-connecting nut must be opened. The housing can be rotated to the desired position, a bigger rotation angle is prevented by internal stop pins. After that, the housing-connecting nut is firmly retighten

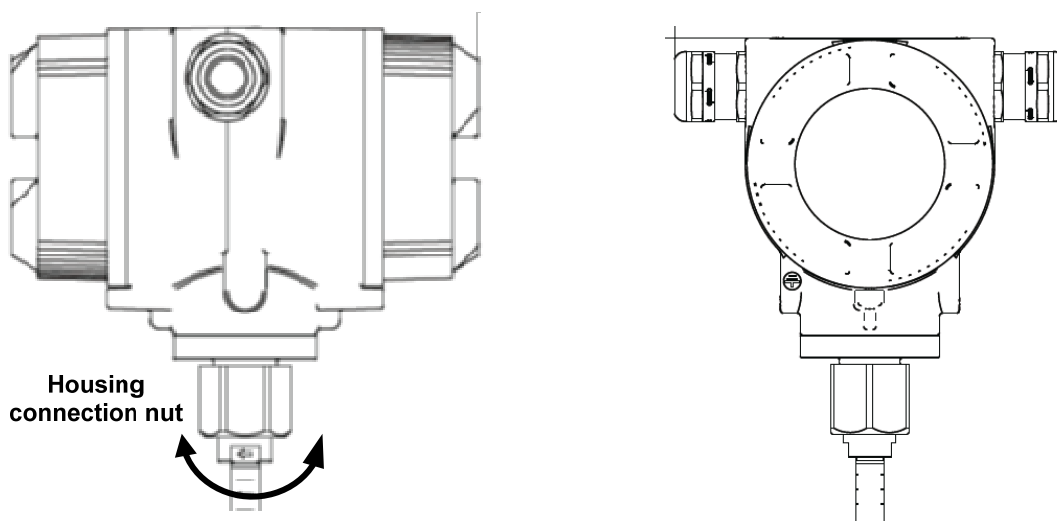

### 6.4 Tightening torques

To secure and guarantee of the function and tightness following tightening torques have to be applied, see table 1.

Table 1

Pos	Description	Tightening torque [Nm]
20	KEC-2 cover with glass	3
30	KEC-2 cover without window	3
50	Grub screw with hexagon socket M4x6 DIN 914 A2	2
130	KEC-2 nut	15
150	Cylinder screw DIN 6912 - M5x10 A2-70	4

## 7 Connection diagram

### 7.1 Cable glands - clamping ranges

For ensuring the tightness and strain relief, connector cables with the following diameters must be used.

KEC-2 Standard clamping range :       $\varnothing$  5-9 mm

KEC-2 Ex clamping range:               $\varnothing$  5-10 mm (in preparation)

## 7.2 Connector pin assignment

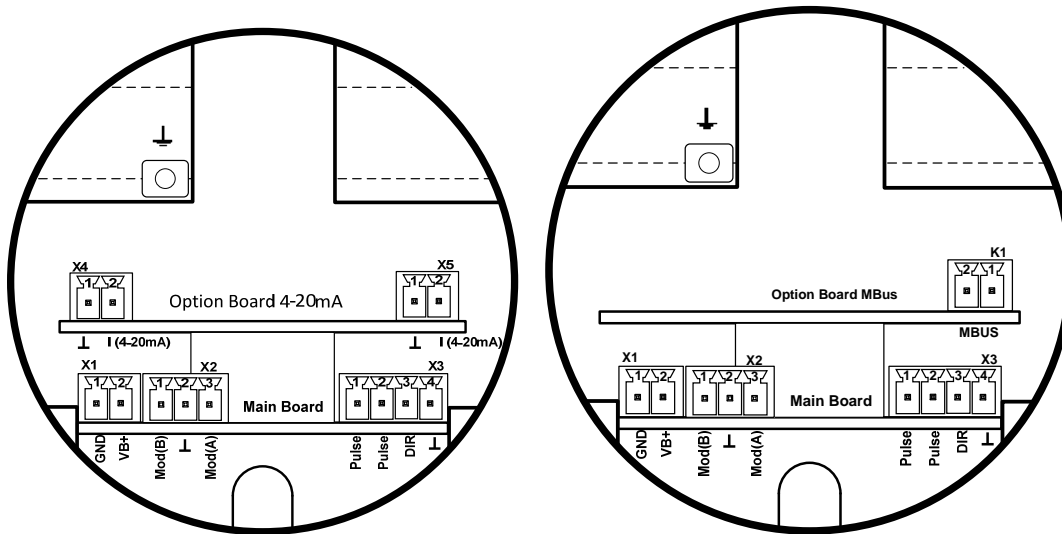

Connector	Pin	Signal description
<b>X1</b> Power supply	1	VB - (GND)
	2	VB+ (12 V – 36 Vdc)
<b>X2</b> Modbus	1	Modbus (B)
	2	Modbus shield
	3	Modbus (A)
<b>X3</b> Analogue output	1	Pulse / Alarm *
	2	Pulse / Alarm *
	3	Direction input
	4	GND
<b>X4</b> Current output 1	1	I- Aktiv*
	2	I+ Aktiv*
<b>X5</b> Current output 2	1	I- Aktiv*
	2	I+ Aktiv*
<b>K1</b> MBus	1	MBus
	2	MBus

\* All analogue outputs are galvanically isolated.

\*\* The analogue outputs are optional as passive output available too.

### 7.3 Wire connection

#### 7.3.1 General:

- Wiring to be done in stainless state only.
- Length of cable skinning to be minimized
- Not used cable entries must be closed with end caps
- Use of cables with cross section of  $\geq 0.25 \text{ mm}^2$

#### 7.3.2 Power supply

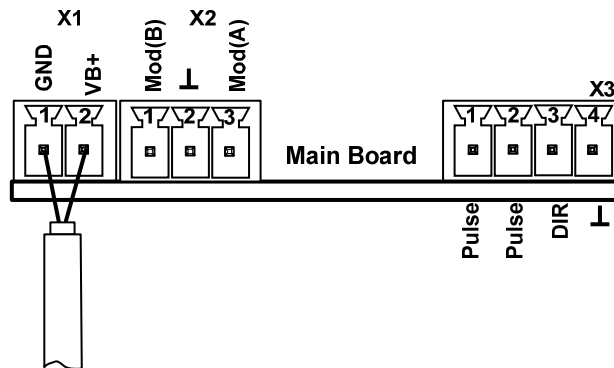

#### 7.3.3 Modbus (termination):

If the sensor placed at the end of the Modbus system a termination is required. Therefore the enclosed 120R resistor is to be connected at Pin 1 and Pin 3 of connector „X2“

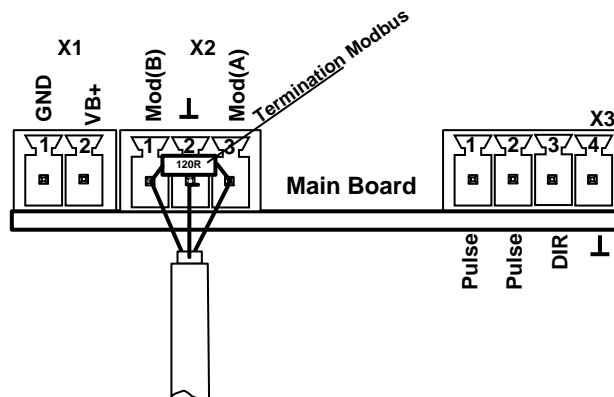

#### 7.3.4 Pulse Output

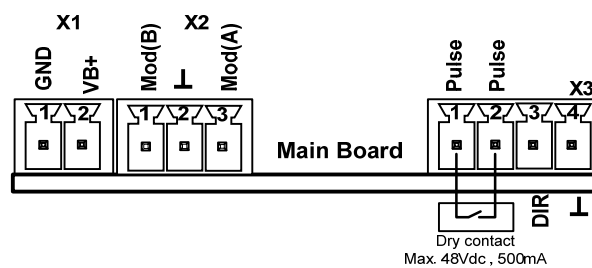

## 8 Operation KEC-2

The operation of the KEC-2 are carried out by 2 optical keys through the glass cover Thus, the KEC-2 can be operated from the outside without opening the cap.

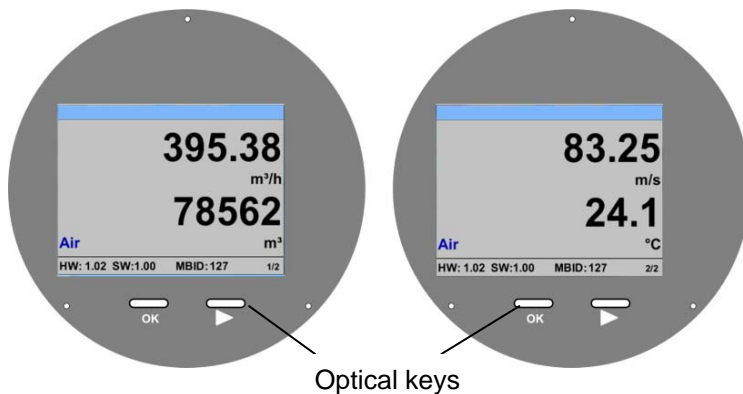

Selection of the individual menu items is done by pressing the ">" and confirm by pressing "OK".

Inputs or changes can be made with all white deposit fields, selcted filed will be highlighted with yellow background.

Words in **green font** refer mainly to the pictures in the section of the chapter, but also on important menu paths or menu items that are related to are in **green font**.

The menu navigation is generally in a **green font**!

The table of contents and chapter references in **blue font** contain links to the respective chapter title.

### 8.1 Main menu (Home)

#### 8.1.1 Intialization

After switching on the KEC-2 the initialized screen is displayed followed by the main menu.

## 8.2 Main menu

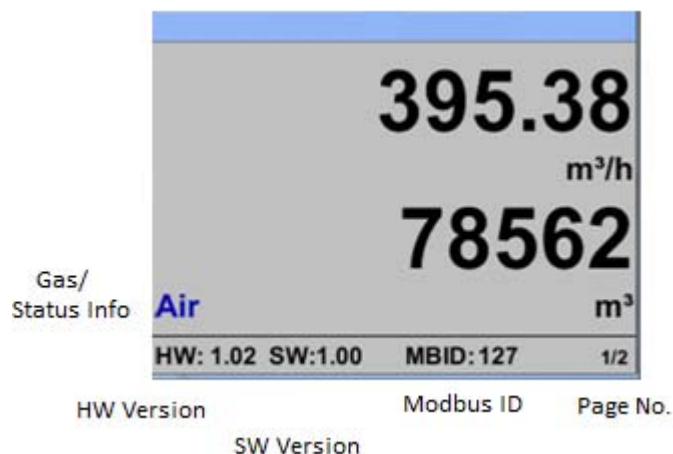

Switching to pages 2-4 or back by pressing key „△“

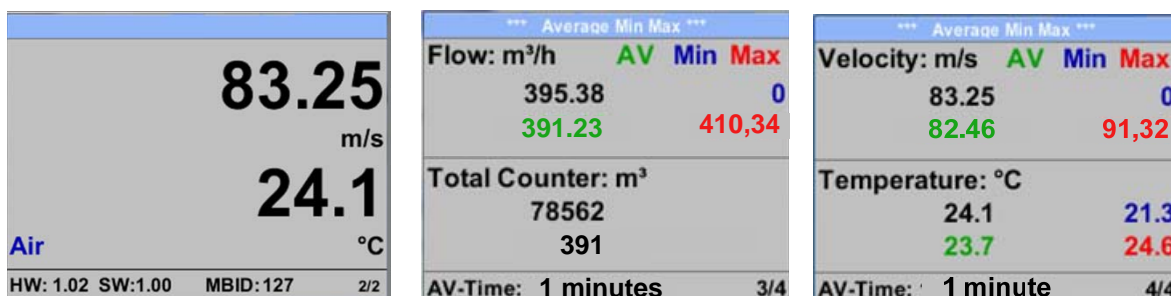

AV-Time ( Period for average value calculation) could be changed under *Sensor Setup.-Advanced- AV-Time*

## 8.3 Settings

The settings menu could accessed by pressing the key „OK“.

But the access to the *settings menu* is password protected.



Factory settings for password at the time of delivery: 0000 (4 times zero).

If required the password could be changed at *Setup-User setup-Password*.

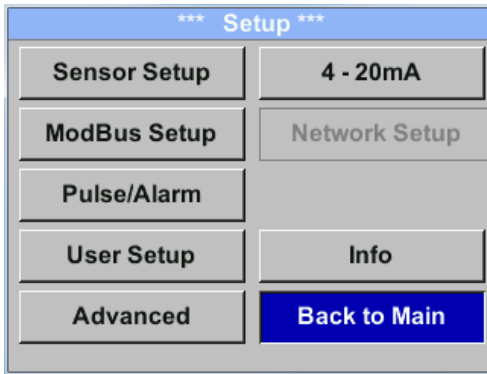

Selection of a menu item or to change a value is done with the key „ $\Delta$ “, a final move to the chosen menu item or takeover of the value change needs the confirmation by pressing the key „OK“

### 8.3.1 Sensor Setup

Setup → Sensor Setup

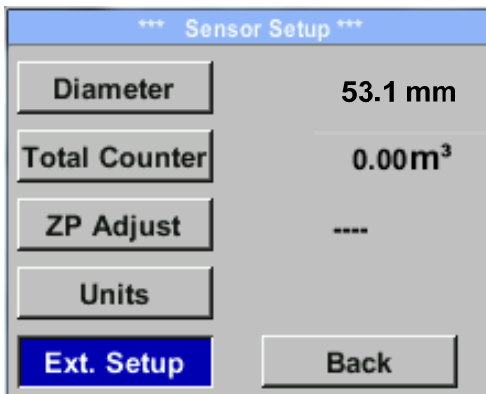

For changes, first select the menu item with key „ $\Delta$ “ and then confirm it with “OK”.

#### 8.3.1.1 Input / change tube diameter

For KEC-2 not adjustable (suspended) as voted on included measuring section with corresponding pipe diameter.

8.3.1.2 Input / change consumption counter

Setup → Sensor Setup → Total Counter → Unit button

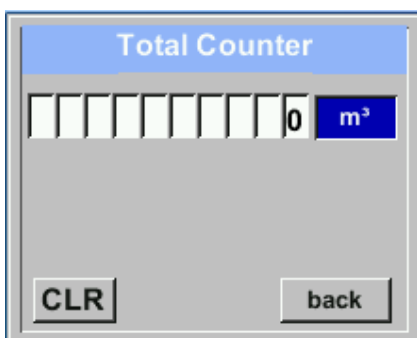
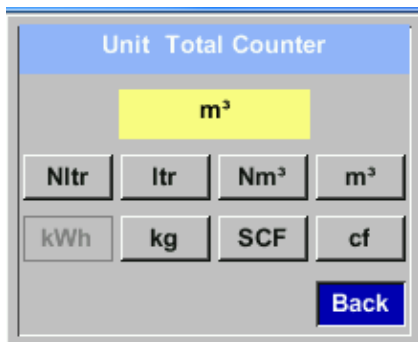

In order to change, e.g. the unit, first select by pressing key „Δ“ the button **“Unit”** and then key **“OK”**.

Select with the key „Δ“ the correct unit and then confirm selection by pressing 2x **„OK”**.

Entering / changing the consumption counter via button „Δ“, select the respective position and activate the position with the **“OK”** button.

By pressing „Δ“ the position value is incremented by 1. Complete with **“OK”** and activate next number position.

Confirm entry by pressing **„OK”**.

**Important!**

When the counter reach 10000000 m<sup>3</sup> the counter will be reset to zero.

8.3.1.3 Definition of the units for flow, velocity, temperature and pressure

Setup → Sensor Setup → Units

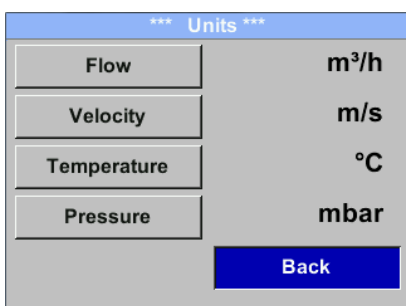

To make changes to the unit for the respective measurement value, first select by pressing „Δ“ the field of the „measurement value“ and activate „it with **„OK”**.

Selection of the new unit with „Δ“

In case the quantity of units selectable are not presentable on one page, pleas move to next page by pressing **„<<”**.

Confirm selection by pressing 2x **„OK”**.

Procedure for all 4 measurement-variables is analogous.

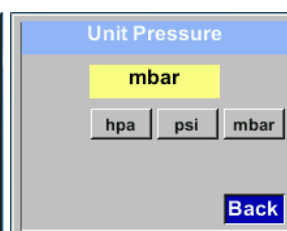
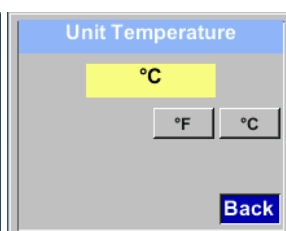
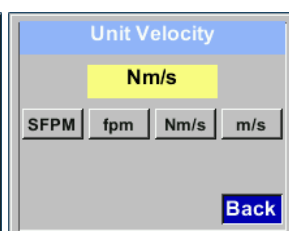
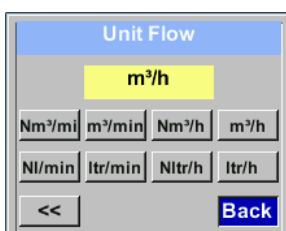



### 8.3.1.4 Definition of the reference conditions

Here can be defined the desired measured media reference conditions for pressure and temperature and times for the filter and averaging.

- Factory pre-setting for reference temperature and reference pressure are 20 °C, 1000 hPa
- All volume flow values (m<sup>3</sup>/h) and consumption values indicated in the display are related to 20 °C and 1000 hPa (according to ISO 1217 intake condition)
- Alternatively 0 °C and 1013 hPa (=standard cubic meter) can also be entered as a reference.
- **Do not enter the operation pressure or the operation temperature under reference conditions!**

Setup → Sensor Setup → Advanced

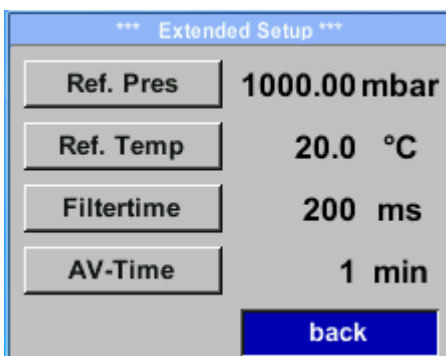

To make changes, first select a menu with button „Δ“ and confirm selection by pressing „OK“.

Setup → Sensor Setup → Advanced → Ref.Pref



In order to change, e.g. the unit, first select by pressing key „Δ“ the field **“Units”** and then key **“OK”**.

Select with the key „Δ“ the correct unit and then confirm selection by pressing 2x **„OK”**.

Input / change of the value by selecting the respective position with button „Δ“ and entering by pressing button **„OK”**.

Setup → Sensor Setup → Advanced → Ref.Temp

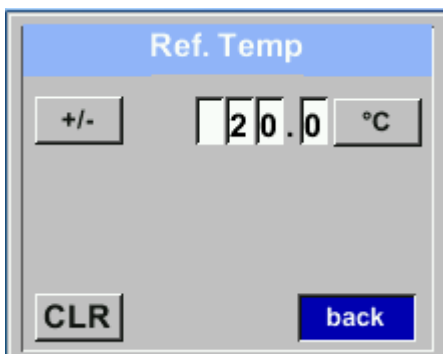

By pressing „Δ“ the position value is incremented by 1. Complete with **“OK”** and activate next number position.

Procedure for changing the reference temperature is the same.

Setup → Sensor Setup → Advanced → *Filtertime*

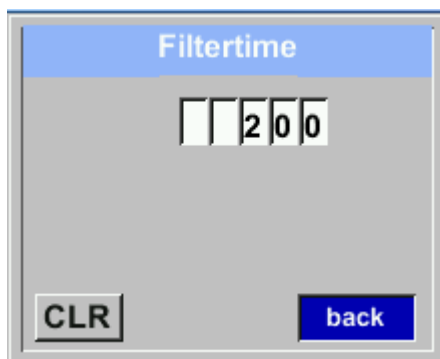

Under item "*Filtertime*" an attenuation can be defined.  
Input values of 0 -10000 in [ms] are possible

Setup → Sensor Setup → Advanced → *AV-Time*

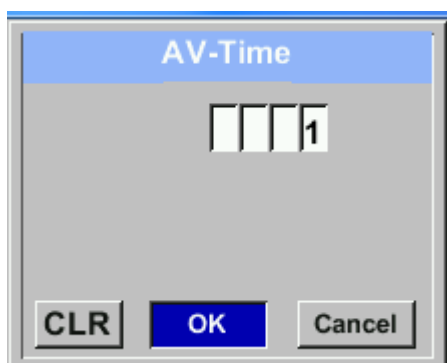

The time period for averaging can be entered here.  
Input values of -1440 1 [minutes] are possible.  
For average values see display window 3 + 4

8.3.1.5 Setting of Zeropoint and Low-flow cut off

Setup → Sensor Setup → ZP Adjust

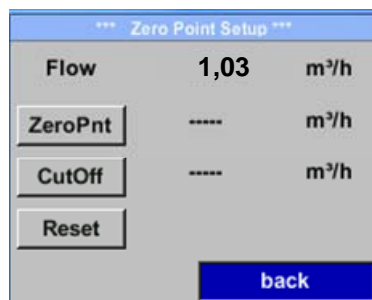

To make changes, first select a menu with button „ $\Delta$ “ and confirm selection by pressing „OK“.

Setup → Sensor Setup → ZP Adjust → ZeroPnt

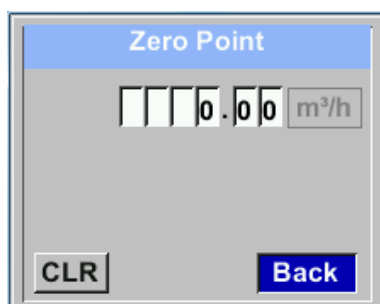

When, without flow, the installed sensor shows already a flow value of  $> 0$  m<sup>3</sup>/h herewith the zero point of the characteristic could be reset.

For an input / change of the value select with the button „ $\Delta$ “ the respective number position and activate it with „OK“.

By pressing „ $\Delta$ “ the position value is incremented by 1. Confirm the input with „OK“ and activate next number position.

Leave menu with button „Back“

Setup → Sensor Setup → ZP Adjust → CutOff

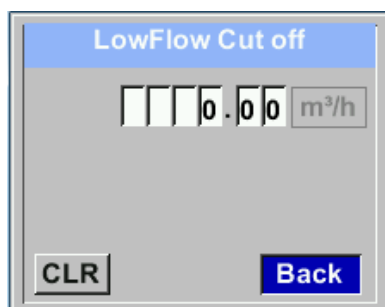

With the low-flow cut off activated, the flow below the defined "LowFlow Cut off" value will be displayed as 0 m<sup>3</sup>/h and not added to the consumption counter.

For an input / change of the value select with the button „ $\Delta$ “ the respective number position and activate it with „OK“.

By pressing „ $\Delta$ “ the position value is incremented by 1. Confirm the input with „OK“ and activate next number position.

Leave menu with button „Back“

Setup → Sensor Setup → ZP Adjust t → Reset



By selection of „Reset“ all settings for „ZeroPnt“ and „CutOff“ are reset.

Menu item to be select with button „ $\Delta$ “ and confirm the reset with „OK“.

Leave menu with button „Back“

### 8.3.2 Modbus Setup

The Flow sensors KEC-2 comes with a Modbus RTU Interface. Before commissioning the sensor the communication parameters

- Modbus ID, Baudrate, Parity und Stop bit

must be set in order to ensure the communication with the Modbus master.

#### Settings → Modbus Setup

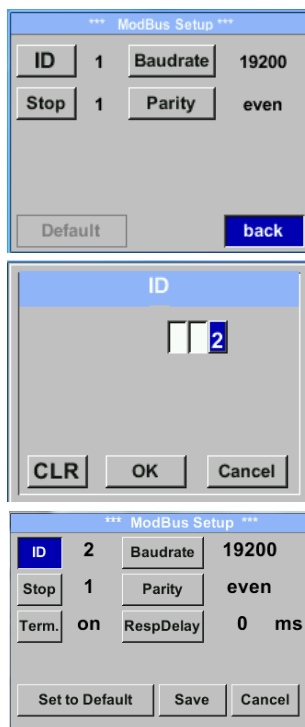

For changes, e.g. the sensor ID, first select by pressing key „△“ the field **“ID”** and then key **“OK”**.

Select the desired position by pressing the **“>”** and select with **“OK”** button.

Change values by pressing the **„△“** values takeover by pressing **“OK”**.

Inputs for remaining information is analog.

Saving the changes by pressing **“Save”**, therefore select it first with key **„△“** and afterwards confirm it with **“OK”**.

To set back to default values please press button **“Set to Default”**

**Default values out of factory:** Modbus ID: 1  
 Baud rate: 19200  
 Stopbit: 1  
 Parity: even

**Remark:** If the sensor placed at the end of the Modbus system a termination is required. Therefore the enclosed 120R resistor is to be connected at Pin 1 and Pin 3 of connector „X2“

**8.3.2.1 Modbus Settings (2001...2005)**

Modbus Register	Register Address	No.of Byte	Data Type	Description	Default Setting	Read Write	Unit /Comment
2001	2000	2	UInt16	Modbus ID	1	R/W	Modbus ID 1...247
2002	2001	2	UInt16	Baudrate	4	R/W	0 = 1200 1 = 2400 2 = 4800 3 = 9600 4 = 19200 5 = 38400
2003	2002	2	UInt16	Parity	1	R/W	0 = none 1 = even 2 = odd
2004	2003	2	UInt16	Number of Stopbits		R/W	0 = 1 Stop Bit 1 = 2 Stop Bit
2005	2004	2	UInt16	Word Order	0xABCD	R/W	0xABCD = Big Endian 0xCDAB = Middle Endian

**8.3.2.2 Values Register (1001 ...1500)**

Modbus Register	Register Address	No.of Byte	Data Type	Description	Default	Read Write	Unit /Comment
1101	1100	4	Float	Flow in m <sup>3</sup> /h		R	
1109	1108	4	Float	Flow in Nm <sup>3</sup> /h		R	
1117	1116	4	Float	Flow in m <sup>3</sup> /min		R	
1125	1124	4	Float	Flow in Nm <sup>3</sup> /min		R	
1133	1132	4	Float	Flow in ltr/h		R	
1141	1140	4	Float	Flow in Nltr/h		R	
1149	1148	4	Float	Flow in ltr/min		R	
1157	1156	4	Float	Flow in Nltr/min		R	
1165	1164	4	Float	Flow in ltr/s		R	
1173	1172	4	Float	Flow in Nltr/s		R	
1181	1180	4	Float	Flow in cfm		R	
1189	1188	4	Float	Flow in Ncfm		R	
1197	1196	4	Float	Flow in kg/h		R	
1205	1204	4	Float	Flow in kg/min		R	
1213	1212	4	Float	Flow in kg/s		R	
1221	1220	4	Float	Flow in kW		R	

## Operation

Modbus Register	Register Address	No.of Byte	Data Type	Description	Default	Read Write	Unit /Comment
1269	1268	4	UInt32	Consumption m <sup>3</sup> before comma	x	R	
1275	1274	4	UInt32	Consumption Nm <sup>3</sup> before comma	x	R	
1281	1280	4	UInt32	Consumption ltr before comma	x	R	
1287	1286	4	UInt32	Consumption Nltr before comma	x	R	
1293	1292	4	UInt32	Consumption cf before comma	x	R	
1299	1298	4	UInt32	Consumption Ncf before comma	x	R	
1305	1304	4	UInt32	Consumption kg before comma	x	R	
1311	1310	4	UInt32	Consumption kWh before comma	x	R	
1347	1346	4	Float	Velocity m/s			
1355	1354	4	Float	Velocity Nm/s			
1363	1362	4	Float	Velocity Ft/min			
1371	1370	4	Float	Velocity NFt/min			
1419	1418	4	Float	GasTemp °C			
1427	1426	4	Float	GasTemp °F			

**Remark:**

- For more additional Modbus values please refer to  
KECXX\_Modbus\_RTU\_Slave\_Installation\_1.00\_EN.doc

### 8.3.3 Pulse /Alarm

Setup → Sensor Setup → Pulse/ Alarm

Relay Mode:	Alarm
Unit	°C
Value	20.0
Hyst.	5.0
Hi-Lim.	OK Cancel

*** Pulse / Alarm ***	
Relay Mode:	Alarm
Unit:	°C
Value	20.0
Hyst.	5.0
Hi-Lim.	OK Cancel

*** Pulse / Alarm ***	
Relay Mode:	Pulse
Unit:	m <sup>3</sup>
Value	0.1
Polarity	pos.
Pls per second at max Speed: 0	
Back	

The galvanically isolated output can be defined as pulse- or alarm output. Selection of field „**Relay Mode**“ with key „**Δ**“ and change modus by pressing key „**OK**“.

For alarm output following units could be chosen: kg/min, cfm, ltr/s, m<sup>3</sup>/h, m/s, °F, °C and kg/s.

„**Value**“ defines the Alarm value, „**Hyst.**“ defines the desired hysteresis and with „**Hi-Lim**“ or „**Lo-Lim**“ the alarm settings when the alarm is activated

Hi-Lim: Value over limit  
Lo-Lim: Value under limit

For the pulse output following units could be chosen: kg, cf, ltr and m<sup>3</sup>.

The pulse value definition to be done in menu „**Value**“ (0.1, 1, 10, 100).

With „**Polarity**“ the switching state could be defined.

Pos. = 0 → 1 neg. 1 → 0

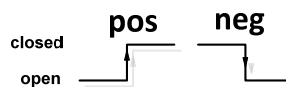

#### 8.3.3.1 Pulse output

The maximum frequency for pulse output is 50 pulses per second (50Hz).

The Pulse output is delayed by 1 second.

Pulse value	[m <sup>3</sup> /h]	[m <sup>3</sup> /min]	[l/min]
0.1 ltr / Pulse	1,8	0,3	300
1ltr / Pulse	18	3	3000
0.1m <sup>3</sup> / Pulse	18000	300	300000
1 m <sup>3</sup> / Pulse	180000	3000	3000000

Table 1 Maximum flow for pulse output

Entering pulse values that are not allow a presentation to the full scale value, are not allowed. Entries are discarded and error message displayed.

### 8.3.4 User Setup

Settings → UserSetup

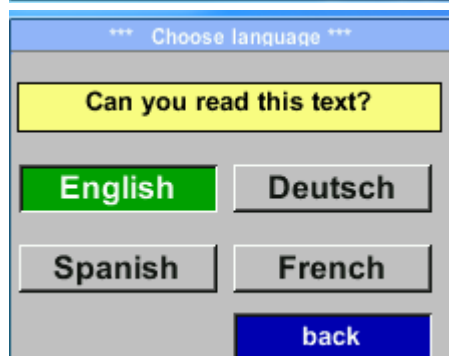
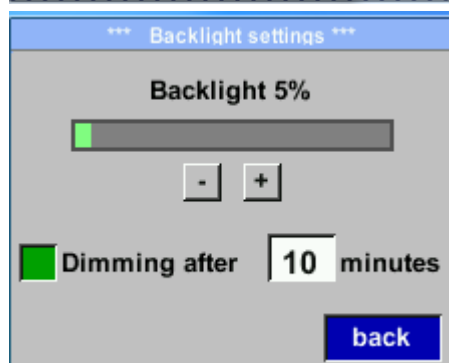
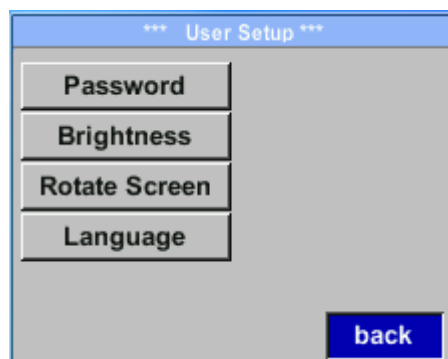

To make changes, first select a menu with button „**Δ**“ and confirm selection by pressing „**OK**“ .

It is possible to define a password. The required password length is 4 digits. Please select with button „**Δ**“ a figure and confirm it with „**OK**“ .Repeat this 4 times.

With „**<**“ the last figure could be deleted.

Password input have to be inserted twice.

Confirmation of input/password by pressing „**OK**“.

With „**Brightness**“ it is possible to adjust the backlight / display brightness.

By activation „**Dimming after**“ and entering a time a display dimming could be set.

With „**Rotate Screen**“ the display information could be rotated by 180°.

Currently 4 languages have been implemented and could be selected with button „**Δ**“ .

Change of language by confirming with „**OK**“ . Leaving the menu with button „**back**“.



### 8.3.5 Advanced

*Settings → Advanced*

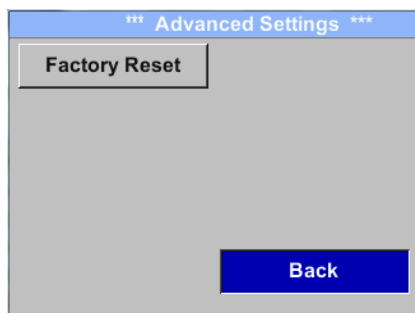

By pressing „**Factory Reset**“ the sensor is set back to the factory settings.

### 8.3.6 4 -20mA

Settings → 4-20mA

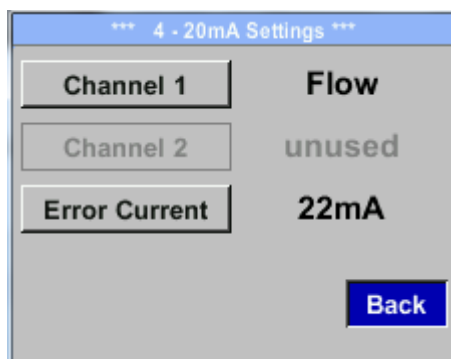

To make changes, first select a menu with button „ $\Delta$ “ and confirm selection by pressing „OK“.

Settings → 4-20mA → Channel 1

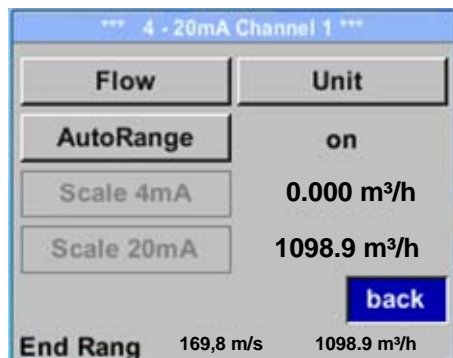

The 4-20 mA Analogue output of the Sensor KEC can be individually adjusted.

It is possible to assign following values „Temperature“, „Velocity“ und „Flow“ to the channel CH 1.

To make changes, first select the value item with button „ $\Delta$ “ .and confirm  
Moving between the different measurements values or to deactivate the 4-20mA with setting to „unused“ by pressing „OK“.

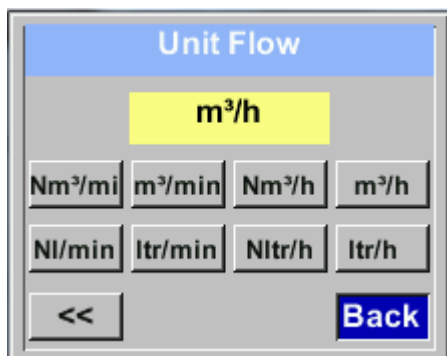

To the selected measurement value a corresponding / appropriate unit needs to be defined. Select „Unit“ with „ $\Delta$ “ and open menu with „OK“. Select required unit with „ $\Delta$ “ and take over by pressing „OK“.

Here e.g. for the measurement value Flow, procedure for the other measurements values is analog.

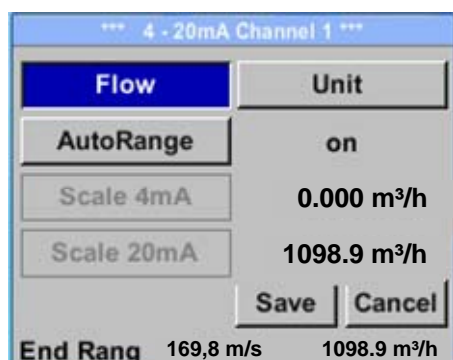

For saving the changes done press button „Save“ to discard the changes press button „Cancel“.

Leaving the menu with „Back“.

Settings → 4-20mA → Channel 1 → AutoRange

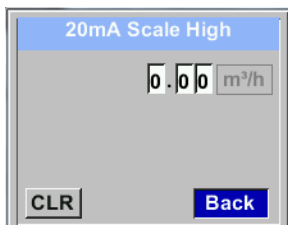
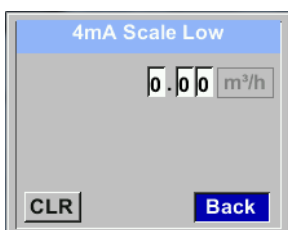
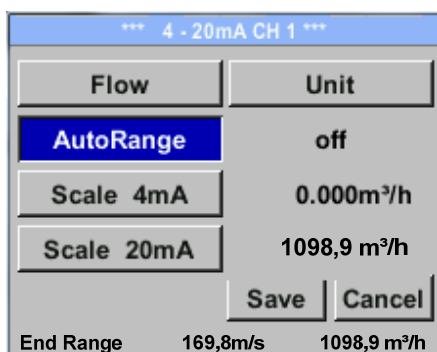

The scaling of the 4-20mA channel can be done automatically "Auto Range = on" or manual "AutoRange = off" .

With button „ $\Delta$ “ select the menu item „AutoRange“ select with „OK“ the desired scaling method. (Automatically or manually)

In case of **AutoRange = off** with „Scale 4mA“ and „Scale 20mA“ the scale ranges needs to be defined.

Select with button „ $\Delta$ “ the item „Scale 4mA“ or „Scale 20mA“ and confirm with „OK“ .

Input of the scaling values will be analogous as described before for value settings.

Using „CLR“ clears up the complete settings at once.

For „Auto on“ , the max. scaling is calculated based on the inner tube diameter, max. measurement range and the reference conditions settings.

Take over of the inputs with „Save“ and leaving the menu with „Back“.

Settings → 4-20mA → Error Current

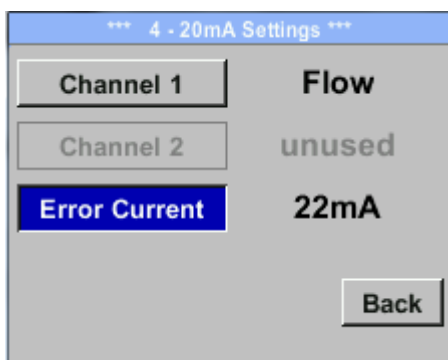

This determines what is output in case of an error at the analog output.

- 2 mA Sensor error / System error
- 22 mA Sensor error / System error
- None Output according Namur (3.8mA – 20.5 mA)  
 < 4mA to 3.8 mA Measuring range under range  
 >20mA to 20.5 mA Measuring range exceeding

To make changes first select a menu item "Current Error" with button „ $\Delta$ “ and then select by pressing the „OK“ the desired mode

For saving the changes done press button „Save“ to discard the changes press button „Cancel“.

Leaving the menu with „Back“.

### 8.3.7 KEC-2 Info

Setup → Sensor Setup → Info



Here you get a brief description of the sensor data incl. the calibration data.

Under *Details*, you are able to see in addition the calibration conditions.

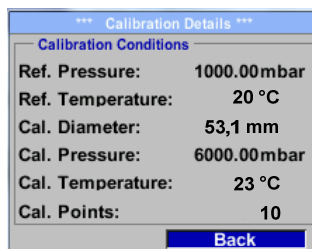

## 8.4 MBus

### 8.4.1 Default Settings communication

Primary Adress*:	1
ID:	Serialnumber of Sensor
Baud rate*:	2400
Medium*:	depending on medium (Gas or Compressed Air)

Both addresses, Primary address and ID, could be automatic searched in the M-Bus system.

### 8.4.2 Default values transmitted

Value 1 with [Unit]*:	Consumption [m³]
Value 2 with [Unit]*:	Flow [m³/h]
Value 3 with [Unit]*:	Gas temperature [°C]

\*All Values could be changed / preset in production or with Kobold Service software

**9 Supplementary Documentation**

- Supplementary Documentation for Ex-Version (in preparation)

---

## 10 EU Declaration of Conformance

We, KOBOLD Messring GmbH, Hofheim-Ts, Germany, declare under our sole responsibility that the product:

**Thermal Energy Flowmeter for gases**

**Model: KEC-2**

to which this declaration relates is in conformity with the standards noted below:

**EN 55011:2011** Industrial, scientific and medical equipment - Radio-frequency disturbance characteristics - Limits and methods of measurement

**EN 61326-1:2013** Electrical equipment for measurement, control and laboratory use - EMC requirements - Part 1: General requirements

Also the following EU guidelines are fulfilled:

**2014/30/EU**  
**2011/65/EU**

**EMC Directive**  
**RoHS**

Hofheim, 07. Febr. 2017



H. Peters  
General Manager



M. Wenzel  
Proxy Holder

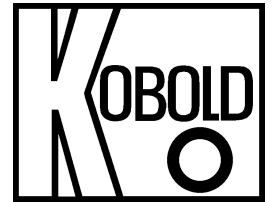

**Installation and Operating Instructions**  
**for**  
**Service Software**

**Model: KEC-Soft**

Table of contents

- 1 First steps ..... 3
  - 1.1 Installation of the PC Service Software Flow sensor ..... 3
  - 1.2 Connecting the device to the "Service Software Adapter" ..... 3
  - 1.3 Connecting the flow meter to the computer ..... 3
  - 1.4 Connecting with Modbus RTU..... 4
- 2 Description of the software..... 5
  - 2.1 Device Info..... 6
    - 2.1.1 Device Info "General" ..... 6
    - 2.1.2 Device Info "Actual Values" ..... 7
    - 2.1.3 Device info "Firmware Update" ..... 8
    - 2.1.4 Update Language..... 8
    - 2.1.5 XML - Settings..... 8
  - 2.2 Sensor Settings ..... 9
    - 2.2.1 General ..... 9
    - 2.2.2 Gas..... 9
    - 2.2.3 Units ..... 10
    - Save the new unit using the "Set" button. .... 10
    - 2.2.4 Parameter..... 10
    - 2.2.5 Zero Point Adjustment ..... 11
  - 2.3 Average Values ..... 12
    - 2.3.1 Average Time Span / Clear Min, Max..... 12
  - 2.4 Settings 4 - 20 mA..... 13
    - 2.4.1 4 - 20 mA (analogue output settings)..... 13
  - 2.5 Relais ..... 14
    - 2.5.1 Pulse settings..... 14
    - 2.5.2 Alarm settings..... 14
  - 2.6 Interface Settings ..... 15
    - 2.6.1 Modbus Settings..... 15
    - 2.6.2 Display Settings ..... 15
  - 2.7 Expert Settings..... 16
    - 2.7.1 Calibration settings..... 16
    - 2.7.2 Parameter..... 16
  - 2.8 MBus Settings (optional) ..... 17
    - 2.8.1 Interface settings..... 17
    - 2.8.1 Values settings..... 18



## 1 First steps

### 1.1 Installation of the PC Service Software Flow sensor

Please install the "PC - Service Software Flow Sensors" by starting (double click) the Setup File, "setup Service Soft Flow Sensor 1.0.0.xx"

For latest version, please contact the sensor manufacturer.

### 1.2 Connecting the device to the "Service Software Adapter"

- Please connect the "Service Software Adapter" with the power grid.
- Now connect the "Service Software Adapter" with plug **A** of the flow meter.
- Connect the "Service Software Adapter" with the USB port of your computer.

### 1.3 Connecting the flow meter to the computer

Please open the latest version of the "PC Service Software Flow Sensors". Be sure, that the control window "CA5xx" is activated. Now choose the "COM-Port" and click "Connect".

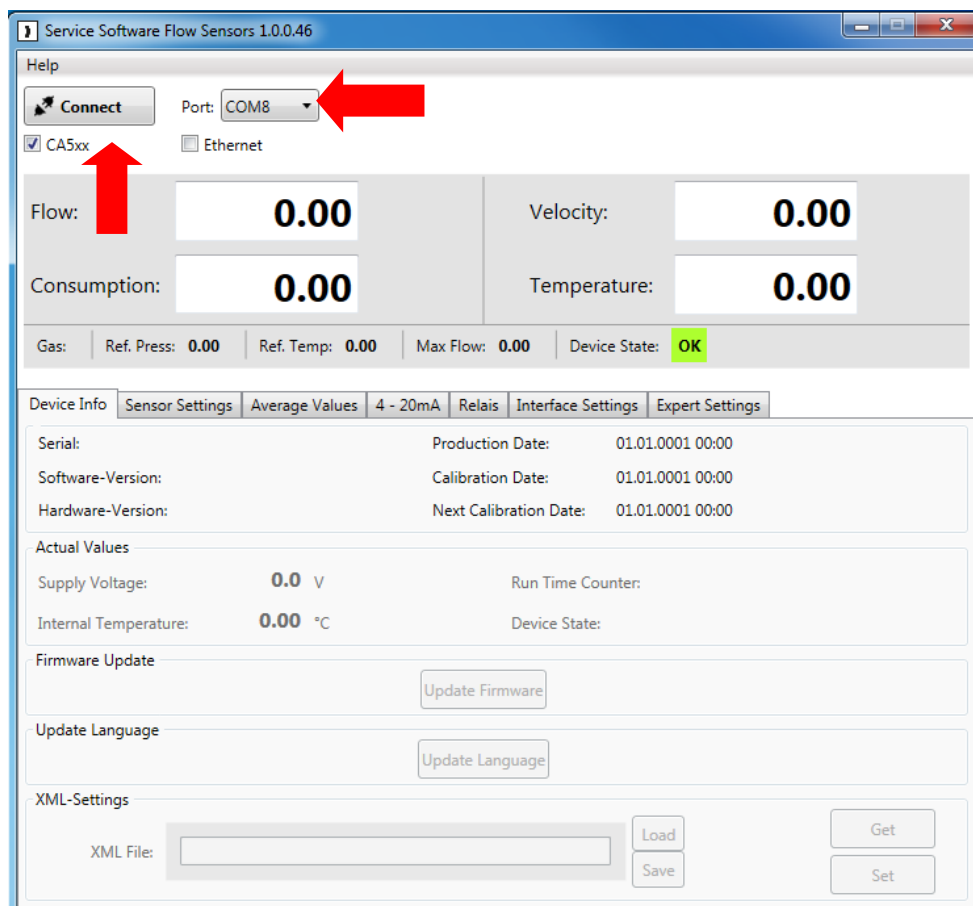

## 1.4 Connecting with Modbus RTU

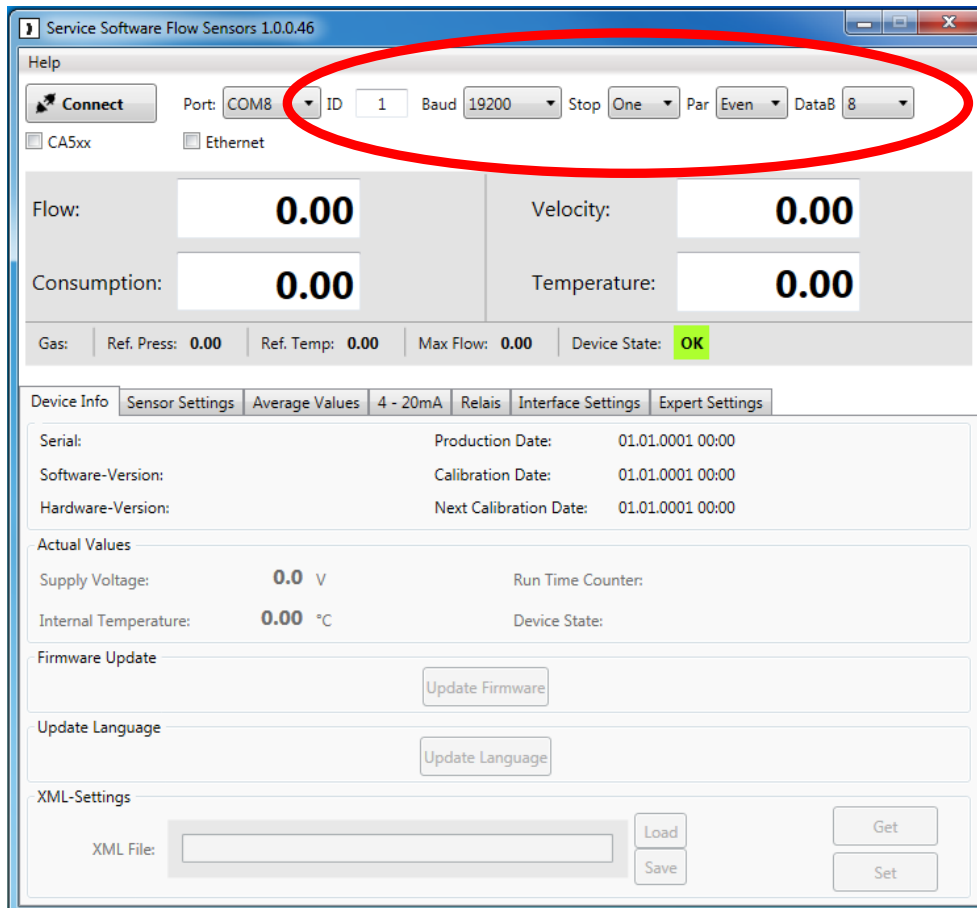

If you don't have the "PC-Service Software Adapter", but your own Modbus converter, please deactivate the control window "CA5xx".

Enter the specific values of the flow meter in the red marked area above.

- ID: 1
- Baud: 19200
- Stop: 1
- Parity: even
- Databits: 8

Please have also a look at - 2.6 Interface Settings

## 2 Description of the software

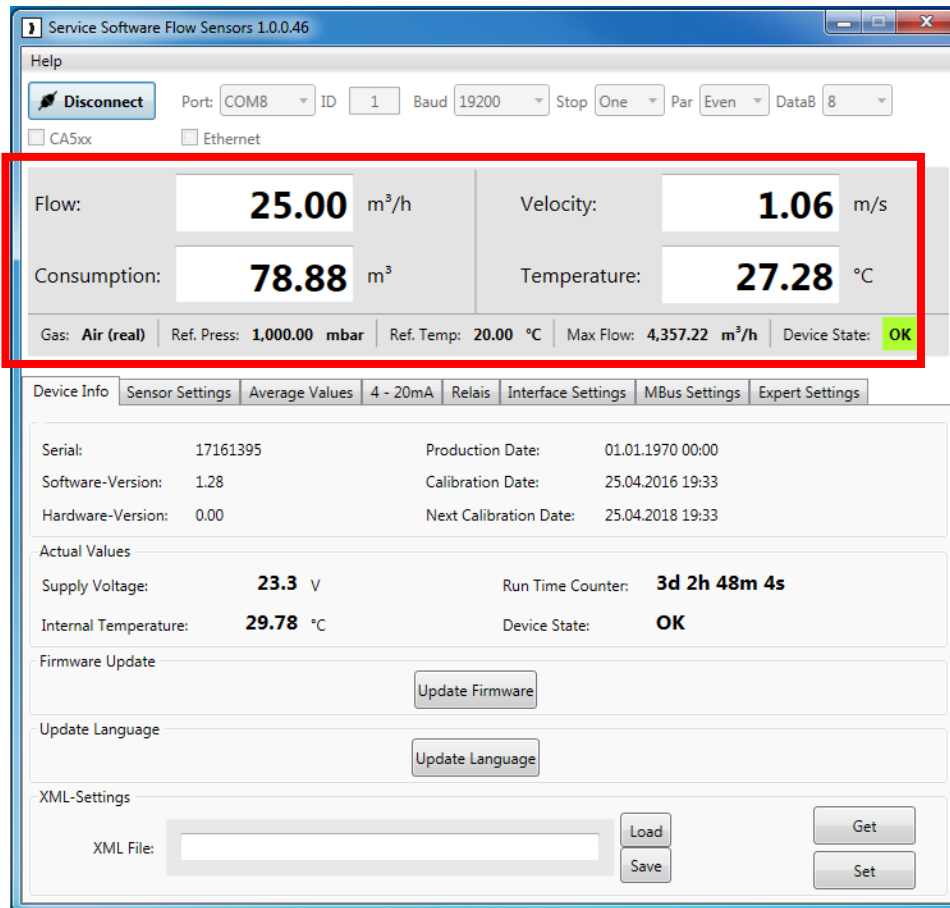

The upper part of the window shows the current measurements. In this case the calculation of "Flow" and "Velocity" are based on the values "Reference pressure" and "Reference temperature".

- Flow: Current rate of flow volume
- Consumption: The consumption meter adds the whole flow volume since the beginning of the measurement (**Please have also a look at 2.2 Sensor Settings - General - Consumption**)
- Velocity: Current flow velocity
- Temperature: Current gas temperature
- Gas: Current kind of gas (Sensor Settings --> Gas)
- Ref. Press.: Current set reference pressure (Sensor Settings --> Parameter)
- Ref. Temp.: Current set reference temperature (Sensor Settings --> Parameter)
- Max. Flow: The maximum flow rate which is possible with the actual settings of reference pressure, reference temperature and kind of gas.
- Device State: The "Device State" will be green, if the device is operable. The state will switch from green (OK) to red (ERROR), if the device is not proper connected.

Device State: **Error**    Device State: **OK**

## 2.1 Device Info

The tab "Device Info" shows different information's about the flow meter.

### 2.1.1 Device Info "General"

The menu item "Device Info" shows an overview about different specific information's. For example, the serial number, HW- & SW-Version, the production and calibration dates of the connected flow meter etc.

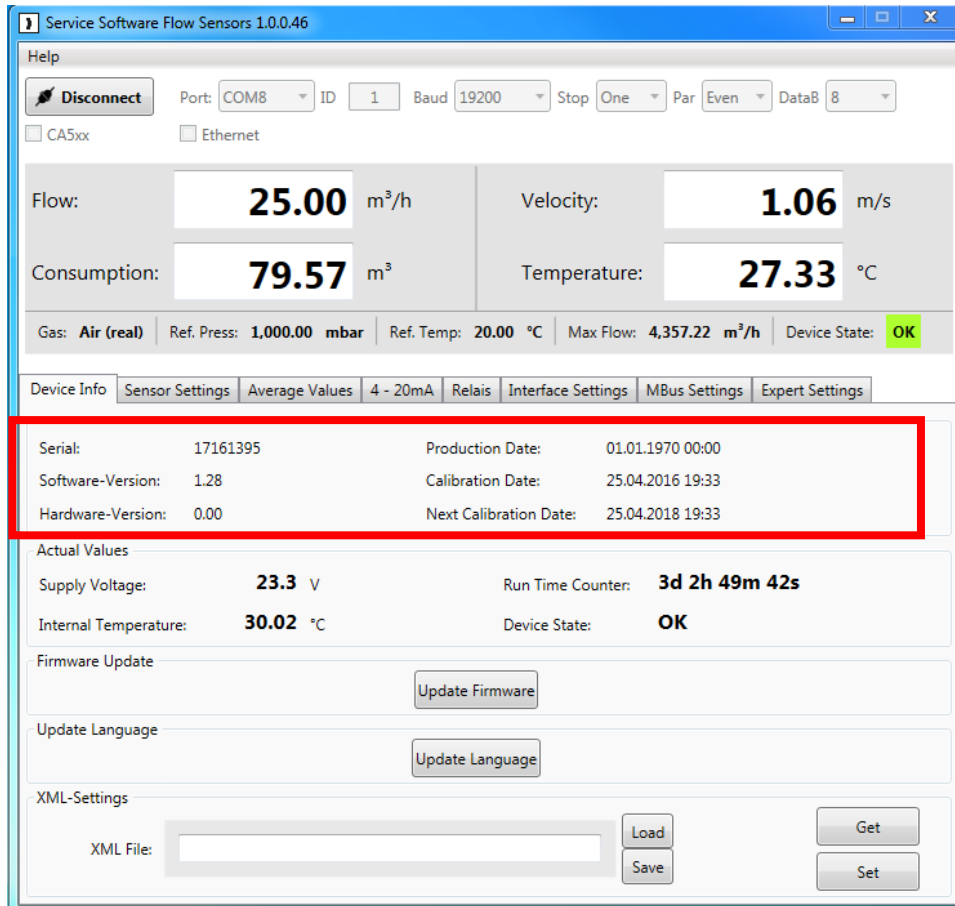

## KEC-Soft

### 2.1.2 Device Info "Actual Values"

The screenshot shows the 'Service Software Flow Sensors 1.0.0.46' application window. At the top, there are connection settings: Port: COM8, ID: 1, Baud: 19200, Stop: One, Par: Even, DataB: 8. Below this are checkboxes for CA5xx and Ethernet. The main display area shows four large numerical values: Flow: 25.00 m³/h, Velocity: 1.06 m/s, Consumption: 79.57 m³, and Temperature: 27.33 °C. Below these are smaller values: Gas: Air (real), Ref. Press: 1,000.00 mbar, Ref. Temp: 20.00 °C, Max Flow: 4,357.22 m³/h, and Device State: OK. A tabbed interface below shows 'Device Info' selected, with sub-tabs for Sensor Settings, Average Values, 4 - 20mA, Relais, Interface Settings, MBus Settings, and Expert Settings. The 'Actual Values' section is highlighted with a red border and contains: Supply Voltage: 23.3 V, Run Time Counter: 3d 2h 49m 42s, Internal Temperature: 30.02 °C, and Device State: OK. Below this are sections for Firmware Update (with an Update Firmware button), Update Language (with an Update Language button), and XML-Settings (with an XML File input field, Load, Save, Get, and Set buttons).

The section "Actual Values" shows:

- Supply Voltage: The current supply voltage of the connected flow meter
- Internal Temperature: The current internal temperature of the connected flow meter
- Run Time Counter: Shows the total time of operation (Day:Hour:Minute:Second)
- Device State: please have a look at section **2 Description of the Software**

## KEC-Soft

### 2.1.3 Device info "Firmware Update"

At this point you can update your device with the latest software version

First you have to request the "update procedure" by pressing the button "Update Firmware"

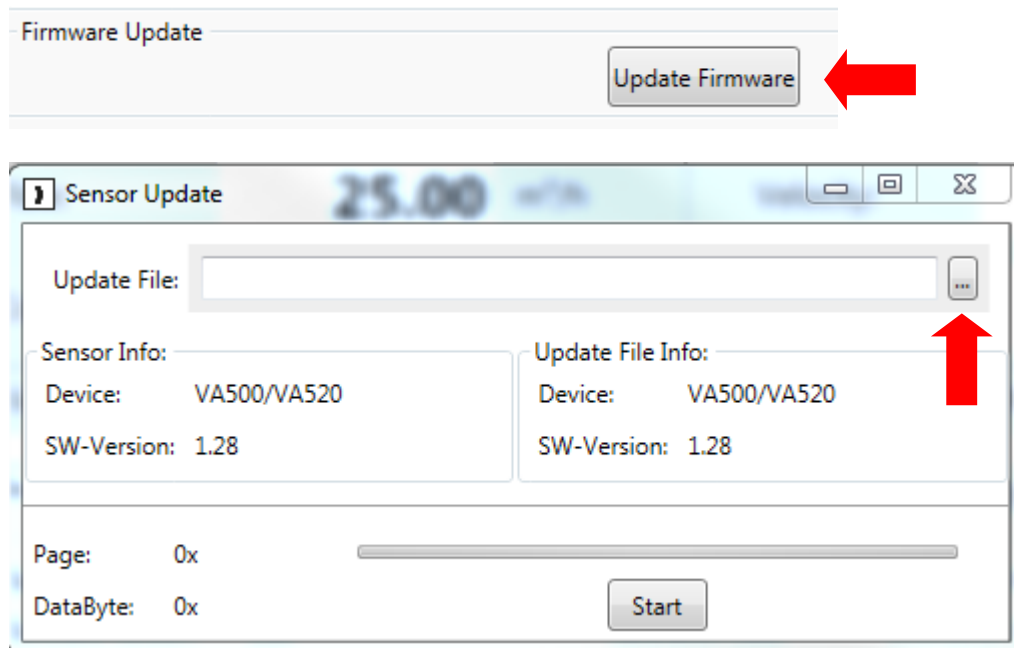

In the upcoming popup, you have to select the new software (file), selection by pressing the path icon see red arrow. To start the update please press "Start" button.

For the latest software version, please contact your sensor manufacturer.

### 2.1.4 Update Language

You can update your sensor with different language files at "Update Language".

**For more information, please ask your manufacturer.**

### 2.1.5 XML - Settings

The sensor settings could be stored in a XML file on a Harddisc, USB etc. So you can restore the sensor settings on the sensor itself or more you can also transfer sensor settings to different sensors.

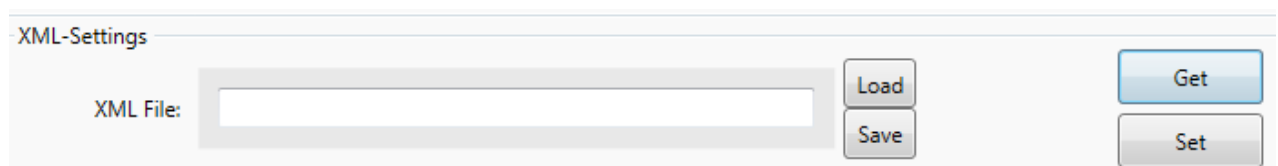

Load: Load XML-File l from Harddisc, USB etc.

Save: store XML-File to Harddisc, USB etc.

Get: Load Settings from sensor for storing as XML-File.

Set: Store Settings from XML-File in Sensor.

## 2.2 Sensor Settings

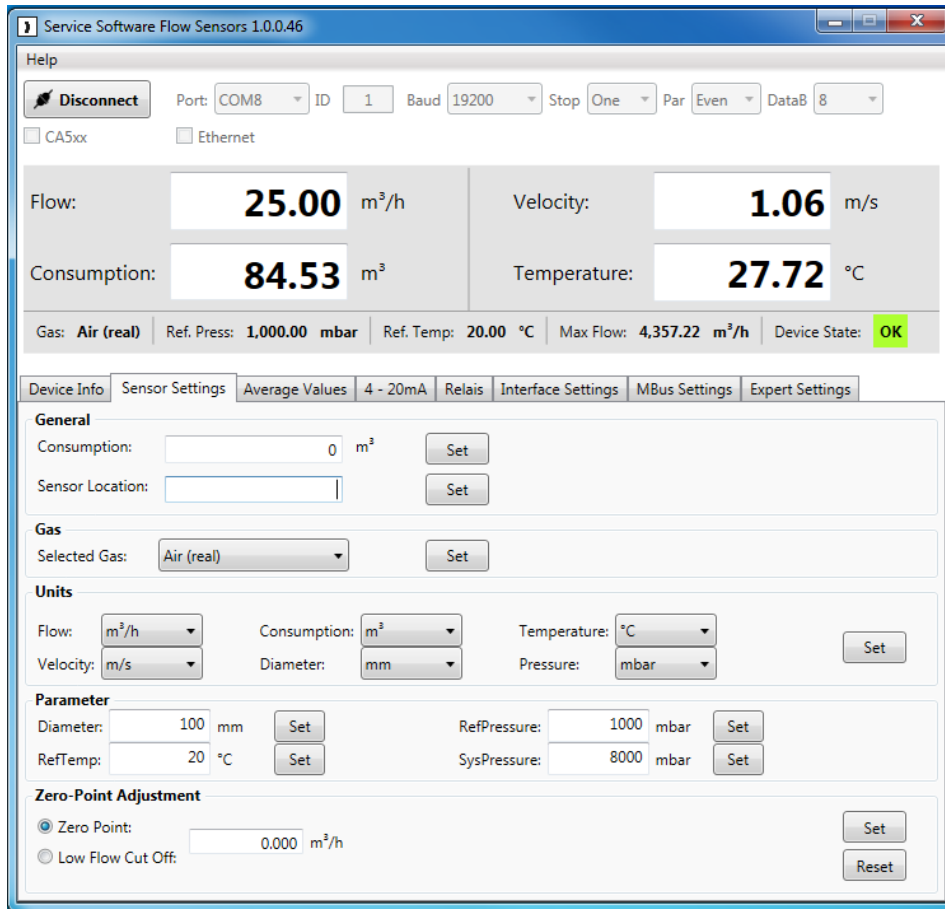

### 2.2.1 General

- Consumption: Here you are able to preset the value, e.g. by replacing another sensor. Value to be entered into the field and transferred to sensor by pressing the "Set" button.
- Sensor Location: Enter up to 15 letters. Text to be entered into the field and transferred to sensor by pressing the "Set" button.

### 2.2.2 Gas

At "Selected Gas" you can choose between different preprogrammed gas types.

If it is a **real gas calibration**, there is the addition "(Real)" behind the name of the gas.

The measuring values will be calculated based on the values of air, if there is no addition.

### 2.2.3 Units

All units are predefined during production, here and as well at the sensor itself; you have the possibility to change it. Possible units are selectable in the popup menu.

For accessing, please press the “arrow done” symbol of the respective unit.

Example for unit of flow:

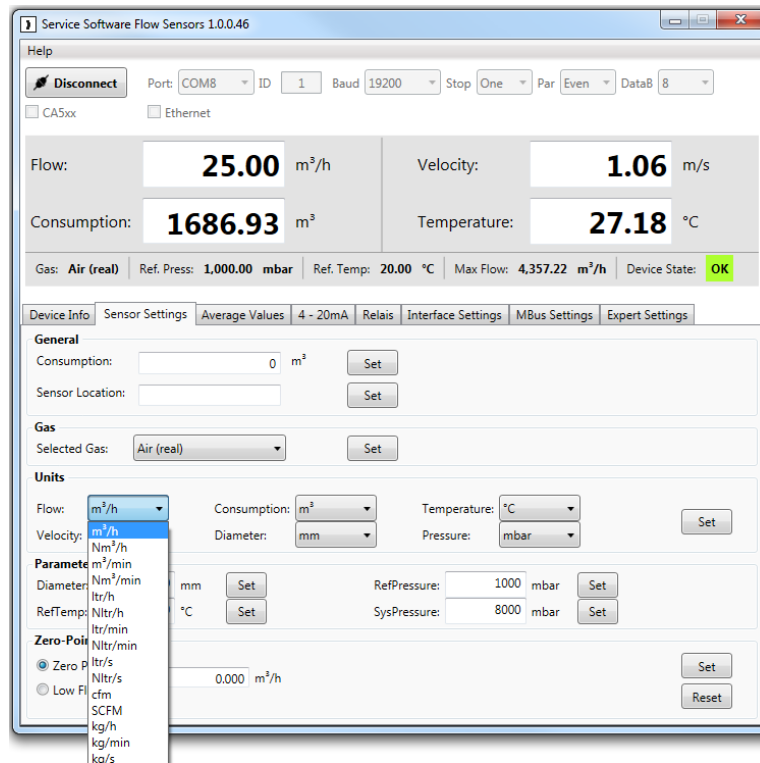

Save the new unit using the "Set" button.

### 2.2.4 Parameter

At the point "Parameter" you can change reference temperature, reference pressure and also enter your system pressure.

To get correct measurement results the correct pipe diameter is required.

In case you have an immersion sensor, it is possible to enter your pipe diameter at "Diameter". Procedure is the identical as above, insert value in corresponding field and transfer it to sensor by pressing the “Set” button.

#### Remark!

**For sensors with integrated measurement sections, diameter is not changeable.**



### 2.2.5 Zero Point Adjustment

It is possible to enter a value that will be used either for **zero point calibration** or **low flow cut off**.

- Your entered value will be used as zero point, if you choose "Zero Point". The sensor will start counting at this point. This adjustment is helpful if there is no flow in the pipe, but the sensor shows some.  
**For example:** Although there is 0,00 m<sup>3</sup>/h flow in the pipe the flow meter shows 0,08 m<sup>3</sup>/h. Now you can raise up your zero point to 0,08 m<sup>3</sup>/h, the flow meter will show now 0,00 m<sup>3</sup>/h.
- Your entered value will be used as cut off value, if you choose "Low Flow Cut Off". All measuring values below this value won't be shown at the display of the KEC. The values below your entered value also won't be calculated to the consumption meter. Even the 4 - 20 mA output will be set to zero (4 mA) and there won't be impulses.

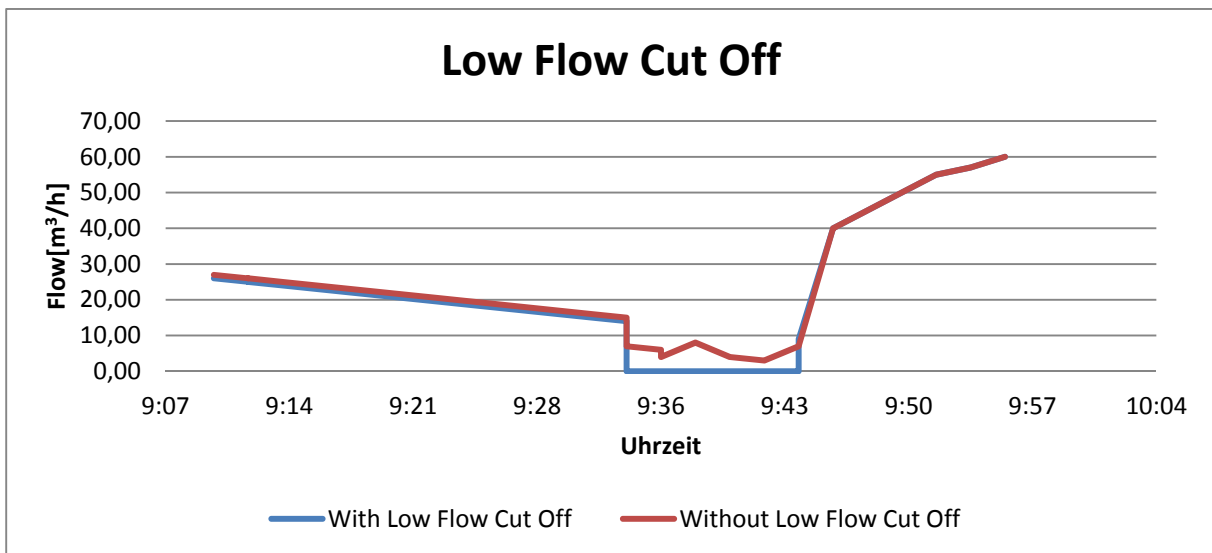

**For Example:**

Despite the closed ball valve, 8 m<sup>3</sup> / h is still measured in the supply line

The customer set the low flow cut off at 10 m<sup>3</sup>/h.

The display and the impulse outlet now show zero also the 4-20 mA outlet shows zero (4 mA).

### 2.3 Average Values

In the tab "Average Values" the minimum, maximum and average values are displayed, in addition the settings for the reference time could be adapted.

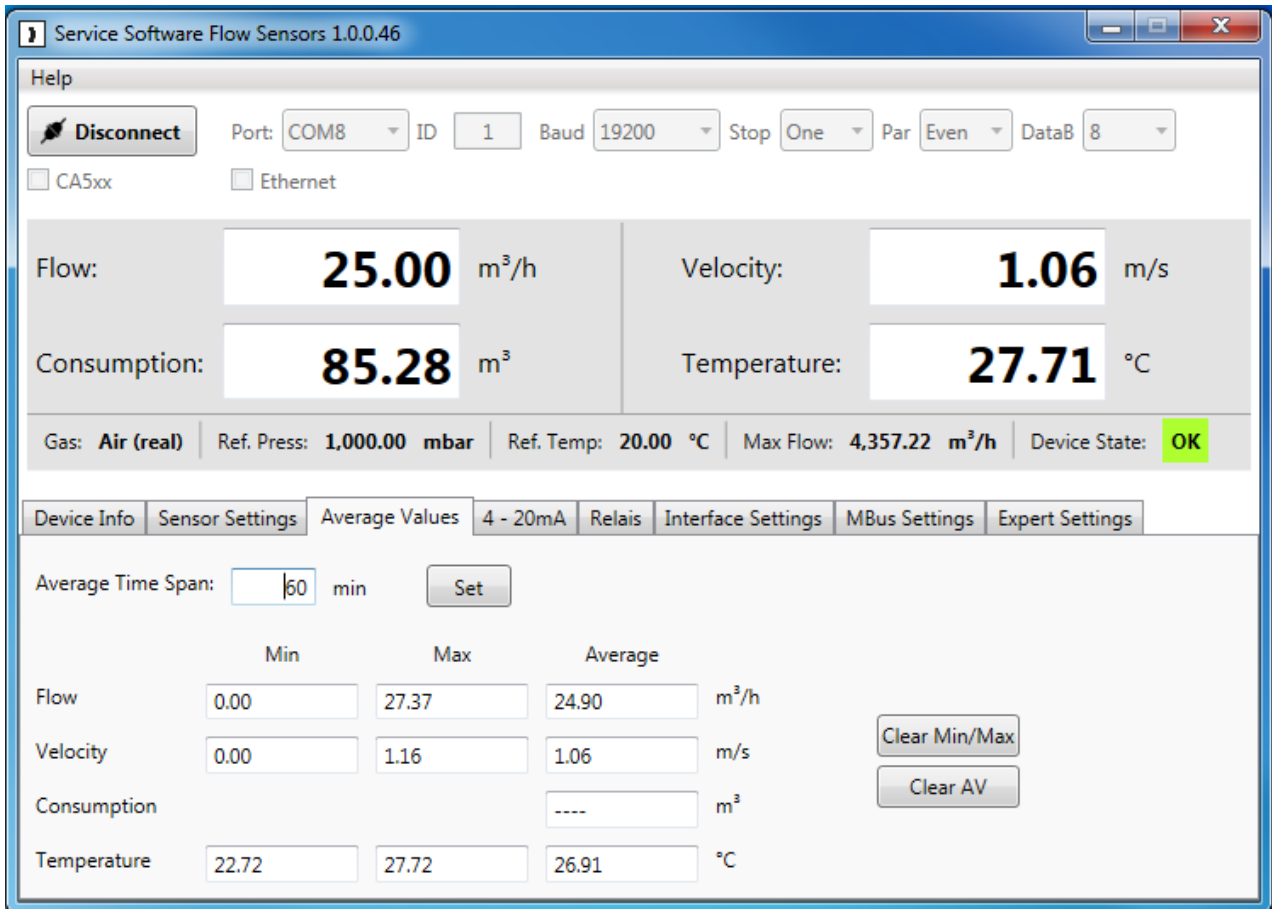

#### 2.3.1 Average Time Span / Clear Min, Max

The average time span can be entered at this tab. (Minimal: 1 minute; Maximum: 1440 minutes)

With the buttons "Clear Min/Max" and "Clear AV" it is possible to reset the minimal/maximal values and the average values (Flow, Velocity, Consumption, Temperature).

## 2.4 Settings 4 - 20 mA

The Flow-sensor has one 4 - 20 mA analogue output(s), optional 2x 4...20mA analogue outputs. The outputs are individual adjustable.

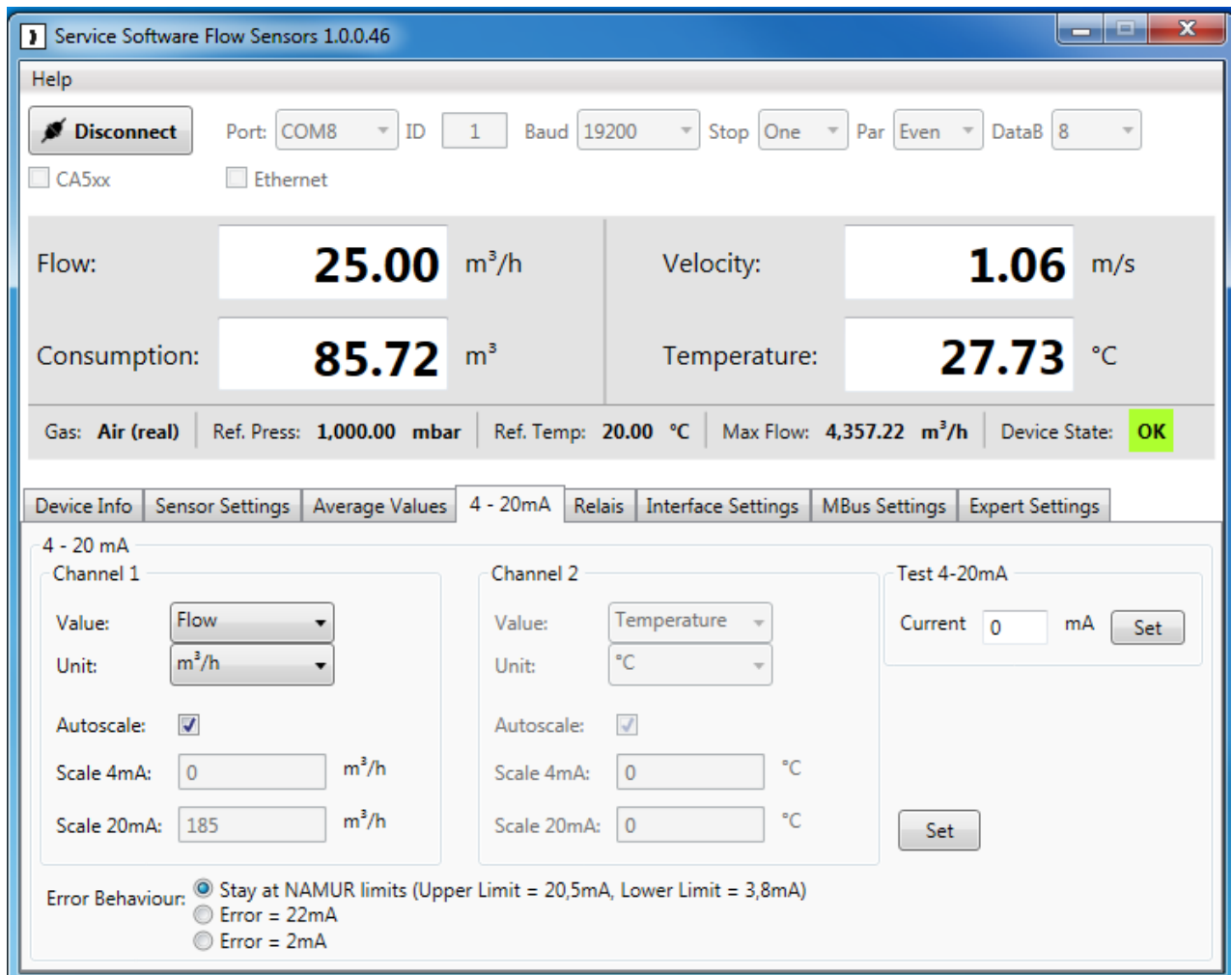

### 2.4.1 4 - 20 mA (analogue output settings)

You can enter your desired measuring outputs at "Value". Please enter also the correct units for your needs at "Unit".

Your upper limit value will be the measuring limit of the value that was set at "Value", if you choose "Autoscale".

Please insert your specific limits at "Scale 4mA/Scale 20mA" if you want to scale manually.

You can also enter adjustments for "Channel 2", if the sensor is equipped with 2 channels.

It is possible to set different scenarios in case of an error at "Error Behaviour".

- Stay at NAMUR limits: Depending on the measuring value the output will be set 3,8 mA or 20,5 mA.
- Error = 22 mA: The output current will be set to 22 mA.
- Error = 2 mA: The output current will be set to 2 mA.

## 2.5 Relais

The galvanic isolated output can set as pulse- or alarm output.

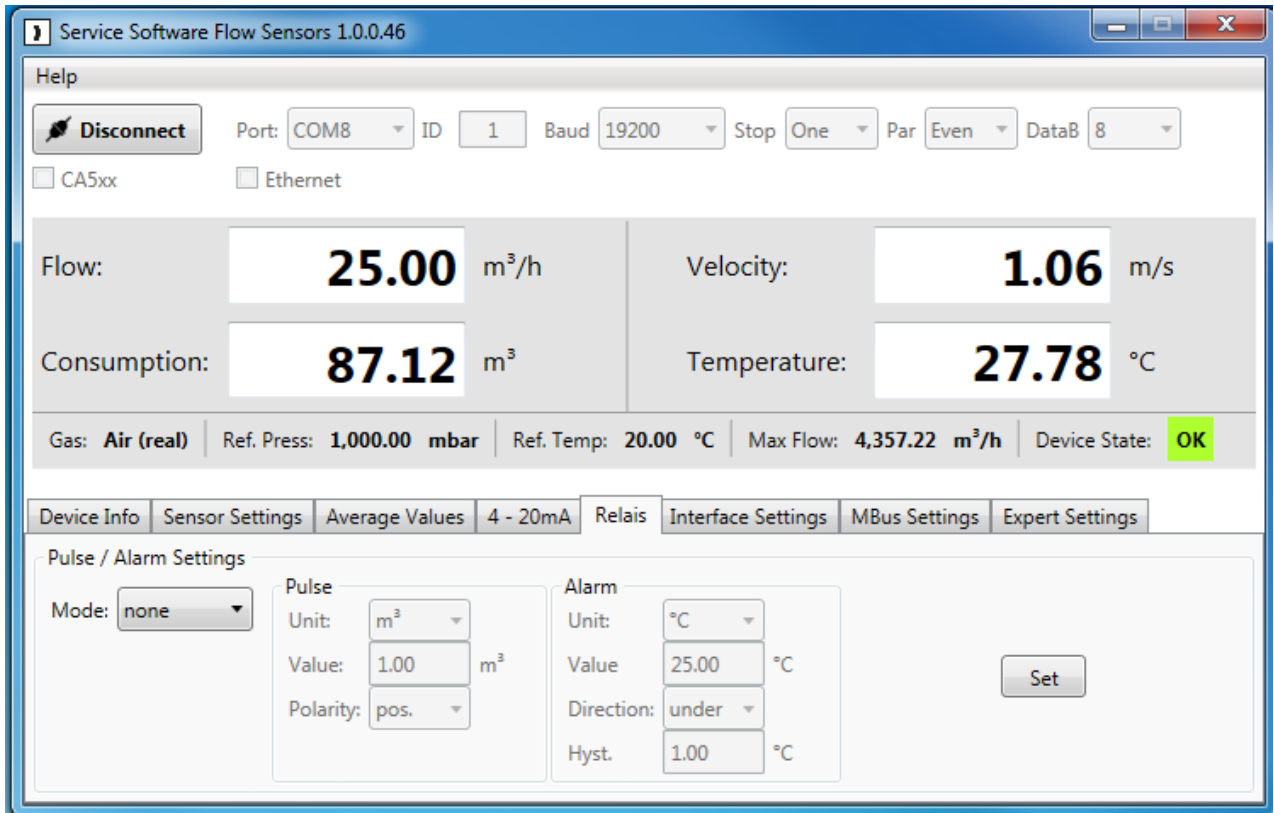

### 2.5.1 Pulse settings

Please select "Pulse" with the button "Mode". You can now specify the desired settings for the pulse output. Choose a unit for your pulse output at "Unit". You can change the pulse-value at "Value" and the polarity at "Polarity" (pos. 0-->1; neg. 1-->0)

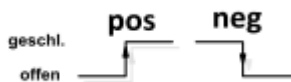

### 2.5.2 Alarm settings

Please select "Alarm" with the button "Mode". Select now your desired unit for the alarm. Specify the alarm value. With "Direction" you can choose if you want to trigger the alarm whether by passing the entered value or by falling below this value. You can also enter a value for the hysteresis at "Hyst.".

## 2.6 Interface Settings

The flow meter owns a RS485 (Modbus RTU) interface. You have to specify the different interface settings before a communication with your Modbus master device and the flow meter is possible.

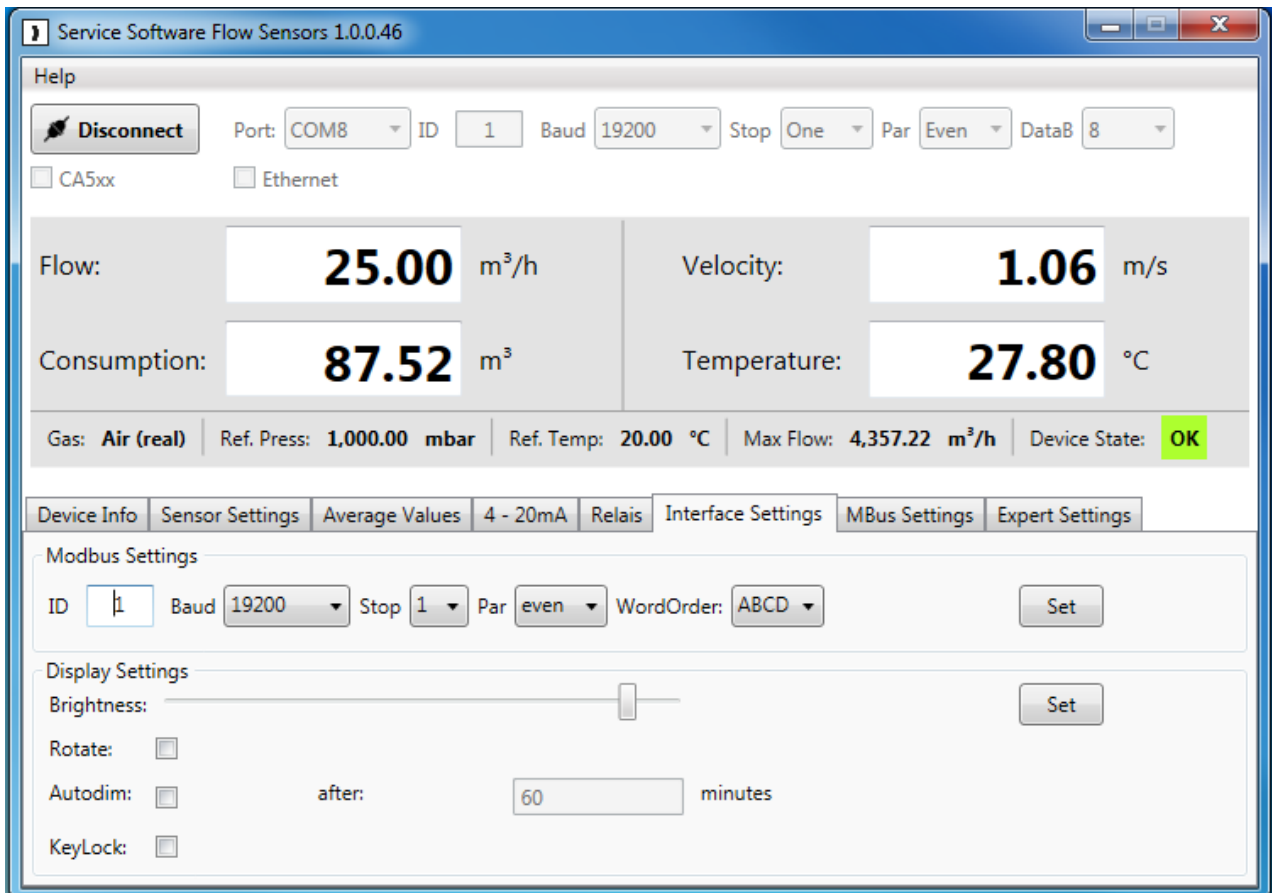

### 2.6.1 Modbus Settings

Factory Settings:

- Modbus ID: 1
- Baud: 19200
- Stop: 1
- Par: even
- Data: 8
- WordOrder ABCD(Little Endian) or CDAB (Middle Endian)

Sensor and master device settings have to correspond.

### 2.6.2 Display Settings

You can change the display brightness with moving the regulator. Confirm your adjustment with pressing the "Set"-button.

You can also rotate the display by 180 degrees, if you activate the control window "Rotate"

## 2.7 Expert Settings

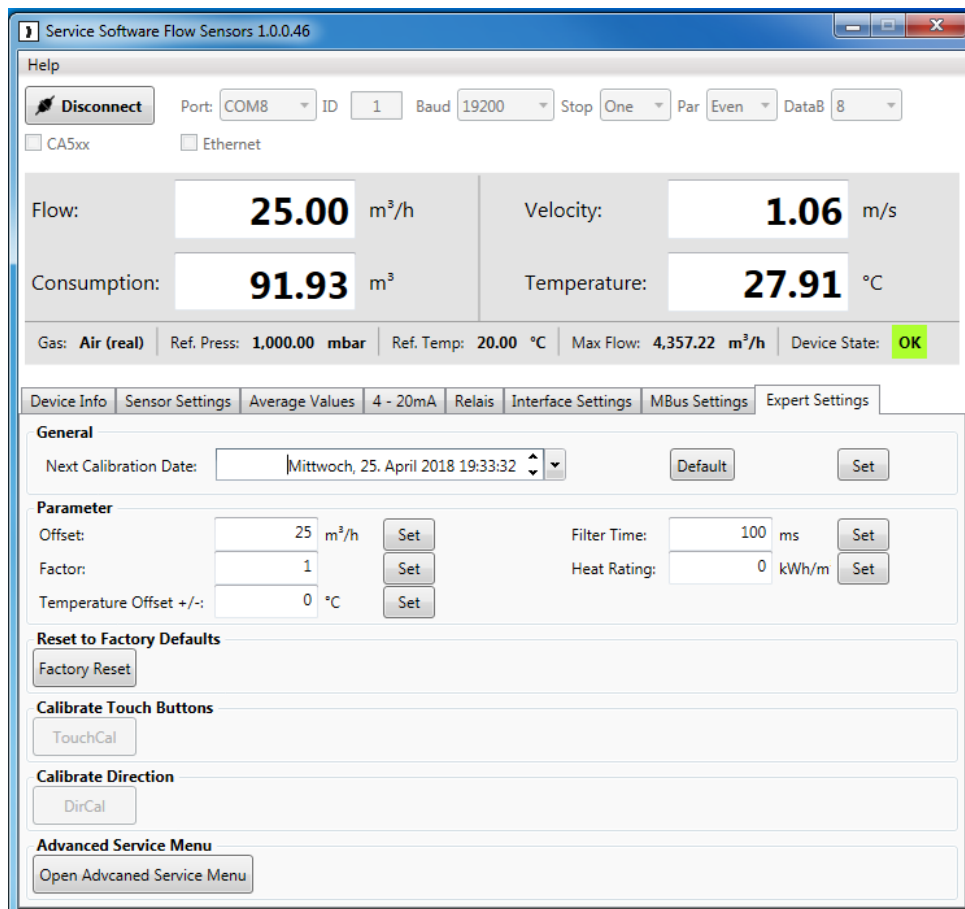

### 2.7.1 Calibration settings

The next calibration date can be set under "General".

A regular calibration of the sensor is recommended, based on the setting of "Next Calibration Date" a message will be displayed.

Next calibration date can be defined by the integrated calendar. Access by means of the symbol "arrow down arrow"

With "Default", the recommended next calibration of 1 year would be set automatically.

### 2.7.2 Parameter

There are different parameters to influence / modify the measurement.

**It is not recommended to change parameters without contacting the sensor manufacturer.**

- Offset: The measuring value will be changed by the entered value
- Factor: The measuring value will be multiplied by the entered value
- Temp. Offset: Correction of temperature
- Filter Time: It is possible to enter a filter time to change the attenuation (0-10000 [ms])
- Heat Rating: Enter a calorific value for flammable gases (0°C; 1013,25 mbar)

### 2.7.3 Factory reset

To reset the sensor to factory settings please press "Factory Reset".

## 2.8 MBus Settings (optional)

### Remark!

This menu is displayed only in case the sensor is equipped with the option “ MBUS”

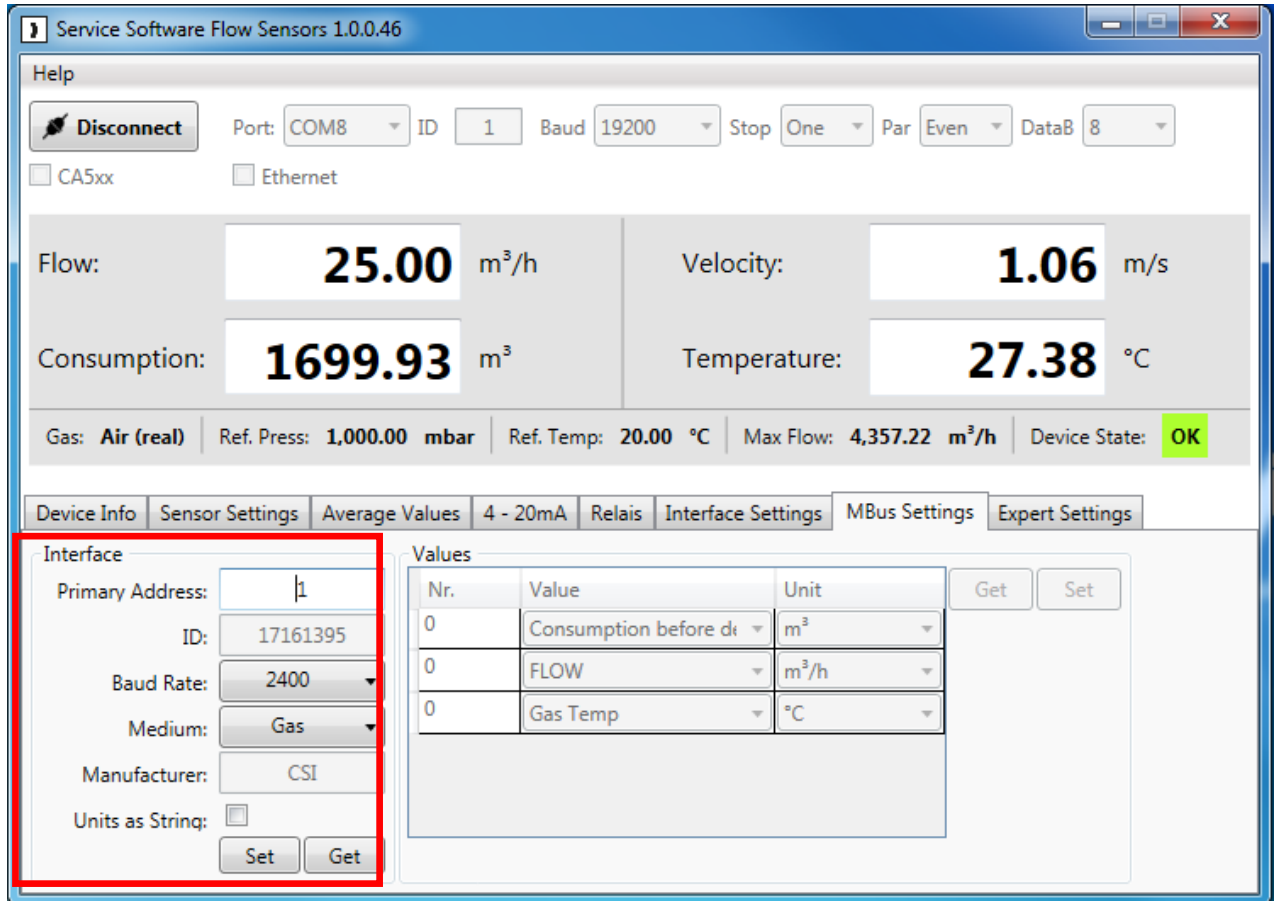

### 2.8.1 Interface settings

With “Get” you are receiving the interface parameter from the sensor.

With “Set” you are transferring / changing the parameters.

Primary Adress: could be set individual, but must be unique in the system.  
Range from 1-250

ID (secondary Adress): Not changeable, it is the serial number of the sensor

Baud rate: 2400, 4800, 9600

Medium: selectable mediums according MBus specification

2.8.1 Values settings

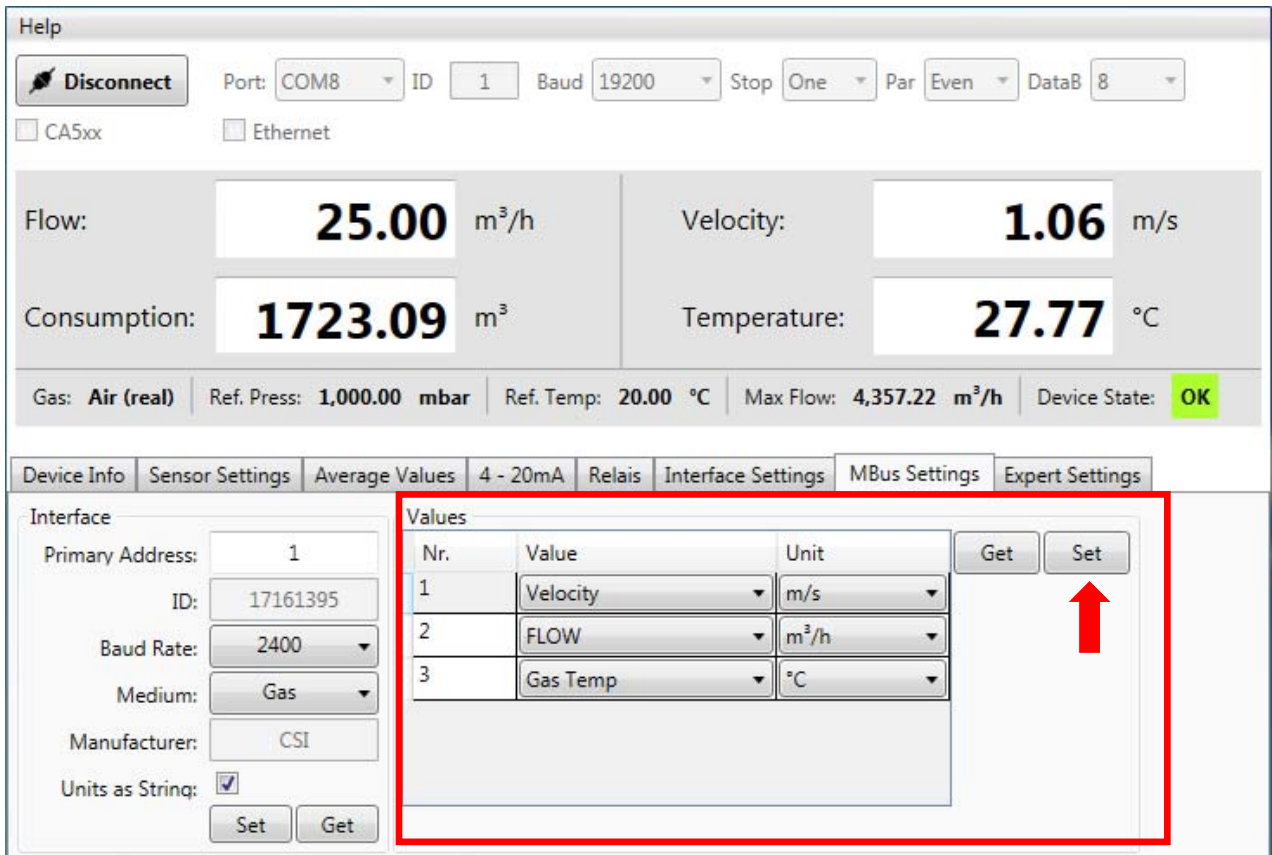

Basically, production setting is the “Fixed Data Structure” transmission mode, means 3 values with defined units will be transferred.

- (Flow in m<sup>3</sup>/h, consumption in m<sup>3</sup>, temperature in °C).

By activation of “Units as String”  the transmission mode is switched to the “Variable Data Structure”. This allows you to select the values and there units individually. All values stored in the sensor with their units could be selected. Up to 20 values are possible. Settings are stored by pressing corresponding “Set”-button.

**Remark:!**

Change to mode “Units as String” by pressing “Set” button of Interface settings.

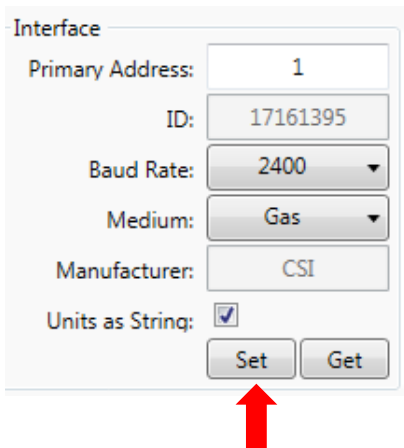



**Manufactured and sold by:**

Kobold Messring GmbH  
Nordring 22-24  
D-65719 Hofheim  
Tel.: +49(0)6192-2990  
Fax: +49(0)6192-23398  
E-Mail: [info.de@kobold.com](mailto:info.de@kobold.com)  
Internet: [www.kobold.com](http://www.kobold.com)