

## Positive Displacement Flowmeter

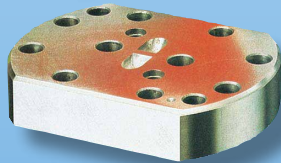

measuring  
•  
monitoring  
•  
analyzing

ZDM

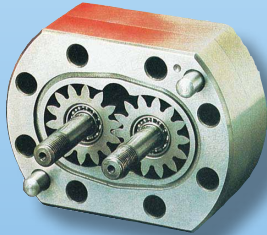

- Viscosities up to 100,000 cSt
- Accuracy:  $\pm 0.3\%$  of Flow
- Pressure: to 6500 PSIG
- Can Detect Flow Direction
- Handles a Variety of Lubricating Fluids



Order from: **C A Briggs Company**

622 Mary Street; Suite 101; Warminster, PA 18974

Phone: 267-673-8117 - Fax: 267-673-8118

[Sales@cabriggs.com](mailto:Sales@cabriggs.com) - [www.cabriggs.com](http://www.cabriggs.com)

KOBOLD Instruments, Inc.  
1801 Parkway View Drive  
Pittsburgh, PA 15205



**Positive Displacement Flowmeter Model ZDM**

**Description**

The ZDM is designed for difficult metering that requires precision. Available in either stainless steel or cast iron, it offers a state-of-the-art solution. Capable of operating at pressures to 6500 PSI and temperatures from -40°F to 410°F, it is rugged enough to operate under demanding requirements. It has the ability to precisely meter fluids with viscosities ranging from 1 cSt to 100,000 cSt. All liquids that can be pumped and have known lubrication properties can be measured, for example: gasoline, paraffin, kerosene, diesel, mineral oils, hydraulic oils, inks, dyes, paints, greases, polyurethane, glues, pastes, creams, resins, waxes, and many others.

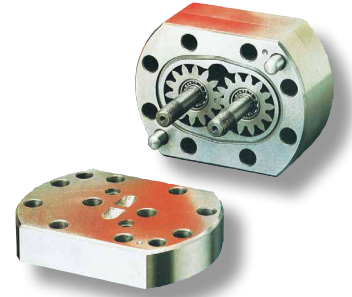

**Specifications**

<b>Viscosity Capability:</b>	1...100,000 cSt	<b>Max. Pressure</b>	
<b>Accuracy:</b>	±0.3% of Reading (Ranges: 02-40) ±0.5% of Reading (Range 50):	<b>Cast Iron:</b>	4500 PSIG 5000 PSIG (range code 50)
<b>Repeatability:</b>	±0.05% of Reading	<b>Stainless Steel:</b>	6500 PSIG
<b>Orientation Sensitivity:</b>	None	<b>Temperature Range</b>	
<b>Inlet/Outlet Location:</b>	Bottom Ports; Parallel or Side Ports; 180° Opposed	<b>Standard:</b>	-40...248 °F
<b>Construction</b>		<b>Ex-Design:</b>	-4...212 °F
<b>Housing:</b>	Cast Iron (DIN EN 1563) or Stainless Steel (DIN 1.4305)	<b>Option..C:</b>	-40...410 °F
<b>Gears:</b>	Stainless Steel (DIN 1.4122)	<b>Max Ambient:</b>	122 °F
<b>Shafts:</b>	Stainless Steel (DIN 1.4112)	<b>Required Filter Size</b>	
<b>Seals</b>		<b>ZDM-..02/..04/..07:</b>	10 µm
<b>Cast Iron Unit:</b>	FKM	<b>ZDM-..08/..09:</b>	20 µm
<b>St. Steel Unit:</b>	FKM	<b>ZDM-..10/..20/..40/..150:</b>	50 µm
<b>Optional:</b>	EPDM, PTFE, NBR	<b>Protection:</b>	IP 65 (Option "C": IP 64)
<b>Bearings</b>		<b>Electrical Input Power:</b>	Vs;10-28 V <sub>DC</sub> (±4 V <sub>DC</sub> ) 40 mA Max.
<b>Cast Iron Unit:</b>	Stainless Steel (DIN 1.4037)	<b>Output Signal:</b>	Push/Pull Voltage Pulse (0...Vs-1VDC)
<b>St. Steel Unit:</b>	Stainless Steel (DIN 1.4037)		

**Typical Pressure Loss vs Flow Rate Behavior**

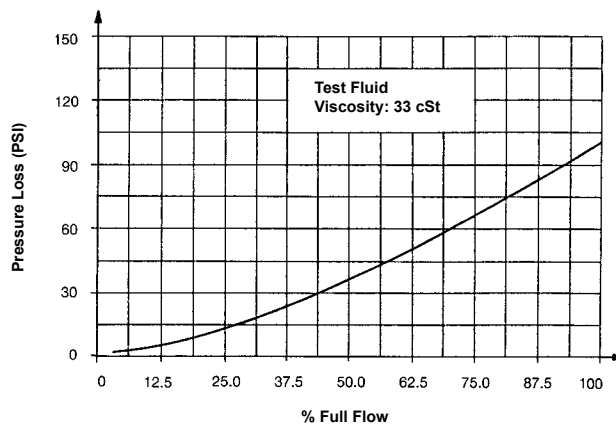



**Order Details\*** (Example: **ZDM-3209 B**)

Fitting Orientation, Type	Body Material	Range Oil (GPM) <sup>2)</sup>	K-factor (Pulses/Gal)	Fitting Size	Optional Fitting Size Add Suffix "..B"
<b>ZDM-1..</b> = Bottom Ports, BSP Threads <b>ZDM-2..</b> = Side Ports, BSP Threads <b>ZDM-3..</b> = Bottom Ports, NPT <b>ZDM-4..</b> = Side Ports, NPT <b>ZDM-5..</b> = Bottom Ports, SAE <b>ZDM-6..</b> = Side Ports, SAE	<b>..1..</b> = Cast Iron	<b>..02</b> = 0.0005...0.53	189272	3/8"	-
		<b>..04</b> = 0.0011...1.06	94636	1/2"	-
		<b>..07</b> = 0.0026...2.64	37854.4	1/2"	-
		<b>..08</b> = 0.0053...4.76	18927.2	1/2"	-
	<b>..2..</b> = Stainless Steel	<b>..09</b> = 0.0079...10.57	9463.6	1/2"	3/4"
		<b>..10</b> = 0.0132...21.13	3785.44	3/4"	1"
		<b>..20</b> = 0.0264...31.70	1892.72	3/4"	1"
		<b>..40</b> = 0.2642...66.00	946.36	1-1/4"	1-1/2"
		<b>..50<sup>1)</sup></b> = 0.39...138.00*	1135.63	1-1/2"	2"

All models include a 5 meter 4-pin Micro-DC M12 shielded electrical cable and DIN calibration certificate.

<sup>1)</sup>Range Code 50 is only available for cast iron versions.

<sup>2)</sup> Ranges based off of 21 cSt media. Media with a viscosity above or below this value may alter the effective range.

\* With your order, please also submit the media type, the operating pressure, and the viscosity at operating temperature.

**Options**

Description	Suffix
Optional Fitting Size (See Table Above)	<b>..B</b>
EPDM Seals in Place of Standard Seals	<b>..E</b>
PTFE Seals in Place of Standard Seals	<b>..T</b>
Intrinsically-Safe 5-10 V <sub>DC</sub> Pulse Sensor (incl. 1 Zener Barriers)	<b>..EX</b>
Externally-Mounted Sensor Pre-amplifier for Temperatures Above 248 °F (Internal Mounting is Standard)	<b>..C</b>



**ZDM for High Temperature (Option C)**  
(with Side Mount Ports)



**ZDM with Mounting Plate**  
(with Side Mount Ports)



Positive Displacement Flowmeter Model ZDM

ZDM-..02 to ZDM-..40

Dimensions

Cast Iron Version

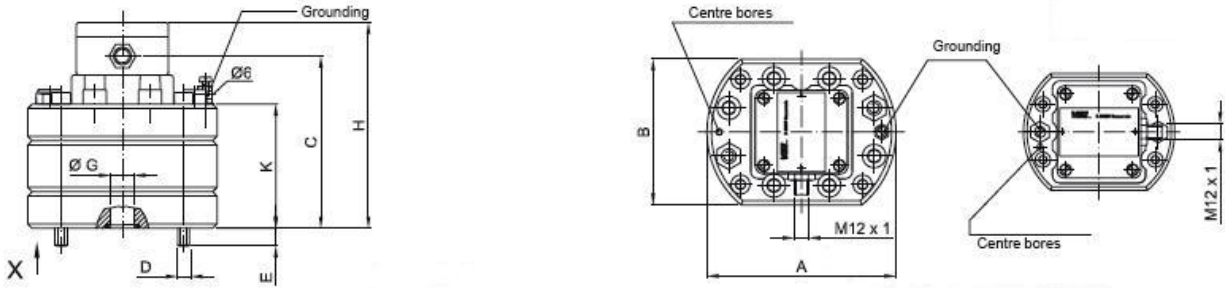

Model Number	Size (inches)												Weight (lbs)
	A	B	C	D	E	G	H	K	L	M	N	O-ring	
ZDM-..02	3.94	3.15	3.58	M 6	0.49	0.35	4.49	2.28	2.76	1.57	0.79	0.43 x 0.08	6.17
ZDM-..04	3.94	3.15	3.60	M 6	0.45	0.35	4.51	2.30	2.76	1.57	0.79	0.43 x 0.08	6.17
ZDM-..07	3.94	3.15	3.70	M 6	0.35	0.35	4.61	2.40	2.76	1.57	0.79	0.43 x 0.08	6.17
ZDM-..08	3.94	3.15	3.68	M 6	0.37	0.35	4.59	2.38	2.76	1.57	0.79	0.43 x 0.08	6.61
ZDM-..09	4.53	3.54	3.80	M 8	0.45	0.63	4.70	2.50	3.15	1.50	1.34	0.71 x 0.10	8.82
ZDM-..10	5.12	3.94	3.98	M 8	0.47	0.63	4.88	2.67	3.31	2.83	1.34	0.71 x 0.10	11.7
ZDM-..20	5.12	3.94	4.65	M 8	0.59	0.63	5.55	3.35	3.31	2.83	1.34	0.71 x 0.10	14.8
ZDM-..40	7.09	5.51	5.63	M 12	0.79	1.18	6.54	4.33	1.81	3.74	1.77	1.42 x 0.10	32.4

Connection Drawings

Cast Iron Version

Stainless Steel Version

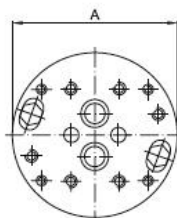
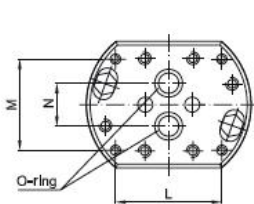

Side Ports

Bottom Ports

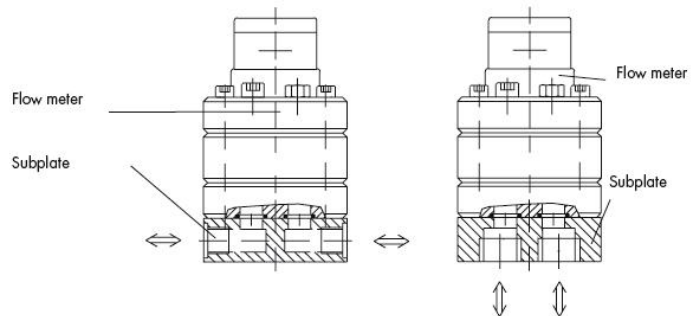

ZDM-..02 to ZDM-..40

Subplate Dimensions

Side Ports

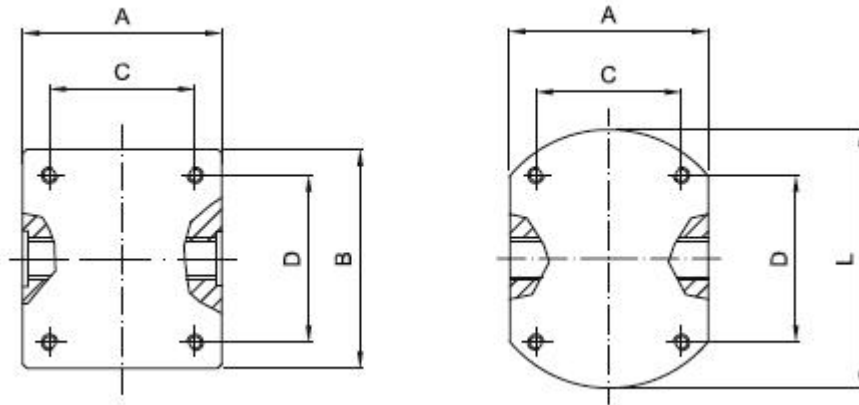

Bottom Ports

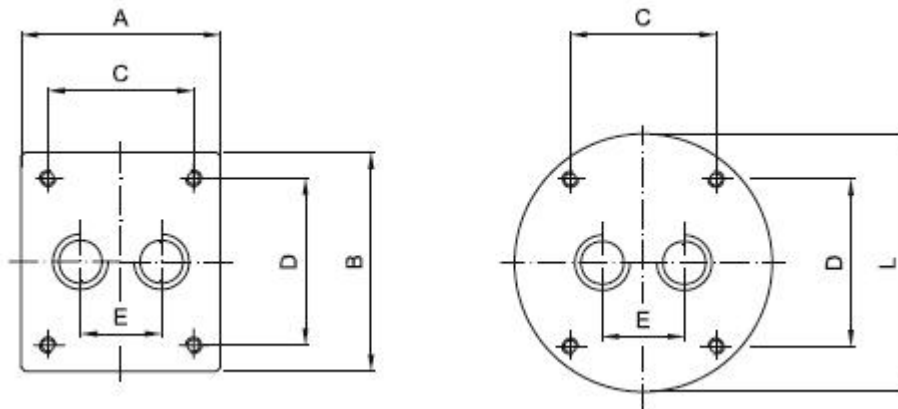

Model Number	Size (inch)					Weight (lbs)
	A	B	C	D	L	
ZDM-..02, ZDM-..04, ZDM-..07 & ZDM-..08	3.15	3.54	1.57	2.76	3.94	3.97
ZDM-..09	3.54	3.94	1.49	3.15	4.53	5.95
ZDM-..10 & ZDM-..20	3.94	4.33	2.83	3.31	5.12	7.94
ZDM-..40 Cast Iron 1 1/4"	4.72	5.12	3.94	4.33	-	16.31
ZDM-..40 Cast Iron 1 1/2"	5.51	4.72	4.72	3.94	-	16.31
ZDM-..40 Stainless Steel	5.51	-	3.94	4.33	7.09	26.46



Positive Displacement Flowmeter Model ZDM

ZDM-..150

Dimensions

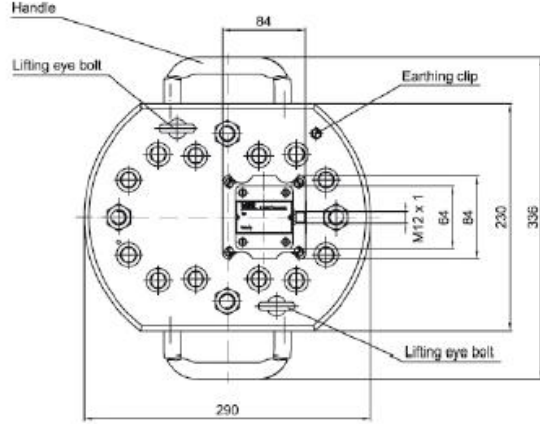
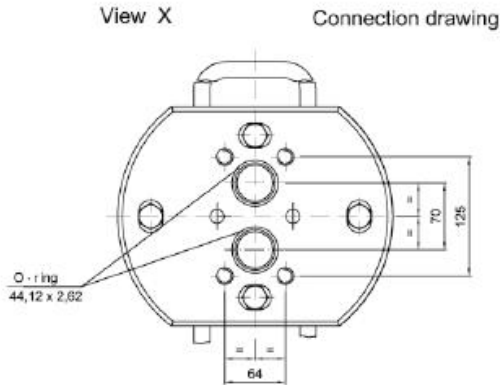
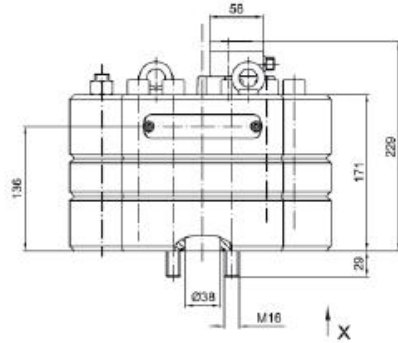

Subplate Dimensions

ZDM-..150 with 1-1/2" NPT Connection

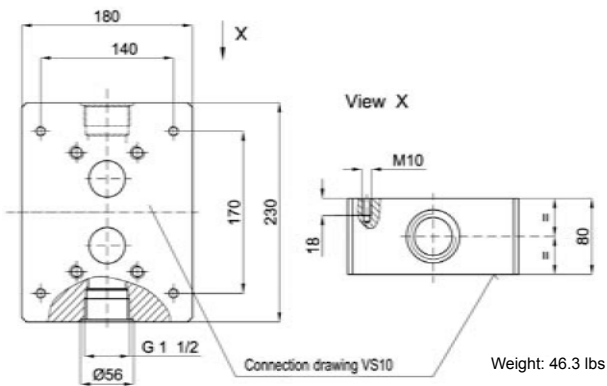

ZDM-..150 with SAE 1-1/2" Connection

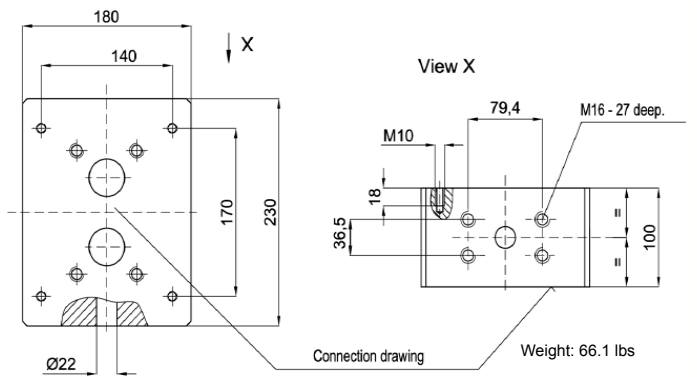

Dimensions in mm