



**Operating Instructions  
for  
Universal display**

**Model: DAG-T4T00WSR**



## 1. Contents

---

1. Contents.....	2
2. Note .....	4
3. Instrument Inspection.....	4
4. Regulation Use.....	4
5. Operating Principle.....	5
5.1 Signal input .....	5
5.2 Offset-Function .....	5
5.3 Alarms.....	6
5.4 Blocking initial of the alarm .....	7
5.5 Auto range function (AVTO.R) .....	7
5.6 Totalizing function .....	8
5.7 Totalizing/Integration time base (t.base).....	8
5.8 Totalizing/Integration scale factor (t.ScF).....	8
5.9 Batch totalizing function .....	8
5.10 F1 and F2 function keys.....	8
5.11 Totalizing function and alarms .....	9
5.12 Overflow alarm.....	9
5.13 Minimum and maximum.....	10
5.14 24 VDC auxiliary voltage source .....	10
6. Mechanical Connection.....	10
7. Electrical Connection .....	11
7.1 Recommendations for the installation .....	12
8. Operation .....	12
9. Commissioning.....	12
10. Description of the parameters .....	14
10.1 Operation cycle .....	14
10.2 Alarm cycle .....	14
10.3 Input Signal level parameters .....	16
10.4 Totalizing cycle .....	17
10.5 Calibration cycle .....	17
10.6 Password protection .....	18
11. Error messages, default and calibration .....	20
11.1 Error messages .....	20
11.2 Calibration and factor setting .....	20
12. Technical Data .....	21
13. Order Codes .....	22
14. Declaration of Conformance .....	23

**Manufactured and sold by:**

Kobold Messring GmbH  
Nordring 22-24  
D-65719 Hofheim  
Tel.: +49(0)6192-2990  
Fax: +49(0)6192-23398  
E-Mail: [info.de@kobold.com](mailto:info.de@kobold.com)  
Internet: [www.kobold.com](http://www.kobold.com)

## 2. Note

---

Please read these operating instructions before unpacking and putting the unit into operation. Follow the instructions precisely as described herein.

The devices are only to be used, maintained and serviced by persons familiar with these operating instructions and in accordance with local regulations applying to Health & Safety and prevention of accidents.

## 3. Instrument Inspection

---

Instruments are inspected before shipping and sent out in perfect condition.

Should damage to a device be visible, we recommend a thorough inspection of the delivery packaging. In case of damage, please inform your parcel service / forwarding agent immediately, since they are responsible for damages during transit.

### **Scope of delivery:**

The standard delivery includes:

- Universal display model: DAG-T4T00WSR
- Operating Instructions

## 4. Regulation Use

---

Any use of the universal display, model: DAG-T4T00WSR, which exceeds the manufacturer's specification, may invalidate its warranty. Therefore, any resulting damage is not the responsibility of the manufacturer. The user assumes all risk for such usage.

## 5. Operating Principle

The universal panel meter DAG-T4T00WSR is a quite versatile process indicator with totalizing function. With a wide list of input types - thermocouples, thermo-resistance, voltage and current the DAG-T4T00WSR is capable of measuring the majority of the variables and sensors encountered in industrial processes. Among others it contains two alarms (six functions), sensor offset, configuration of parameters protected by password, USB communication, indication in degrees Celsius (°C) or Fahrenheit (°F).

### 5.1 Signal input

Type	CODE	Measurement range
Thermocouple J	<i>tc J</i>	Range: -110 °C to +950 °C (-166 °F to +1742 °F)
Thermocouple K	<i>tc H</i>	Range: -150 °C to +1370 °C (-238 °F to +2498 °F)
Thermocouple T	<i>tc t</i>	Range: -160 °C to +400 °C (-256 °F to 752 °F)
Thermocouple N	<i>tc n</i>	Range: -270 °C to +1300 °C (-454 °F to 2372 °F)
Thermocouple R	<i>tc r</i>	Range: -50 °C to +1760 °C (-58 °F to 3200 °F)
Thermocouple S	<i>tc S</i>	Range: -50 °C to +1760 °C (-58 °F to 3200 °F)
Thermocouple B	<i>tc b</i>	Range: 400 °C to +1800 °C (752 °F to 3272 °F)
Thermocouple E	<i>tc E</i>	Range: -90 °C to +730 °C (-130 °F to 1346 °F)
RTD (Pt100)	<i>Pt</i>	Range: -200 °C to +850 °C (-328 °F to 1562 °F)
0 to 20 mA	<i>L_0_20</i>	<p style="text-align: center;">Linear analogue signal Indication programmable from -1999 to 30000.</p>
4 to 20 mA	<i>L_4_20</i>	
0 to 50 mV	<i>L_0_50</i>	
0 to 5 VDC	<i>L_0_5</i>	
0 to 10 VDC	<i>L_0_10</i>	

Table 01: Input types

### 5.2 Offset-Function

Allows fine adjustments to the PV (Process value) indication, correcting measurement errors that appear, for example, after the replacement of the temperature sensor.

# DAG-T4T00WSR

## 5.3 Alarms

The KOBOLD- digital universal panel meter DAG-T4T00WSR has two alarm outputs:

**ALARM1** - Relay SPST - Available on terminals 5 and 6.

**ALARM2** - Relay SPST- Available on terminals 3 and 4.

The alarms can assume the functions described on **Table 02**:

<b>oFF</b>	Alarm off.	
<b>Lo</b>	Alarm of the Absolute Minimum Value. It triggers when the value of the <b>PV</b> is <b>below</b> the value defined by the alarm <i>Setpoint</i> ( <i>SPA1</i> or <i>SPA2</i> ).	
<b>Hi</b>	Alarm of the Absolute Maximum Value. It triggers when the value of the <b>PV</b> is <b>above</b> the value defined by the alarm <i>Setpoint</i> .	
<b>di F</b>	Alarm of the Differential Value. In this function the parameters “ <b>SPA1</b> ” and “ <b>SPA2</b> ” represent errors (difference) between the PV and one reference value ( <i>ALrF</i> ).	
	SPA1 positive	SPA1 negative
<b>di FL</b>	Alarm of the Minimum Differential Value. It triggers when the value of the PV is <b>below</b> the point defined by: <b>ALrF-SPA1</b> (using alarm 1 as an example).	
	SPA1 positive	SPA1 negative
<b>di FH</b>	Alarm of the Maximum Differential Value. It triggers when the value of the PV is <b>above</b> the point defined by: <b>ALrF+SPA1</b> (using alarm 1 as an example).	

	SPA1 positive	SPA1 negative
t <sub>-Lo</sub>	Alarm of the Absolute Minimum Value. It triggers when the value of the totalizer (TOT) is <b>below</b> the value defined by the alarm <i>Setpoint</i> .	
t <sub>-Hi</sub>	Alarm of the Absolute Maximum Value. It triggers when the value of the totalizer (TOT) is <b>above</b> the value defined by the alarm <i>Setpoint</i> .	
t <sub>-ofL</sub>	Alarm at overflow of totalizer.	
iErr	Alarms of Sensor Break (Sensor <i>Break Alarm</i> ). It is activated when the Input presents problems such as interrupted sensor, bad connection, etc.	

Table 02: Alarm functions

**Note:** The figures are also valid for Alarm 2 (SPA2).

## 5.4 Blocking initial of the alarm

The initial blocking option inhibits the alarm from being recognized if an alarm condition is present in the process when the indicator is first energized. The alarm will be enabled only after the occurrence of no alarm condition.

The initial blocking is useful, for example, when one of the alarms is set up as a minimum value alarm, which may cause the activation of the alarm soon upon the process start-up; an occurrence that maybe undesirable in many cases.

The initial blocking feature is not valid for the functions t.lo, t.Hi, t.ofl and ierr.

## 5.5 Auto range function (AVTO.R)

The indication limits can be set by using operator's knowledge about the process. By knowing the relation between the current process variable value and the desired indication in two points the indication limits can be easily set.

The known PV values are set through P1.Set and P2.Set parameters which are presented when the Auto Range function is enabled: avto.r= yes.

If the function Auto Range is used the parameters inLL and inHL are automatically defined.

This function is only available for analog linear input signals.

## 5.6 Totalizing function

This function allows continuous integration of instant PV values.

This continuous integration is stored in a non volatile internal memory and can also be presented at the indicator display by choosing TOTAL screen which is identified by the symbol TOT. This symbol is always presented when the TOTAL is being presented.

The TOTAL value is presented with up to 9 digits (999999999) but when this value is bigger than 99999 it is splitted in two separate screens indicating the most and least significant parts and identified with the symbols TOT HIGH and TOT LOW on the display.

The TOTAL value can be erased through the keyboard or can be reset every time the indicator is powered up.

## 5.7 Totalizing/Integration time base (t.base)

The instant PV value integration is executed at a fixed time interval which is defined by a configuration parameter.

The Time Base options are "second", "minute", "hour" and "day".

## 5.8 Totalizing/Integration scale factor (t.ScF)

Before being added to the total, the instant PV value is multiplied by the Scale Factor.

## 5.9 Batch totalizing function

This function allows the operator to execute the totalization only when a pre-configured function key is pressed.

This function allows the user to add or subtract the instant PV value to/from the total accumulated value.

## 5.10 F1 and F2 function keys

The F1- and F2-Keys can execute several different functions which should be set by the user when configuring the indicator.

<i>no</i>	Key not used to any special function.
<i>b_Add</i>	Executes Batch Function - Addition
<i>b_Sub</i>	Executes Batch Function - Subtraction
<i>rSt_to</i>	Reset Total value
<i>d-h i</i>	Present maximum read value
<i>d-Lo</i>	Present minimum read value
<i>r_Loh i</i>	Reset minimum and maximum values



Two different functions can be assigned to F1 and F2 keys. The function to be executed, Primary or Secondary, is determined by the amount of time the function key is being pressed. If the function key is pressed for less than 1 second the Primary function is executed.

If the key is pressed for more than 3 seconds then the Secondary function is executed.

The combination of the keys F1 and F2 pressed simultaneously can also execute a Special Function. All Special Functions are available to the operator as follows:

**F1\_1:** F1 Key, Primary Function.

**F1\_2:** F1 Key, Secondary Function.

**F2\_1:** F2 Key, Primary Function.

**F2\_2:** F2 Key, Secondary Function.

**F12\_1:** F1+F2 Keys, Primary Function.

**F12\_2:** F1+F2 Keys, Secondary Function.

## 5.11 Totalizing function and alarms

The totalization alarm functions **t\_lo** and **t\_hi** allow the user to notify when a total value is reached.

The alarm defined as Totalization Minimum Value Alarm (**t\_lo**) is set when the totalization value goes below the configured setpoint.

The alarm defined as Totalization Maximum Value Alarm (**t\_hi**) is set when the totalization value goes above the configured setpoint.

As the totalization value can indicate up to 99999 99999 (or -9999 99999) the set point values behave the same way. If the adjusted SP goes above 99999 (or below -9999) the second SP part is displayed allowing the operator to see values up to 99999 99999 (or -9999 99999).

The flags HIGH and LOW identify if the part being displayed is the SP most significant part (HIGH) or the least significant part (LOW).

The totalization alarm (SP) is defined through the values SPA1 and SPA2. This two parameters behave different from other parameters. The Back key allows the operator to change the SP decimal digit to be set.

## 5.12 Overflow alarm

This alarm function is set when the totalized value surpasses 9999999999, which is the maximum indication value.

## 5.13 Minimum and maximum

The indicator is continuously storing the extreme input indication measurements, or the minimum and maximum values. These values can be displayed at any time by the operator by pressing the keys F1 and F2. Notice that the function Keys should be set to `d_h i` and `d_Lo`.

To reset the maximum and minimum values and start another monitoring cycle, just execute the function `r_Lo h i`, which can be assigned to the keys F1 and F2. When the indicator is powered off this information is not stored.

## 5.14 24 VDC auxiliary voltage source

The standard version of the DAG-T4T00WSR provides an auxiliary power supply (24 VDC) for exciting field transmitters (terminal 13 on the rear panel).

## 6. Mechanical Connection

---

The indicator is meant for panel mounting. The sequence of steps is:

- Prepare a cut out of 93.0 by 45.5 mm on the panel
- Remove the mounting clamp from the indicator
- Insert the indicator into the cut out from the front side of the panel
- Place the clamp on the indicator again, pressing until firm grip to the panel

## 7. Electrical Connection

The terminals configurations are shown in Figure 01.

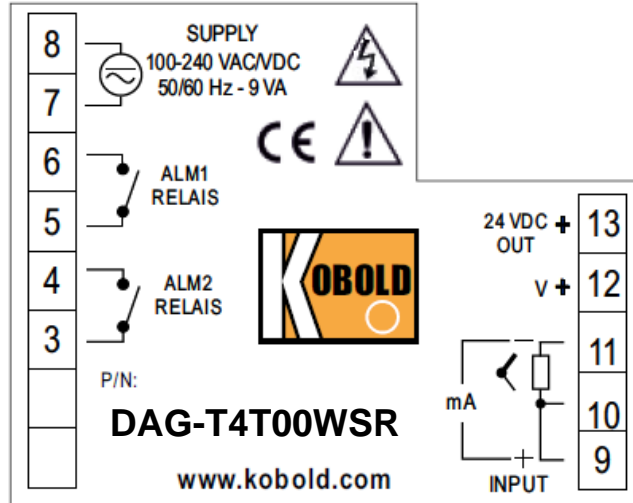

Figure 01: Input connections and power supply

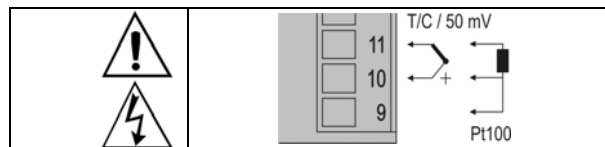

Figure 02: Thermocouple, Pt100 and 50 mV signal connection

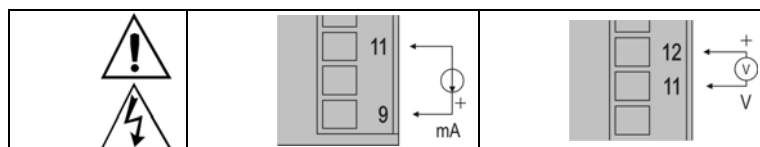

Figure 03: Current (mA) and Voltage (V) signal connection

This indicator offers an auxiliary 24 VDC +/-15% at 50 mA power supply which is typically applied to power up two wire 4 to 20 mA field transmitters. The **Figure 04** presents the wiring for this application.

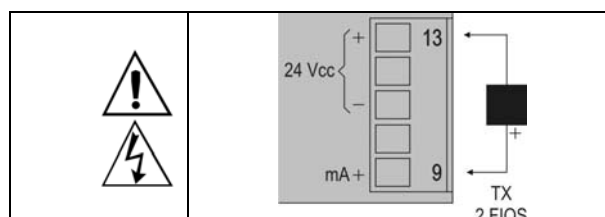

Figure 04: Auxiliary 24 VDC usage example

## 7.1 Recommendations for the installation

- To minimize the pick-up of electrical noise, the low voltage DC connections and the sensor input wiring should be routed away from high-current power conductors. If this is impractical, use shielded cables. In general, keep cable lengths to a minimum.
- The input signal conductors shall be positioned throughout the factory separate from the output and the power supply conductors, in grounded conduits if possible.
- The power supply of the electronic instruments shall come from a proper source for the instrumentation network.
- It is recommended to use RC FILTERS (0,1uF in series with 100 ohms) to suppress the noise generated by contactors coils, solenoids, etc.

## 8. Operation

---

The indicator front panel, together with its elements, can be seen on:



Figure 02: Identification of the front panel parts.

**Display:** Shows the process variable (**PV**), the configuration parameter prompts and their respective values/conditions.

**Indicators A1 and A2:** signalize the occurrence of an alarm condition.

**Key P:** Used to walk through the parameters in the menu cycles.

**▲ Increment key and ▼ Decrement key:** Used to change parameter values.

**Key ◀:** Go back to the previous displayed parameter. This key changes its behavior starting to set the decimal digit to set.

## 9. Commissioning

---

When the controller is powered up, its firmware version is displayed for 3 seconds, after which the **DAG-T4T00WSR** starts normal operation, when the value of **PV** is displayed and the outputs are enabled.

Before the indicator is ready to be used in a given process, it requires some basic configuration, consisting of assigning values to the parameters according to the desired behavior. The user shall understand the importance of each parameter and determine a valid condition or a valid value for each one of them.

The configuration parameters are grouped in levels according to their affinity. The 5 parameter levels are:

- 1 – Operation
- 2 – Alarms
- 3 – Input
- 4 – Totalizer
- 5 – Calibration

The “**P**” key provides the access to the levels and to the parameters of these levels.

Keeping the **P** key pressed, at every 2 seconds, the indicator jumps from one level to another, presenting the first parameter of each level:

**Measurement PV>>FUA l>>TYPE>>tot>>PASS>>PV ...**

To enter a particular level, simply release the **P** key when the first parameter in that level is displayed.

To walk through the parameters in a level, press the **P** key with short strokes. To go back to the previous parameters, use the  Key.

The display alternates the presentation of the parameter prompt and its value. The parameter value is displayed with a light blinking to differentiate it from the parameter prompt.

Depending on the level of parameter protection adopted, the parameter **PASS** precedes the first parameter in the level where the protection is active. See section Protection configuration.

## 10. Description of the parameters

### 10.1 Operation cycle

<i>PV</i>	<p><b>Indication Display of PV:</b> The value of the measured variable (PV) is shown on the main display (red).</p>
<i>TOE</i>	<p><b>Totalizing value:</b> When this value is bigger than 99.999 it is splitted in two separate screens indicating the most and least significant parts and identified with the symbols TOT HIGH and TOT LOW on the display</p>
<p><i>SP_A1</i>  <i>SP_A2</i>  <i>SetPoint</i>  <i>Alarm</i></p>	<p><b>Alarm SP:</b> Value that defines the alarm activation point. For the alarms set up with the functions of the type <b>Differential</b> or <b>Band</b>, these parameters define the maximum differences accepted between <b>PV</b> and a reference value defined in the parameter <i>ALRF</i>. For the alarm function <i>Err</i>, this parameter is not used. Parameters show in this level only when enabled in the parameters <i>SP1_E</i> and <i>SP2_E</i>.</p>

### 10.2 Alarm cycle

<p><i>F_A1</i> <i>F_A2</i></p>	<p>Alarm Functions. It defines the functions of the alarms among the options in <b>Table 02</b> (page 5).</p>
<p><i>ALRF</i> <i>Alarm</i> <i>Reference</i></p>	<p>Reference value used by the alarms with differential function, minimum differential or maximum differential.</p>
<p><i>dP_A1</i>  <i>dP_A2</i> <i>Alarm</i> <i>Referenz</i></p>	<p>Totalization alarm SP decimal point.</p>
<p><i>SP_A1</i> <i>SP_A2</i> <i>SetPoint</i> <i>Alarm</i></p>	<p>Alarm SP: Value that defines the point of activation of the alarm outputs. For the alarms programmed with the functions of the type <b>Band</b> and <b>Differential</b>, these parameters represent the deviations. For the <i>Err</i> and <i>toFL</i> alarm functions, this parameter has no meaning.</p>

<p><b>SP1_E</b> <b>SP2_E</b> <i>SP enable</i></p>	<p>It allows the parameters <b>SP_A1</b> and <b>SP_A2</b> to be displayed also in the indicator operation cycle.</p> <p><b>YES</b>: Shows the parameters <b>SP_A1</b> / <b>SP_A2</b> in the operation cycle.</p> <p><b>n0</b>: DOES NOT show the parameters <b>SP_A1</b> / <b>SP_A2</b> in the operation cycle.</p>
<p><b>bLA1</b> <b>bLA2</b> <i>Blocking Alarm</i></p>	<p>Alarms Initial Blocking (see section 4.5).</p> <p><b>YES</b>: Enables the initial blocking</p> <p><b>n0</b>: Inhibits the initial blocking</p>
<p><b>HHYA1</b> <b>HHYA2</b> <i>Hysteresis of Alarms</i></p>	<p>Alarm Hysteresis. It defines the difference between the value of PV at which the alarm is triggered and the value at which it is turned off.</p>
<p><b>FLSh</b> <i>Flash</i></p>	<p>It allows signalization of an alarm condition occurrence by flashing the indication of PV on the indication display.</p> <p><b>YES</b>: Enables alarm signalization by flashing <b>PV</b>.</p> <p><b>n0</b>: Disables the flashing <b>PV</b>.</p>

## 10.3 Input Signal level parameters

<b>TYPE</b> <i>Type</i>	Input Type. Selection of the input type, used by the indicator. Refer to <b>Table 01</b> on page 4.
<b>FLtr</b> <i>Filter</i>	Digital Input Filter – Used to improve the stability of the measured signal (PV). Adjustable between 0 and 20. At 0 (zero) it means filter turned off and 20 means maximum filter. The higher the filter value, the slower is the response of the measured value.
<b>dP_PD</b> <i>Decimal Point</i>	It determines the position of the decimal point on the display.
<b>unit</b> <i>Unit</i>	It defines the temperature unit to be used: [ C indication in Celsius. F indication in Fahrenheit.
<b>OFF5</b> <i>Offset</i>	Parameter that allows the user to make fine adjustments to the indicated PV value.
<b>Auto_r</b> <i>Auto Range</i>	Enables the scaling of the <b>PV</b> by applying the input signal.
<b>P1_SEt</b>	PV value to the first process known point when <i>Auto Range</i> function is enabled ( <b>Auto_r = YES</b> ).
<b>P2_SEt</b>	PV value to the second process known point when <i>Auto Range</i> function is enabled ( <b>Auto_r = YES</b> ).
<b>inLL</b> <i>Input Low Limit</i>	It defines the <u>lower</u> value of the indication range when the input types of 0-20 mA, 4-20 mA, 0-50 mV, 0-5 V and 0-10 V are used ( <b>Auto_r = no</b> ).
<b>inHL</b> <i>input High Limit</i>	It defines the <u>upper</u> value of the indication range when the input types of 0-20 mA, 4-20 mA, 0-50 mV, 0-5 V and 0-10 V are used ( <b>Auto_r = no</b> ).
<b>F1_1</b>	Defines the function to be executed by F1 and F2 keys:  no No associated function b_Add Executes Batch Function - Addition b_Sub Executes Batch Function - Subtraction rSt_to Reset Total value d-h i Present maximum read value d-Lo Present minimum read value r_LoH i Reset minimum and maximum values
<b>F1_2</b>	
<b>F2_1</b>	
<b>F2_2</b>	
<b>F12_1</b>	
<b>F12_2</b>	



## 10.4 Totalizing cycle

<b>tot</b>	Defines the indicator operation mode.  <b>on</b> Totalizing function enabled <b>oFF</b> Totalizing function disabled <b>bAtch</b> Batch operation
<b>t_dPPD</b>	Totalizer Decimal Point Position Defines the decimal point position when presenting the total value.
<b>t_bASE</b> Totalizer time base	Defines the time totalizing function time base.  <b>SEc</b> seconds <b>ī ī n</b> minutes <b>Hour</b> hours <b>dAY</b> days
<b>t_ScF</b> TotalizerScale Factor	Totalizer Scale Factor. Can be set from 0,001 to 65,0.
<b>Lo_cUT</b> LowCut	Totalizer low cut value. Defines the lowest PV instant value limit considered for totalization and does not integrate any value below.
<b>PU_rSt</b> Power Up Reset	Power up Reset Defines if the total value is restored or reset on indicator power up <b>YES</b> Reset Totalizer <b>no</b> No reset of the Totalizer

## 10.5 Calibration cycle

All types of input are calibrated in the factory. In case a recalibration is required; it shall be carried out by a specialized professional. In case this cycle is accidentally accessed, do not perform alteration in its parameters. The factory calibration can be restored in the parameter rstr.

<b>PASS</b>	<u>Password</u> . Entering the Access password. This parameter is presented before the protected cycles. See item Protection of Configuration.
<b>CCAL ib</b>	<u>Calibration</u> . Enables the possibility for calibration of the indicator. When the calibration is not enabled, the related parameters are hidden.
<b>ī nLCC</b>	<u>Input Low Calibration</u> . Indication of the low scale calibration signal applied to the input.
<b>ī nHCC</b>	<u>Input High Calibration</u> . Indication of the full scale calibration signal applied to the input.

<i>rStr</i>	<u>Restore</u> . It restores the factory input calibration and the indicator factory parameters, disregarding any modifications carried out by the user.
<i>CCJ</i>	<u>Cold Junction</u> . Temperature of the indicator cold junction.
<i>PAS-- C</i>	<u>Password Change</u> . It allows the definition of a new access password, always different from zero.
<i>Prot</i>	<u>Protection</u> . Sets up the Level of Protection. See <b>Table 03</b> .
<i>FREQ</i>	<u>Frequency</u> . Frequency of the local electrical network.
<i>SnH</i>	Serial number 4 most significant digits.
<i>SnL</i>	Serial number 4 least significant digits.

## 10.6 Password protection

The **DAG-T4T00WSR** indicator provides means for protecting the parameters configurations, not allowing modifications to the parameters values, avoiding tampering or improper manipulation. The parameter **Protection** (*Prot*) in the Calibration level determines the protection strategy, limiting the access to particular levels, as shown in the table below.

ProtectionLevel	ProtectedLevels
1	Only the Calibration level is protected.
2	Totalization and Calibration levels are protected.
3	Input, Totalization and Calibration levels are protected.
4	Alarms, Input, Totalization and Calibration levels are protected.

**Table 03:** Levels of Protection of the configuration

## ACCESS PASSWORD

The protected levels, when accessed, request the user to provide the **Access Password** for granting permission to change the configuration of the parameters on these levels.

The prompt *PASS* precedes the parameters on the protected levels. If no password is entered, the parameters of the protected levels can only be visualized.

The Access Password is defined by the user in the parameter *Password Change* (*PAS\_ \_*), present in the Calibration Level. **The factory default for the password code is 1111.**

## PROTECTION OF THE ACCESS PASSWORD

The protection system built into the controller blocks for 10 minutes the access to protected parameters after 5 consecutive false attempts of entering the correct password.

## MASTER PASSWORD

The Master Password is intended for allowing the user to define a new password in the event of it being forgotten. The Master Password doesn't grant access to all parameters, only to the *Password Change* parameter (*PAS\_ \_*). After defining the new password, the protected parameters may be accessed (and modified) using this new password.

The master password is made up by the last three digits of the serial number of the controller **added** to the number 9000.

As an example, for the equipment with serial number 07154321, the master password is 9 3 2 1.

The indicator serial number can be obtained by pressing  for 5 seconds.

## 11. Error messages, default and calibration

---

### 11.1 Error messages

Connection errors and inadequate programming are the most common errors found during the controller operation. A final revision may avoid loss of time and damages.

The controller displays some messages to help the user identify problems.

MESSAGE	DESCRIPTION OF THE PROBLEM
-----	Open input. No sensor or signal.
Err 1 Err 6	Connection and/or configuration errors. Check the wiring and the configuration.

Other error messages may indicate hardware problems requiring maintenance service.

### 11.2 Calibration and factor setting

All inputs are factory calibrated and recalibration should only be done by qualified personnel. If you are not familiar with these procedures do not attempt to calibrate this instrument.

The calibration steps are:

- a) Configure the input type to be calibrated.
- b) Configure the lower and upper indication limits for the maximum span of the selected input type.
- c) Connect to the input terminals a signal corresponding to a known indication value a little above the lower display limit.
- d) Access the parameter  $inLC$ . With the keys  $\Delta$  and  $\nabla$  adjust the display reading to match the applied signal. Then press the  $P$  key to store.
- e) Inject a signal that corresponds to a value a little lower than the upper limit of indication.
- f) Access the parameter  $inHC$ . With the keys  $\Delta$  and  $\nabla$  adjust the display reading to match the applied signal. Then press the  $P$  key to store.

**Note:** When checking the controller calibration with a Pt100 simulator, pay attention to the simulator minimum excitation current requirement, which may not be compatible with the 0.170 mA excitation current provided by the controller.

## 12. Technical Data

Display:	LED-display, 5-digits, red with 16 mm high digits
Display range input signal:	-1999...30000
Display range totalizer:	0...9999999999 (alternating display)
Indicators:	Ten red indicators for alarm status, communication, totalizer function, min.and max. value
°C, °F	ON, depending on temperature range
A1, A2	ON, when alarm is active
TOT	ON, when displaying totalizer value
HIGH	ON, when digit 6 to 10 is displayed
LOW	ON; when digit 1 to 5 is displayed
Buttons:	4 front keys for programming and setting up the setpoints
Thermocouples:	Type J, K, T, N, R, S, B, E; internal cold junction
RTD:	Pt100 in 3-wire connection (alpha = 0.00385)
Linear inputs:	0 V...5/19 V, 0/4 mA...20 mA, 0 mV...50 mV

Sensor type	Measurement range
TC type J	-110 °C ... 950 °C (-166 °F ... 1742 °F)
TC type K	-150 °C ... 1370 °C (-238 °F ... 2498 °F)
TC type T	-160 °C ... 400 °C (-256 °F ... 752 °F)
TC type N	-270 °C ... 1300 °C (-454 °F ... 2372 °F)
TC type R	-50 °C ... 1760 °C (-58 °F ... 3200 °F)
TC type S	-50 °C ... 1760 °C (-58 °F ... 3200 °F)
TC type B	400 °C ... 1800 °C (752 °F ... 3272 °F)
TC type E	-90 °C ... 730 °C (-130 °F ... 1346 °F)
RTD	-200 °C ... 850 °C (-328 °F ... 1562 °F)

Accuracy:	
Thermocouples type J, K, T, E:	0.25 % of span +/-3 °C
Thermocouples type N, R, S, B:	0.25 % of span +/-3 °C
Pt100:	0.2 % of span
Linear analogue input:	0.2 % of span
Resolution:	Internal resolution with 65535 steps (16 bits), display resolution 32000 steps
Measurement rate:	55 Hz with programmable digital filter
Input impedance:	Thermocouples, Pt100, 0...50 mV: >10 MΩ; 0...5/10 V: >500 kΩ; 0/4...20 mA: 100 Ω
Excitation:	24 V <sub>DC</sub> +/-15% @ 50 mA
Relay outputs:	2 relay SPST, 1.5 A at 240 V <sub>AC</sub> /30 V <sub>DC</sub>
Supply:	100...240 V <sub>AC</sub> +/- 10%, 50/60 Hz, 6 VA

# DAG-T4T00WSR

Connections:

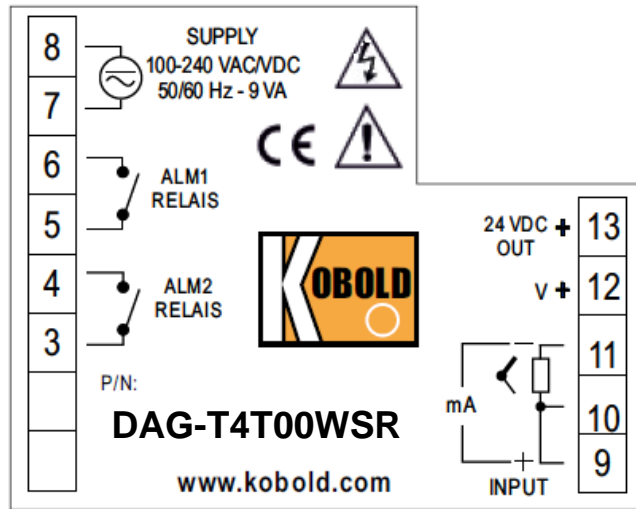

Protection: IP65 from the front (with rubber sealing), back side IP20  
 Housing: Plastic case Polycarbonat (PC)  
 L94-V2, back panel ABS+PC UI94 V-0  
 Dimensions: W 96 mm x H 48 mm x D 35 mm;  
 Panel cut out: 93.0 x 45.5 mm;  
 mounting with plastic clamps  
 Connection: Plug-in terminal blocks, 5 mm pitch  
 Ambient conditions: Operating temperature: 0 °C...+50 °C;  
 relative humidity 80% rF @ 30 °C, for temperature above  
 30 °C, reduction by 3% rF for 0 °C

## 13. Order Codes

Example: DAG-T4T00WSR

Model	Version	Input	Supply	Output	Sensor supply/ digital input	Relay	Display
DAG-	T4 = Digital- anzeige, 5-stellig, 96x48 mm	T = Pt100/ Thermo- elemente einstellbar	0 = 100...230 V <sub>AC</sub>	0 = ohne	W = mit Sensor- versorgung 24 V <sub>DC</sub>	S = 2 Schließer	R = rot

## 14. Declaration of Conformance

---

We, KOBOLD Messring GmbH, Hofheim-Ts, Germany, declare under our sole responsibility that the product:

**Universal Panel Meter      Model: DAG-T4T00WSR**

to which this declaration relates is in conformity with the standards noted below:

**CISPR11/EN55011**  
EMC-emission

**EN 61000-4-2**  
**EN 61000-4-3**  
**EN 61000-4-4**  
**EN 61000-4-5**  
**EN 61000-4-6**  
**EN 61000-4-8**  
**EN 61000-4-11**  
EMC-immunity

**EN61010-1:1993**  
**EN61010-1/A2:1995**  
Safety Extra Low Voltage

Also the following EWG guidelines are fulfilled:

**2006/95/EC                      Low Voltage Directive**  
**2004/108/EC                  EMC Directive**

Hofheim, 17. Feb. 2014

  
H. Peters  
General Manager

  
M. Wenzel  
Proxy Holder