

WIF-1250 Water in Fuel Sensor

- ▶ Designed for OHV and Generator Set applications
- ▶ Compact size, easy to install
- ▶ Operates in plastic or metal tanks
- ▶ Reliable and affordable OEM solution
- ▶ Solid-State – no moving parts

The WIF-1250 sensor is an innovative, no-moving-parts solution specifically designed to detect the presence of water in fuel. The sensor is an ideal solution for OEM's of off-highway vehicles, locomotive and generator sets. It is also ideal for use with fuel filters. Based on reliable conductivity technology, WIF-1250 sensors are built from robust nickel plated steel for compatibility with temperatures up to 257°F (125°C), and are suited for the most challenging environments or applications. A 5-second delay circuit prevents "slosh" actuation. The sensor is easily mounted in any position.

Specifications

Housing Materials	Nickel plated steel, electrolytic nickel plated & fused glass conductivity pin insulator
Sensing Element Length	0.2" (5.1 mm)
Operating Pressure	750 PSI (51.7 bar) @ 70°F (21°C)
Operating Temperature	-40°F to 257°F (-40°C to 125°C)
Sensitivity	10,000 Ohms (fluid resistance)
Slosh Dampening	5 seconds
Supply Voltage	8 to 32 V DC
Current Consumption	<20 mA
Output	Open collector, sinking output
Output Load Capability	250 mA max.
Electrical Connection	20 AWG 3-Conductor Cable, 15" (381 mm)
Approvals	CE

Dimensions

1/4" NPT Mounting

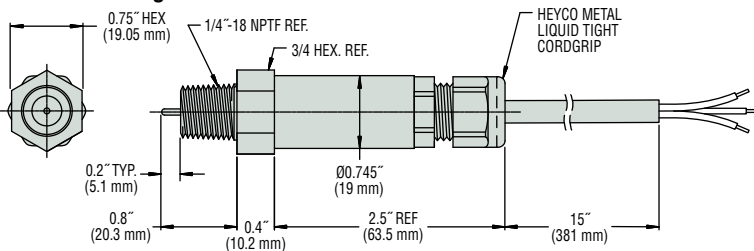

M12x1.5 Mounting

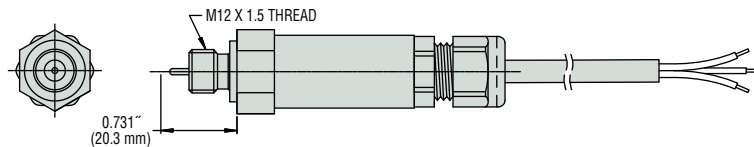

CE

Typical Applications

To detect water in:

- Fuel filters
- Diesel fuel storage tanks

Wiring Diagrams

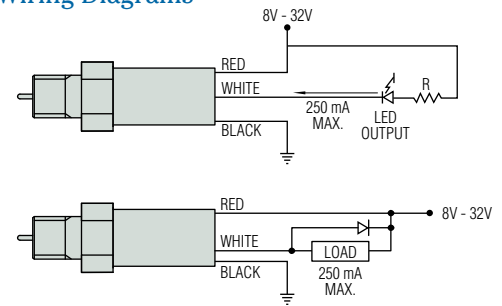

Resistance vs. Operating Temperature

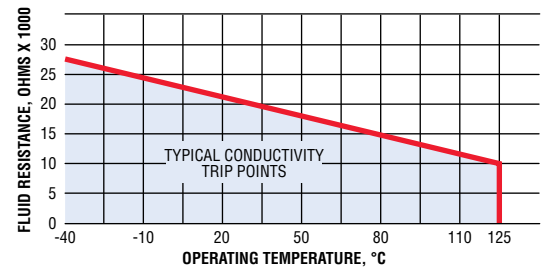

Operating Principle

WIF-1250 liquid level sensors are solid-state devices designed to detect the presence or absence of water in fuel. Each sensor contains integral, high-temperature-rated electronics that generate an alternating voltage to a probe tip. The presence of water completes the circuit which, in turn, changes the condition of the transistor output. Output options vary and can be used to actuate relays, indicator lights or LEDs, as well as to interface with CMOS/TTL logic, PLCs or microprocessors.

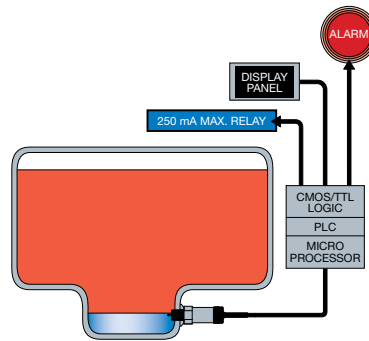

Conventional Conductivity Probe

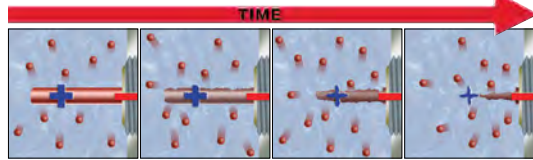

When a single potential (DC Voltage) is applied to a probe submerged in conductive liquid, metal from that probe will be lost over time via electrolysis.

Gems WIF-1250 Probe

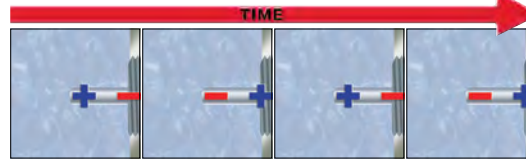

Gems applies extra circuitry to produce an alternating potential (alternating +/- DC square wave). Metal lost in one state is retrieved in the alternating state, resulting in virtually zero probe material loss.

How to Order

Select Part Number based on Mounting Thread and Switch Logic.

Probe Condition at Current Sink	Part Numbers	
	1/4" NPT	M12x1.5
Wet	238737	238856
Dry	238773	238855

LEVEL SWITCHES - SINGLE POINT