



VRF® II Series Installation & Operation Manual

Order from: **C A Briggs Company**

622 Mary Street; Suite 101; Warminster, PA 18974

Phone: 267-673-8117 - Fax: 267-673-8118

Sales@cabriggs.com - www.cabriggs.com



VRF® II Series Installation & Operation Manual

CONTENTS

I.	HANDLING & STORAGE.....	1
	Inspection and Handling	
	Disposal and Recycling	
	Storage	
II.	GENERAL SAFETY.....	2
	Authorized Personnel	
	Use	
	Misuse	
III.	PRODUCT DESCRIPTION	3
	Function	
	Applications	
	Features	
	Technical Specifications	
	Approvals	
IV.	MECHANICAL INSTALLATION	5
	Guidelines	
	Mounting Considerations	
	Figure 1. Mounting in Relation to Flow of Material	
V.	ELECTRICAL INSTALLATION.....	7
	General Safety	
	Disconnect Requirements for Permanently Installed Equipment	
	Protective Earth Ground	
	Electrical Connections	
	Conduit Cable Connection	
	VRF II Series Integral Model Only	
	VRF II Series Remote Model Only	
	Figure 2. VRF II Series - Integral Enclosure with Cover Removed - STANDARD	
	Figure 3. VRF II Series - Integral Enclosure with Cover Removed - ADVANCED	
	Figure 4. Power and Ground Connections	
	Figure 5. Main Relay Connections	
	Figure 6. Auxiliary Relay Connections - ADVANCED ONLY	
	Figure 7. VRF II Series - Remote Enclosure with Cover Removed - STANDARD	
	Figure 8. VRF II Series - Remote Enclosure with Cover Removed - ADVANCED	
	Figure 9.VRF II Series - Remote Connection Diagram	

VI. SET-UP	14
Operation	
Pro-Guard®	
Product Overview - STANDARD	
Figure 10. Switch Functions	
Product Overview - ADVANCED	
Figure 11. Switch Functions	
Fail-Safe Selection	
Time Delay Settings - STANDARD	
Time Delay Settings - ADVANCED	
Sensitivity Settings - STANDARD	
Sensitivity Settings - ADVANCED	
Calibration - Automatic	
Calibration - Manual - ADVANCED ONLY	
Calibration - Test - ADVANCED ONLY	
Figure 12. Magnetic Fob	
VII. MAINTENANCE	20
VIII. TROUBLESHOOTING	21

SAFETY SYMBOLS



WARNING:

IDENTIFIES CONDITIONS OR PROCEDURES, WHICH IF NOT FOLLOWED, COULD RESULT IN SERIOUS INJURY. RISK OF ELECTRICAL SHOCK.



CAUTION:

IDENTIFIES CONDITIONS OR PROCEDURES, WHICH IF NOT FOLLOWED, COULD RESULT IN SERIOUS DAMAGE OR FAILURE OF THE EQUIPMENT.

VRF® II Series Installation & Operation Manual

I. HANDLING AND STORAGE

SAVE THESE INSTRUCTIONS

INSPECTION AND HANDLING

Do not dispose of the carton or packing materials.

Each package should be inspected upon receipt for damage that may have occurred due to mishandling during shipping. If the unit is received damaged, notify the carrier or the factory for instructions. Failure to do so may void your warranty. If you have any problems or questions, consult Customer Support at 800-778-9242.

DISPOSAL AND RECYCLING

This product can be recycled by specialized companies and must not be disposed of in a municipal collection site. If you do not have the means to dispose of properly, please contact for return and disposal instructions or options.

STORAGE

If the device is not scheduled for immediate installation following delivery, the following steps should be observed:

1. Following inspection, repackage the unit into its original packaging.
2. Select a clean dry site, free of vibration, shock and impact hazards.
3. If storage will be extended longer than 30 days, the unit must be stored at temperatures between 32° and 158° F (0° to 70° C) in non-condensing atmosphere with humidity less than 85%.



CAUTION: DO NOT STORE A NON-POWERED UNIT OUTDOORS FOR A PROLONGED PERIOD.

II. GENERAL SAFETY



WARNING: ONLY CERTAIN MODELS CAN BE USED IN HAZARDOUS LOCATIONS; SEE NAMEPLATE. THESE MODELS SHALL ONLY BE USED IN APPLICATIONS COVERED BY THE STATED RATINGS OR NON-HAZARDOUS LOCATIONS.

AUTHORIZED PERSONNEL

All instructions described in the document must be performed by authorized and qualified service personnel only. Before installing the unit, please read these instructions and familiarize yourself with the requirements and functions of the device. The required personal protective equipment must always be worn when servicing this device.

USE

The device is solely intended for use as described in this manual. Reliable operation is ensured only if the instrument is used according to the specifications described in this document. For safety and warranty reasons, use of accessory equipment not recommended by the manufacturer or modification of this device is explicitly forbidden. All servicing of this equipment must be performed by qualified service personnel only. This device should be mounted in locations where it will not be subject to tampering by unauthorized personnel.

MISUSE

Improper use or installation of this device may cause the following:

- Personal injury or harm
- Application specific hazards such as vessel overfill
- Damage to the device or system

If any questions or problems arise during installation of this equipment, please contact Customer Support at 800-778-9242.

III. PRODUCT DESCRIPTION

FUNCTION

The VRF® II Series is a point level sensor used to detect the presence or absence of material at a point inside a tank, bin, or other vessel. Material coming in contact with the unit's probe causes its output relay to change state, thereby indicating the presence of material.

Operation of the VRF II Series is based upon the Bindicator® Opti-Sense™ technology to measure changes in the impedance of the unit's probe with respect to the ground. At the heart of the unit is a network analyzer with a built in DSP (Digital Signal Processor) that continuously monitors the probe's impedance (capacitance, resistance, and inductance) with respect to ground. When there is a large enough change in the impedance, the status of the output relay changes to indicate the presence or absence of the material.

APPLICATIONS

This model is ideal for the point level detection of dry bulk materials, liquids, and slurries. It is not appropriate for conductive materials that will coat, or build up on the probe. It is ideal in the measurement of materials with a dielectric constant as low as 1.2. Moisture content and bulk density also factor into the unit's ability to sense low dielectric materials. Call the manufacturer Applications Department with questions.

FEATURES

- Multiple mounting configurations and probes are available to suit almost any application

- Universal input power; AC or DC (see specifications for input ranges)

- Pro-Guard® probe design

- Automatic calibration EZ-CAL™ II

- Adjustable time delay

- Selectable fail-safe operation (high or low level)

- Adjustable Sensitivity

TECHNICAL SPECIFICATIONS

FUNCTIONAL	
Power Requirements Universal	(± 10%), 120-240 VAC 50/60 Hz or 24-48 VDC
Power Consumption - STANDARD	3 W AC; 3 W DC
Power Consumption - ADVANCED	4 W AC; 4 W DC
Fuse	Fast Blow, 1A 300 VAC (Not User Serviceable)
Operating Temperature	
Electronics	-40° to 158° F (-40° to 70° C)
Probe	-40° to 993° F (-40° to 534° C) depending on probe
Outputs	
Main Relay	8 A DPDT @ 240 VAC or 30 VDC (resistive)
Auxiliary Relay - ADVANCED ONLY	0.46 A SPDT @ 150 VAC or 1 A @ 30 VDC
PERFORMANCE	
Pressure Rating	150 psi (10.5 kg/cm ²) with 3/4" NPT; 50 psi (3.5 kg/cm ²) with 1 1/4" NPT
Time Delay - STANDARD	Field Adjustable; 0.2-6 seconds
Time Delay - ADVANCED	Field Adjustable; 0-150 seconds
Fail Safe	Field Selectable; high/low level
Sensitivity - STANDARD	Field Adjustable; minimum 1.5 pf
Sensitivity - ADVANCED	Field Adjustable; minimum 0.5 pf
Maximum Particle Size	9/16" (14.3 mm)
PHYSICAL	
Enclosure Material	Polyester or Epoxy Coated Aluminum or 304 SS
Dual Conduit Entry	3/4" NPT or M20 x 1.5
Extended Pipe Material	Galvanized or 316 SS
Shipping Weight	Integral, non-extended 10 lb (4.5 kg)
Pollution Degree	2
Installation Category	II
Altitude	6,562 ft (2,000 m)

APPROVALS & RATINGS

UL (US and Canada):

Ordinary Location Type 4X; IP66
 Hazardous Location, Type 4X
 Explosion Proof
 Dust Ignition Proof

CE

Electromagnetic Compatibility Directive
 Low Voltage Directive

3A SANITARY

IV. MECHANICAL INSTALLATION



WARNING: WARNING: REMOVE POWER FROM THE UNIT BEFORE INSTALLING, REMOVING, OR MAKING ADJUSTMENTS.



WARNING: IN ORDER TO MAINTAIN SAFE OPERATION IN HAZARDOUS LOCATIONS, THE INTEGRITY OF THE ALUMINUM CASTING AND THE EPDM SEALS MUST BE MAINTAINED. THE USER/INSTALLER MUST AVOID INSTALLATIONS WHERE AGGRESSIVE SUBSTANCES MAY BE PRESENT AND COULD AFFECT THE PERFORMANCE OF THESE MATERIALS. CARE MUST BE EXERCISED WHEN REMOVING AND REPLACING THE COVER, SO NO MARRING, SCRATCHING OR DAMAGE OCCURS TO THE FLANGES.



WARNING: FOR UNITS INSTALLED IN HAZAROUS LOCATIONS, TO REDUCE THE RISK OF IGNITION OF HAZARDOUS ATMOSPHERES, CONDUIT RUNS MUST HAVE A SEALING FITTING CONNECTING WITHIN 18 IN. OF THE ENCLOSURE.



WARNING: FOR PRODUCTS MARKED AS TYPE 4X, USE TYPE 4X HUB FITTING; FOR IP66 USE IP66 HUB FITTING.



WARNING: MOUNT PROBE SO THAT THE PRO-GUARD® SECTION OF THE PROBE IS FULLY IN THE TANK OR CHUTE WHERE LEVEL OF PRODUCT WILL COME AND GO FROM IT.



WARNING: INTERNAL AMBIENT TEMPERATURE MUST NOT EXCEED 80°C IN ORDER TO NOT COMPROMISE INTRINSICALLY-SAFE PROTECTION.



CAUTION: WHEN MOUNTING UNITS, NEVER ADJUST THE ORIENTATION BY TURNING THE HOUSING. USE 2-1/4 IN. WRENCH FOR PROCESS FITTING UNITS, OTHERWISE A STRAP WRENCH SHOULD BE USED TO TIGHTEN INTO PLACE.



CAUTION: WHETHER MOUNTING DIRECTLY THROUGH A SIDE WALL, OR PIPE EXTENDED AND MOUNTED VERTICALLY THROUGH THE TOP OF A VESSEL, NEVER ATTEMPT TO MOUNT THROUGH A FULL COUPLING.

GUIDELINES

The following precautions should be observed when installing and operating the VRF II Series units:

- The installation and wiring of this product must comply with all national, federal, state, municipal and local codes that apply.
- The VRF II Series is a precision device - handle it carefully to prevent damage to the probe.
- Do not allow moisture to enter the electronics enclosure. Conduit should slope downward from the VRF II Series housing. Install drip loops (or drain fitting) and seal conduit with silicone rubber product.

MOUNTING CONSIDERATIONS

The VRF II Series must be located at the position where level indication is desired. The probes may be mounted through the top or side wall of the vessel. To ensure reliable operation, observe the following guidelines when choosing the mounting location.

- Do not mount the probe directly in the flow of material.
- Do not mount the probe in an area where it can contact the vessel.
- In installations where there are multiple probes, do not mount the probes within 12 inches (30.5 cm) of each other.
- If probes will be tip extended, contact factory for further instructions.
- Remote cable, between probe and electronics, cannot exceed 100 feet (30.5 m).
- If necessary, use a baffle to protect the probe from falling material. The baffle should be placed 6 to 8 inches (15 to 20 cm) above the probe so that material will not become packed.

Figure 1. Mounting In Relation To Flow of Material

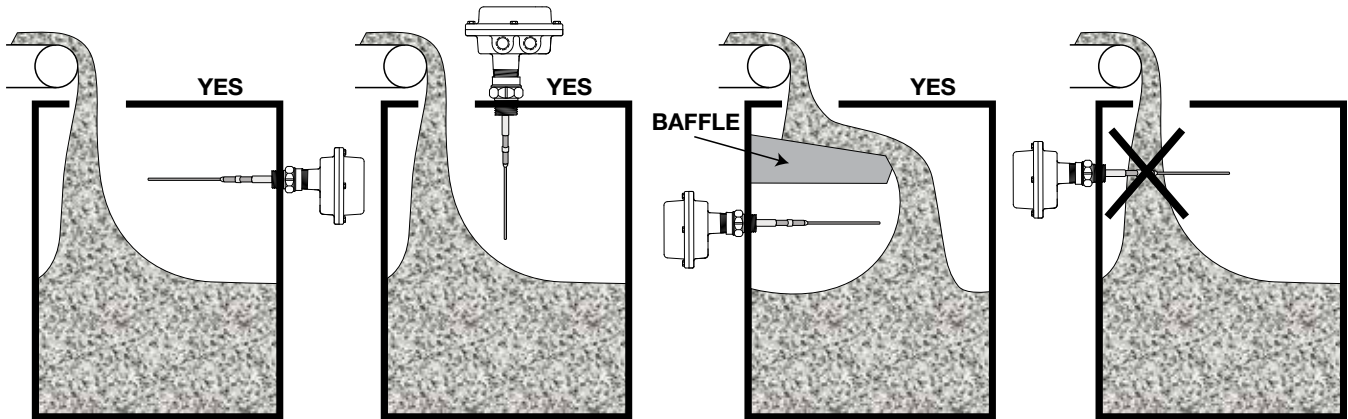

V. ELECTRICAL INSTALLATION



WARNING: REMOVE POWER FROM THE UNIT BEFORE INSTALLING, REMOVING, OR MAKING ADJUSTMENTS.



WARNING: FOR UNITS INSTALLED IN HAZAROUS LOCATIONS, TO REDUCE THE RISK OF IGNITION OF HAZARDOUS ATMOSPHERES, CONDUIT RUNS MUST HAVE A SEALING FITTING CONNECTING WITHIN 18 IN. OF THE ENCLOSURE.



WARNING: FOR PRODUCTS MARKED AS TYPE 4X, USE TYPE 4X HUB FITTING; FOR IP66 USE IP66 HUB FITTING.



WARNING: INTERNAL AMBIENT TEMPERATURE MUST NOT EXCEED 80°C IN ORDER TO NOT COMPROMISE INTRINSICALLY-SAFE PROTECTION.



CAUTION: IF THE UNIT WAS SUPPLIED WITH A GASKET, AVOID FOLDING, CUTTING OR TEARING THE GASKET. DAMAGING THE GASKET CAN ALLOW MOISTURE TO ENTER THE ENCLOSURE AND DAMAGER THE UNIT



CAUTION: TO REDUCE THE RISK OF IGNITION IN HAZARDOUS ATMOSPHERES, DISCONNECT THE EQUIPMENT FROM SUPPLY CURCIUT BEFORE OPENING. KEEP ASSEMBLY TIGHTLY CLOSE WHEN IN OPERATION.

GENERAL SAFETY

When using electrical equipment, you should always follow basic safety precautions, including the following:

- The installation and wiring of this product must comply with all national, federal, state, municipal, and local codes that apply.
- Properly ground the enclosure to an adequate earth ground.
- Do not modify any factory wiring. Connections should only be made to the terminals described in this section.
- All connections to the VRF II Series must use conductors with an insulation rating of 300V minimum, rated for 212° F (105° C), a minimum flammability rating of VW-1, and be of appropriate gauge for the voltage and current required (see specifications).
- Do not allow moisture to enter the electronics enclosure. Conduit should slope downward from the VRF II Series housing. Install drip loops and seal conduit with silicone rubber product.

DISCONNECT REQUIREMENTS FOR PERMANENTLY INSTALLED EQUIPMENT

A dedicated disconnecting device (circuit breaker) must be provided for the proper installation of the unit. If independent circuits are used for power input and main relay outputs, individual disconnects are required.

Disconnects must meet the following requirements:

- Located in close proximity to the device
- Easily accessible to the operator
- Appropriately marked as the disconnect for the device and associated circuit

- Sized appropriately to the requirements of the protected circuit (See Specifications)

PROTECTIVE EARTH GROUND

To eliminate shock hazards in the unlikely event of an internal insulation breakdown, the unit is provided with an “earth” lead which must be connected to earth ground. In addition, the input power ground lead must be connected to the “protective earth” () terminal provided. Wire sizes must be selected such that it can safely carry the sum total of all circuits’ maximum amperage.

CONDUIT-CABLE CONNECTION

Two threaded female conduit openings are provided in the housing for input and output wiring. When only one conduit opening is used for installation, the unused opening must be sealed with a suitable type 4X/IP66 plug with pipe sealant in order to maintain approval requirements.

ELECTRICAL CONNECTIONS

Note: The VRF II Series can be operated from 120-240 VAC 50/60 Hz or 24-48 VDC and provides reverse polarity protection in the event of a wiring error.

VRF II SERIES INTEGRAL MODEL ONLY

1. Connect the provided protective earth ground to earth ground on the vessel

Input Power Connections

2. Refer to Figures 3 or 4 and 5 when connecting input power to the unit.
3. Loosen the housing cover screws and remove cover, 1/4-20 screw (7/16” driver). Metric: M8 x 1.25 hex head.



CAUTION: IF THE UNIT WAS SUPPLIED WITH A GASKET AVOID FOLDING, CUTTING OR TEARING GASKET. DAMAGING THE GASKET CAN ALLOW MOISTURE TO ENTER THE ENCLOSURE AND DAMAGE THE UNIT.

Note: Two threaded female conduit openings are provided in the housing to separate input and output wiring.

4. Pull approximately 4” of cable through conduit closest to the grounding bracket and strip as follows:
 - a. Ground – 3/8” (9 to 10 mm)
 - b. Power Leads – 1/4” (6 to 7 mm)
5. Attach incoming ground lead to grounding bracket as shown in Figure 3 or 4.

Note: The VRF II Series incorporates pluggable terminal blocks for ease of connection. If the terminal block is unplugged while making connections, ensure it is seated properly when reinstalled.

6. Attach power leads to terminal block as shown in Figure 5.
7. Check that all wires are held tightly in place by lightly pulling each conductor.

Main Relay Connections

8. Refer to Figure 3 or 4 and 6 when connecting to the main relay.
9. Pull approximately 4.5" (11.43 cm) of cable through conduit and strip 1/4" (6 to 7 mm).
10. Attach leads to terminal block as shown in Figure 5.
11. Check that all wires are held tightly in place by lightly pulling each conductor.

For STANDARD models skip to Step 16; for ADVANCED models continue to Step 12.

Auxiliary Relay Connections

12. Refer to Figure 3 or 4 and 7 when connecting to the auxiliary relay.
13. Pull approximately 5.5" (13.97 cm) of cable through conduit and strip 1/4" (6 to 7 mm).
14. Attach leads to terminal block as shown in Figure 5.
15. Check that all wires are held tightly in place by lightly pulling each conductor.
16. Reinstall the gasket, if necessary.
17. Replace cover and tighten screws to 60 in-lb (6.8 n-m) of torque.

VRF II SERIES REMOTE MODEL ONLY

1. Connect the provided external protective earth ground to earth ground on the vessel.

Input Power Connections

2. Refer to Figures 3 or 4 and 5 when connecting input power to the unit.
3. Loosen set screw that locks cover in place, 1/4-20 screw (7/16" driver). Metric: M8 x 1.25 hex head.
4. Unscrew the housing cover and remove.

Note: Two threaded female conduit openings are provided in the remote housing to separate input and output wiring from the remote probe wiring.

5. Pull approximately 6" (15 cm) of cable through conduit closest to grounding bracket and strip as follows:
 - a. Ground – 3/8" (9 to 10 mm)
 - b. Power Leads – 1/4" (6 to 7 mm)
6. Attach incoming ground lead to grounding bracket as shown in Figure 5.

Note: The VRF II Series incorporates pluggable terminal blocks for ease of connection. If the terminal block is unplugged while making connections, ensure it is seated properly when reinstalled.

7. Attach power leads to terminal block as shown in Figure 3 or 4.
8. Check that all wires are held tightly in place by lightly pulling each conductor.

Main Relay Connections

9. Refer to Figure 3 or 4 and 6 when connecting to the main relay.
10. Pull approximately 9" (23 cm) of cable through conduit and strip 1/4" (6 to 7 mm).
11. Attach leads to terminal block as shown in Figure 3 or 4.

12. Check that all wires are held tightly in place by lightly pulling each conductor.

Auxiliary Relay Connections - ADVANCED ONLY

13. Refer to Figure 3 or 4 and 7 when connecting to the auxiliary relay.
14. Pull approximately 2.5" (6 cm) of cable through conduit and strip $\frac{1}{4}$ " (6 to 7 mm).
15. Attach leads to terminal block as shown in Figure 7.
16. Check that all wires are held tightly in place by lightly pulling each conductor.

Remote Probe Connections

17. Refer to Figure 8 or 9 and 10 when connecting the remote probe.
18. Pull approximately 2.5" (6 cm) of cable through conduit and strip $\frac{3}{16}$ " (4 to 5 mm).
19. Connect factory supplied cable to terminals block as shown in Figure 10.
20. Check that all wires are held tightly in place by lightly pulling each conductor.
21. Replace cover.
22. Tighten set screw to lock cover in place.
23. Loosen the remote probe housing cover screws and remove cover.



CAUTION: IF THE UNIT WAS SUPPLIED WITH A GASKET AVOID FOLDING, CUTTING, OR TEARING GASKET. DAMAGING THE GASKET CAN ALLOW MOISTURE TO ENTER THE ENCLOSURE AND DAMAGE THE UNIT.

24. Pull approximately 4" (10 cm) of cable through conduit and strip $\frac{3}{16}$ " (4 to 5 mm).
25. Connect factory supplied cable to terminals block as shown in Figure 3 or 4.
26. Check that all wires are held tightly in place by lightly pulling each conductor.
27. Reinstall the gasket, if necessary.
28. Replace cover and tighten screws to 60 in-lb (6.8 n-m) of torque.

Figure 2. VRF II Series: Integral Enclosure with Cover Removed - STANDARD

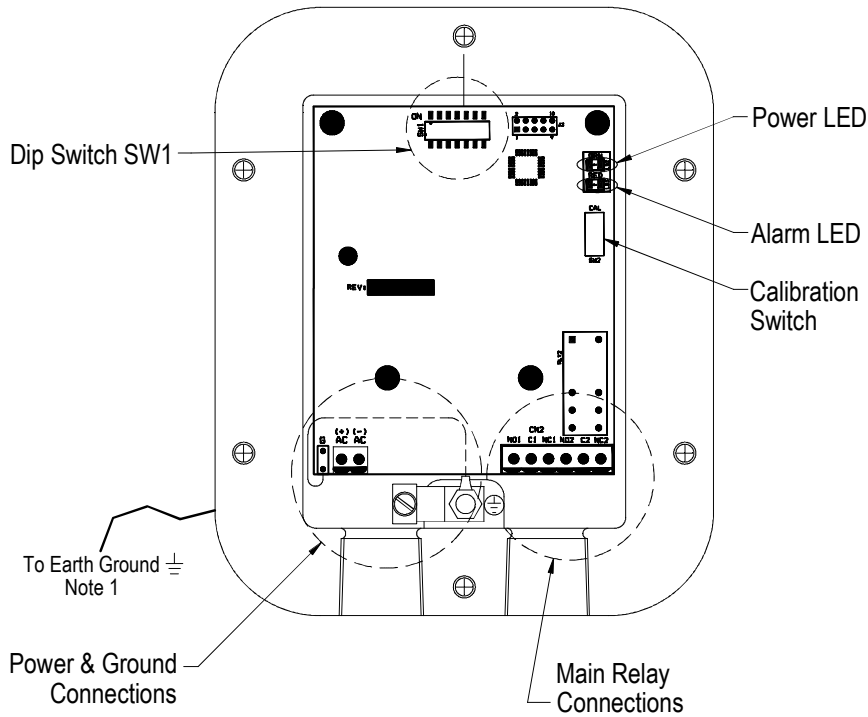

Notes:

- 1) For Safety and to insure Proper Operation, Attach Ground Wire to an Adequate Earth Ground.

Figure 3. VRF II Series: Integral Enclosure with Cover Removed - ADVANCED

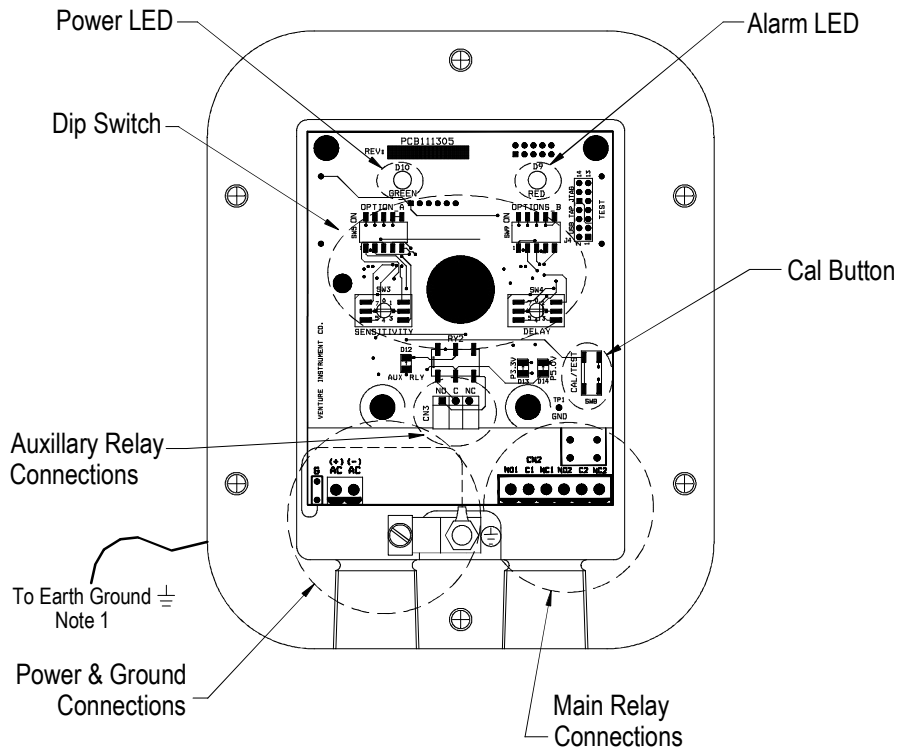

Notes:

- 1) For Safety and to insure Proper Operation, Attach Ground Wire to an Adequate Earth Ground.

Figure 4. Power and Ground Connections

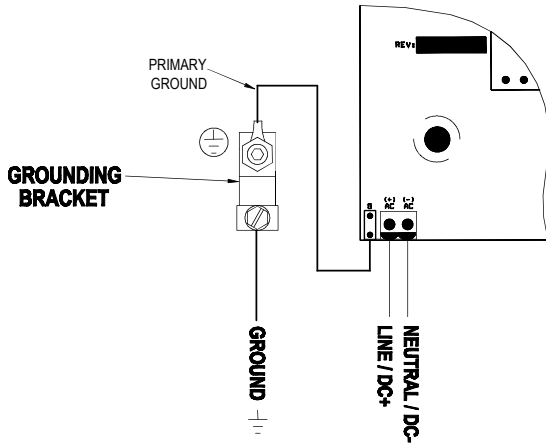

Figure 5. Main Relay Connections

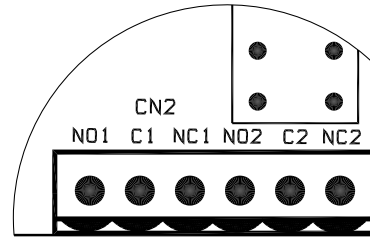

Figure 6. Auxiliary Relay Connections - ADVANCED ONLY

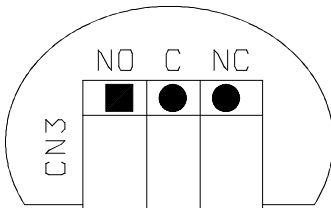
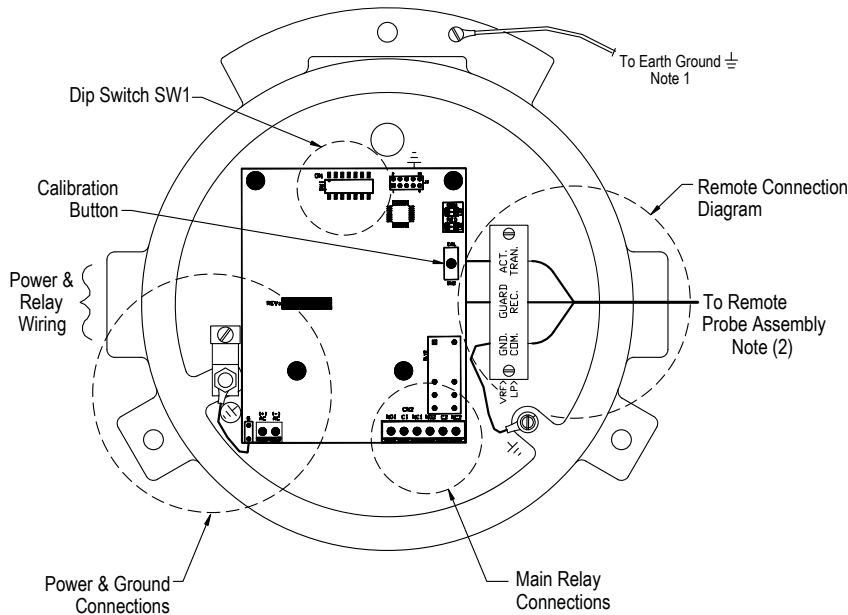

Figure 7. VRF II Series Remote Enclosure with Cover Removed - STANDARD



Notes:

- 1) For Safety and to insure Proper Operation, Attach Ground Wire to an Adequate Earth Ground.
- 2) Wiring Between Probe & Electronics must be per Drawing SK50085, and Run Through Dedicated Metallic Conduit.

Figure 8. VRF II Series Remote Enclosure with Cover Removed - ADVANCED

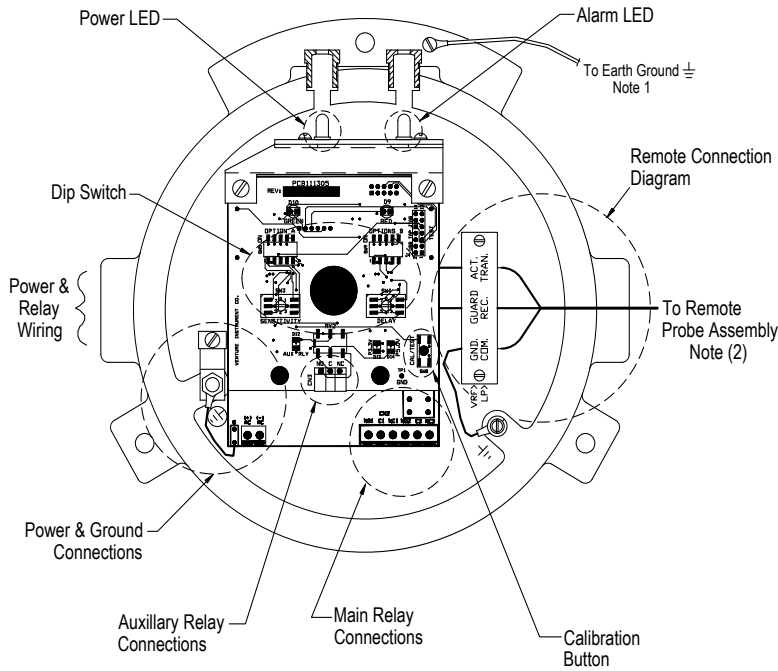

- Notes:
- 1) For Safety and to insure Proper Operation, Attach Ground Wire to an Adequate Earth Ground.
 - 2) Wiring Between Probe & Electronics must be per Drawing SK50085, and Run Through Dedicated Metallic Conduit.

Figure 9. VRF II Series - Remote Connection Diagram

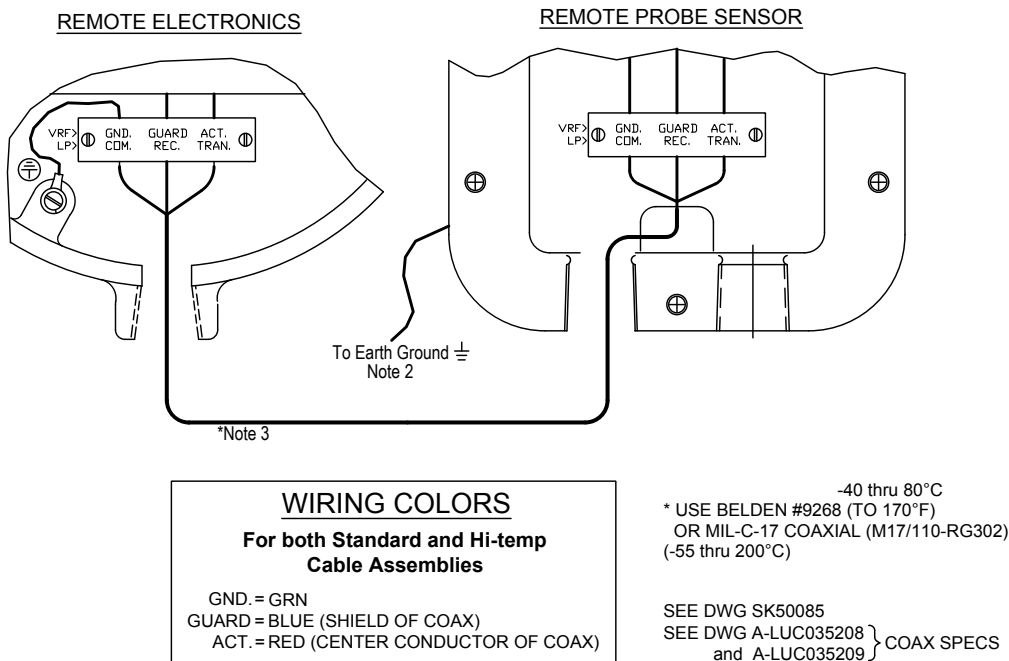

- Notes:
- 1) Maximum cable length is 100ft.
 - 2) For Safety and to insure Proper Operation, Attach Ground Wire to an Adequate Earth Ground.
 - 3) Interconnecting Cable Must be run in Dedicated Metallic Conduit.

VI. SET-UP



WARNING: REMOVE POWER FROM THE UNIT BEFORE INSTALLING, REMOVING OR MAKING ADJUSTMENTS.



CAUTION: TO REDUCE THE RISK OF IGNITION IN HAZARDOUS ATMOSPHERES, DISCONNECT THE EQUIPMENT FROM SUPPLY CURCIUT BEFORE OPENING. KEEP ASSEMBLY TIGHTLY CLOSE WHEN IN OPERATION.

OPERATION

The VRF II Series will begin operating and the green Power LED will be illuminated when power is applied. Once properly installed, the VRF II Series should be calibrated (refer to Calibration Section) when material is below the probe. The status of the red Alarm LED is determined by the selected fail-safe mode and whether or not the probe is in material. Refer to Fail-Safe Operation section. If the unit is calibrated prior to its final installation or if it is moved from one installation to another, recalibration is required.

PRO-GUARD®

The VRF II Series has the ability to ignore the effects of coatings that can adhere to the sensing probe. In most applications, a certain amount of material that is being sensed will adhere to the sensing probe after a period of time. This can be due to the nature of the material itself or condensed moisture that can cause dry material to bond to the probe's surface.

Pro-Guard allows the VRF II Series to disregard the effects of probe coating and only indicates that material is present when the actual bulk material (either dry or liquid) comes in contact with the probe.

The drive current to the Pro-Guard electrode is at the same frequency and polarity as the probe. When a coating forms on the probe, the VRF II Series current from the Pro-Guard tends to saturate that portion of the built up material near the wall so that little or no current can flow from the probe to the wall. When the actual bulk material in the vessel fills to the point where it touches the probe, current from the probe will flow around the saturated region and indicate material presence.

PRODUCT OVERVIEW - STANDARD

Figures 3 and 8 show the electronics of the integral and remote versions of the VRF II Series respectively. The figures show the location of the electrical connections, dip switches SW1, and the Power and Alarm LEDs. The settings of the VRF II Series are controlled by SW1 as shown in Figure 11.

Figure 11: Switch Functions

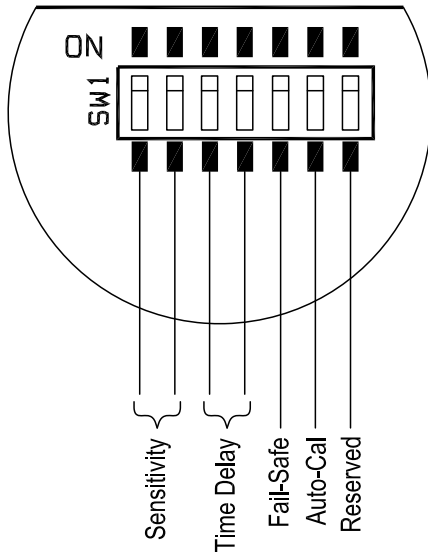

PRODUCT OVERVIEW - ADVANCED

Figures 3 and 8 show the electronics of the integral and remote versions of the VRF II Series respectively. The figures show the location of the electrical connections, dip switches SW5, two rotary switches SW3 and 4, and the Power and Alarm LEDs. The settings of the VRF II Series are controlled by SW3 through 5 as shown in Figure 10.

Figure 10: Switch Functions

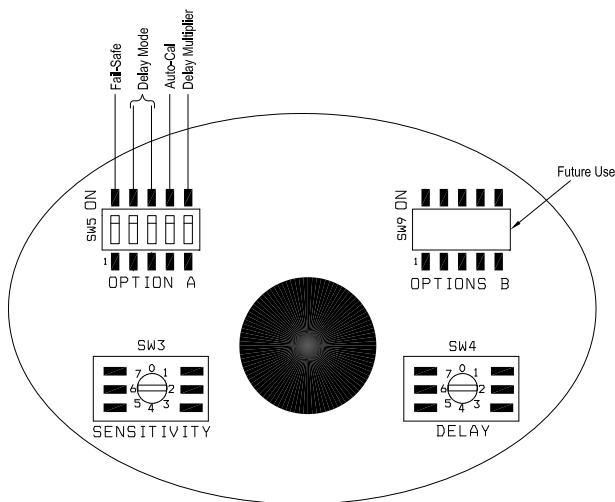

FAIL-SAFE SELECTION

The VRF II Series models are factory set for high level fail-safe operation. The Fail-Safe is controlled by SW1, position 5.

HIGH LEVEL FAIL-SAFE OPERATION (DEFAULT)

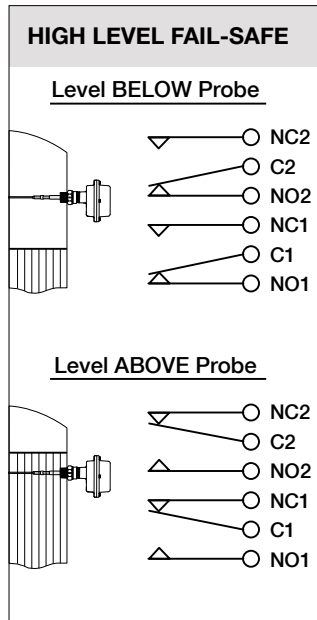

DIP Switch

- STANDARD: SW1-5 is OFF
- ADVANCED: SW5-1 is OFF

Non-Alarm State (material below the probe)

- Main Relay is energized
 - Relay NC contacts are open
 - Relay NO contacts are closed
- Alarm LED is OFF

Alarm State (material above the probe)

- Main Relay is de-energized
 - Relay NC contacts are closed
 - Relay NO contacts are open
- Alarm LED is ON

Note: If the electrical power fails, the main relay turns OFF, giving the same indication as if material is above the probe.

LOW LEVEL FAIL-SAFE OPERATION

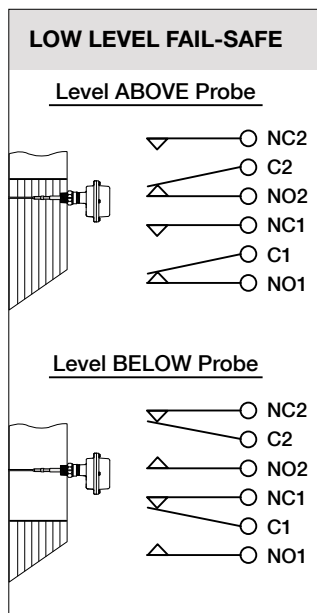

DIP Switch

- STANDARD: SW1-5 is ON
- ADVANCED: SW5-1 is ON

Non-Alarm State (material above the probe)

- Main Relay is energized
 - Relay NC contacts are open
 - Relay NO contacts are closed
- Alarm LED is OFF

Alarm State (material below the probe)

- Main Relay is de-energized
 - Relay NC contacts are closed
 - Relay NO contacts are open
- Alarm LED is ON

Note: If the electrical power fails, the main relay turns OFF, giving the same indication as if material is below the probe.

TIME DELAY SETTINGS - STANDARD

This setting will delay the time between when the VRF II Series senses material and the main relay changes state. The delay is only in this direction, regardless of fail-safe setting. There is no added delay when the material leaves the probe. There is a fixed internal delay when material leaves the probe and this delay varies from 1 to 3 seconds as the sensitivity is changed from lowest sensitivity (high vibration) to high sensitivity (lowest vibration). Duration of an additional delay is determined by SW1 Positions 3, and 4 as described in the table below. The VRF II Series is factory set for the minimum delay.

SW1 Position 3	SW1 Position 4	Delay (seconds)
OFF	OFF	1-3
OFF	ON	1
ON	OFF	3
ON	ON	6

TIME DELAY SETTINGS - ADVANCED

The time between when the VRF II Series senses material, or its absence, and the output relay changes state is field programmable using SW5 positions 2 & 3. The delay can be in either or both directions, regardless of the fail-safe setting. Duration of the delay is determined by SW4 and SW5 position 5. The functionality of each switch is shown in the tables below.

SW5 Position 2	Delay Mode
ON	The selected delay by the SW4 is applied when material touches the probe
OFF	There is no delay when material touches the probe
SW5 Position 3	Delay Mode
ON	The selected delay by the SW4 is applied when material leaves the probe
OFF	There is no delay when material leaves the probe

The duration of the delay is determined by SW4 in conjunction with SW5-5. When active, SW5-5 multiplies the delay by a factor of 5. The functionality of each switch is shown in the tables below.

SW4	SW5 Position 5	Delay Time (seconds)
0	OFF	1-3 (see Note)
1	OFF	1
2	OFF	3
3	OFF	4
4	OFF	6
5	OFF	9
6	OFF	18
7	OFF	30
0	ON	1-3 (see Note)
1	ON	5
2	ON	15
3	ON	20
4	ON	30
5	ON	45
6	ON	90
7	ON	150

SENSITIVITY SETTINGS - STANDARD

There are four different sensitivity ranges on the VRF II Series that can be selected using SW1 Position 1 and 2. The unit is factory set to 5.0 pf sensitivity.

SW1 Position 1	SW1 Position 2	Pico Farad
OFF	OFF	1.5 (Highest Sensitivity)
OFF	ON	3.0
ON	OFF	5.0
ON	ON	10.0

SENSITIVITY SETTINGS - ADVANCED

The VRF II Series provides seven (7) levels of sensitivity which are selected using SW3 as shown in the table below. The units is factory set to 3.0 pf sensitivity.

SW3	Pico Farad
0	0.5 (Highest Sensitivity)
1	1.0
2	1.5
3	2.0
4	3.0
5	5.0
6	8.0
7	10.0

CALIBRATION - AUTOMATIC

The VRFII Series are shipped from factory with the auto calibration feature enabled. After installation and wiring of the unit, there is a need to initiate calibration either by pressing the CAL button internally or the use of FOB (Advanced Unit only) externally. This is required to activate the auto calibration feature of the VRFII.

There will be two possible scenarios:

- If the unit is installed with material touching the VRFII probe the unit will recalibrate as soon as the material starts leaving the probe. This process of recalibration continues until the unit recalibrates itself to air (lowest dielectric). After recalibration to air, the auto recalibration stops until another calibration is initiated.
- If the unit is installed with no material present then the calibration only calibrates the unit to air and its new environment. In this case auto calibration cycle occurs only once.

During recalibration (Auto Cal) the green and red LEDs will alternatively turn on and off to indicate recalibration process.

If auto calibration is not desired (High Dielectric Materials) then set SW1-6 on the Standard unit or SW5-4 on Advanced unit to off position. Please note that if the unit is calibrated in material with Auto Cal switch in off position, then upon material leaving the probe green LED and AUX relay will turn off, this is an indication of a negative impedance (out of calibration). Manually re-calibrating at this point will correct this issue.

CALIBRATION - MANUAL

The Advanced units can be calibrated manually by pressing the CAL/TEST button SW8 or externally using magnetic FOB provided with the unit. The Standard unit can only be calibrated by pressing the CAL button SW2.

During calibration the green and red LEDs will alternately turn on and off to indicate calibration process.

TEST - ADVANCED ONLY

The VRF II Series provides a means for self-test using the magnetic FOB provided with the unit. When the unit is not in material, place and hold the FOB over the "TEST" label on the cover. If the unit is functioning properly, the alarm LED and main relay will change the state as shown below. When the test is completed and results verified, simply move the FOB away from the unit.

HIGH FAIL-SAFE:

- Main relay de-energizes
- Red ALARM LED is on

LOW FAIL-SAFE

- Main relay energizes
- Red ALARM LED is off

Figure 12: Magnetic FOB

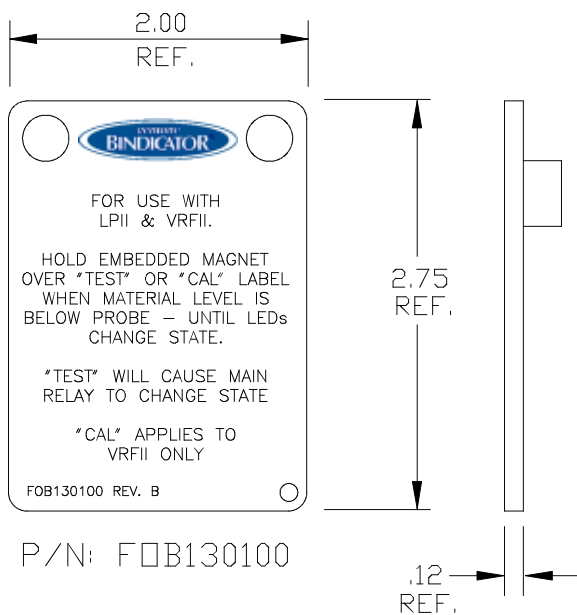

VII. MAINTENANCE



WARNING: TO AVOID IGNITION HAZARD DUE TO ELECTROSTATIC DISCHARGE, CLEAN ONLY WITH A DAMP CLOTH.



WARNING: IN ORDER TO MAINTAIN SAFE OPERATION IN HAZARDOUS LOCATIONS, THE INTEGRITY OF THE ALUMINUM CASTING AND THE EPDM SEALS MUST BE MAINTAINED. THE USER/INSTALLER MUST AVOID INSTALLATIONS WHERE AGGRESSIVE SUBSTANCES MAY BE PRESENT AND COULD AFFECT THE PERFORMANCE OF THESE MATERIALS. CARE MUST BE EXERCISED WHEN REMOVING AND REPLACING THE COVER, SO NO MARRING, SCRATCHING OR DAMAGE OCCURS TO THE FLANGES.



CAUTION: IF THE UNIT WAS SUPPLIED WITH A GASKET, AVOID FOLDING, CUTTING OR TEARING THE GASKET. DAMAGING THE GASKET CAN ALLOW MOISTURE TO ENTER THE ENCLOSURE AND DAMAGER THE UNIT

PREVENTATIVE MAINTENANCE

No scheduled preventative maintenance is required for the VRF II Series units when properly applied and installed correctly. There is no cleaning required for the unit before or during installation.

If the cover is removed after the unit has been in service, it is recommended to replace the gasket to prevent the ingress of water or dust. At a minimum, the gasket (or o-ring, used in hazardous locations) should be inspected for folds, cracks and tears.

If the unit is a 3A Sanitary approved configuration, it requires CIP cleaning; Clean In Place (CIP) requires the removal of soil from product contact surfaces in their process position by circulating, spraying, or flowing chemical solutions and water rinses onto and over the surfaces to be cleaned. Components of the equipment, which are not designed to be cleaned in place, are removed from the equipment to be COP (Cleaned Out of Place) or manually cleaned. Product contact surfaces to be CIP cleaned are inspectable, except as specified in E1.4.2.1 of the 3A Sanitary Standards.

VIII. TROUBLESHOOTING

Advanced units have an AUX relay RY2 that is used as a status relay. This relay is normally energized when the unit is powered and operates normally in case of any operation issues this relay is de-energized to signal abnormal operation status of the unit. The contacts of this relay are available through CN3 to be wired to signal the status of the Advanced unit.

	SYMPTOM	POSSIBLE CAUSE	SOLUTION
Auxiliary Relay is De-energized Or unit does not function	No Power to the unit	No LED on the board is illuminating	<ul style="list-style-type: none"> • Check Power at CN1 terminals • If correct power is present then unit is damaged, replace electronic.
	Unit lost Calibration	Both Red and Green LEDs are off but other LEDs on the board are illuminating	<ul style="list-style-type: none"> • Manually calibrate the Unit in air (no material) or • Turn Auto Calibration switch on and then manually calibrate the unit to activate the auto cal.
	Units Malfunction	Unit does not react but LEDs are illuminating	<ul style="list-style-type: none"> • Too much accumulation of materials on the probe • Probe is damaged • Electronic failure

Note: Standard units do not have Auxiliary relay



150 Venture Boulevard
Spartanburg, SC 29306
Tel: (800) 778-9242
Fax: (864) 574-8063
sales@bindicator.com
www.bindicator.com

venture
MEASUREMENT

2014 All rights reserved.
All data subject to change without notice.

VRF180913 Rev D