

# PDA1500 High Voltage AC/DC to Logic Level Converter Instruction Manual



- Combine with the Vigilante® II Annunciator to Monitor High Voltages
- Four High Voltage Inputs Up to 265 VAC or VDC
- Four Digital 5 VDC Outputs
- Easy DIN Rail Mounting
- Simple Two-Button Setup
- Cascade Mode for Series Break Configurations
- Multi-Unit Cascade Mode

Order from:

**C A Briggs Company**

622 Mary Street; Suite 101

Warminster, PA 18974

Phone: 267-673-8117 - Fax: 267-673-8118

[Sales@cabriggs.com](mailto:Sales@cabriggs.com) - [www.cabriggs.com](http://www.cabriggs.com)

**PRECISION DIGITAL CORPORATION**

89 October Hill Road • Holliston MA 01746 USA

Tel (800) 343-1001 • Fax (508) 655-8990



[www.predig.com](http://www.predig.com)

## Disclaimer

The information contained in this document is subject to change without notice. Precision Digital makes no representations or warranties with respect to the contents hereof and specifically disclaims any implied warranties of merchantability or fitness for a particular purpose.



### CAUTION

*Read complete instructions prior to installation and operation of the meter.*



### WARNING

*Risk of electric shock or personal injury.*



### Warning

***This product is not recommended for life support applications or applications where malfunctioning could result in personal injury or property loss. Anyone using this product for such applications does so at his/her own risk. Precision Digital Corporation shall not be held liable for damages resulting from such improper use.***

## Limited Warranty

Precision Digital Corporation warrants this product against defects in material or workmanship for the specified period under "Specifications" from the date of shipment from the factory. Precision Digital's liability under this limited warranty shall not exceed the purchase value, repair, or replacement of the defective unit.

## Registered Trademarks

PROVu<sup>®</sup> and Vigilante<sup>®</sup> are a registered trademarks of Precision Digital Corporation. All other trademarks mentioned in this document are the property of their respective owners.

© 2014 Precision Digital Corporation. All rights reserved.

**[www.predig.com](http://www.predig.com)**

## Table of Contents

<b>INTRODUCTION</b>	<b>5</b>
<b>ORDERING INFORMATION</b>	<b>5</b>
<b>SPECIFICATIONS</b>	<b>6</b>
General	6
<b>SAFETY INFORMATION</b>	<b>8</b>
<b>INSTALLATION</b>	<b>8</b>
Unpacking	8
<b>DIN Rail Mounting Instructions</b>	<b>9</b>
DIN Rail Mounting Requirements	9
Snap-On Mounting Method	9
Removing the Converter from the DIN Rail	10
<b>CONNECTIONS &amp; SETUP</b>	<b>11</b>
<b>Wiring &amp; Connections</b>	<b>11</b>
Connector Markings	12
Power Connections	13
Input Signal Connections	13
Digital Output Connections	14
Cascade Mode Multiple Unit I/O Connections	14
<b>Mode Selection Latching Pushbuttons</b>	<b>15</b>
Normal/Cascade Mode ON/OFF Button	15
Output H/L Inverter Mode	16
<b>LED INDICATORS</b>	<b>17</b>
<b>OPERATION</b>	<b>18</b>
Normal Mode	18
Inverted Mode	18
Cascade Mode	19
Inverted Cascade Mode	20
Multiple Unit Cascade Mode	21
<b>MOUNTING DIMENSIONS</b>	<b>22</b>
<b>TROUBLESHOOTING</b>	<b>23</b>

## Table of Figures

Figure 1. Connector Markings.....	12
Figure 2. Power Connections.....	13
Figure 3. High Voltage Input Channel Connections .....	13
Figure 4. Digital Output Connections .....	14
Figure 5. Cascade Mode Multiple Unit I/O Connections.....	14
Figure 6. Normal Mode ON/OFF (Cascade Mode) Switch .....	15
Figure 7. Inverted H/L Switch Set to Low .....	16
Figure 8. Dimensions - Front View.....	22
Figure 9. Dimensions - Side View .....	22
Table 1. Normal and Inverse Operation Logic .....	18
Table 2. Cascade Mode Operation Logic Example 1 .....	19
Table 3. Cascade Mode Operation Logic Example 2.....	19
Table 4. Inverted Cascade Mode Operation Logic Example 1 .....	20
Table 5. Inverted Cascade Mode Operation Logic Example 2 .....	20
Table 6. Multiple Unit Cascade Mode Operation Logic .....	21

## INTRODUCTION

The PDA1500 High VAC/VDC to Logic Level Converter is an easy to use DIN rail mounted device for converting high voltage signals into logic level signals for use as a digital input to a wide range of process control and display equipment.

The PDA1500 accepts up to four high voltage AC or DC signals. The PDA1500-115 inputs accept 85-130 VAC or VDC, and the PDA1500-230 inputs accept 185-265 VAC or VDC. Powered from 12-24 VDC, the PDA1500 can drive outputs even when no high voltage inputs are present. The outputs are user selectable for high or low states when voltage is present at the inputs.

Cascade mode is ideal for monitoring signals that can result in cascading or subsequent failures. This mode monitors the point of failure, when a failure in a single input causes a failure in all alarm points in a "series" system.

The PDA1500 is mounted in an ABS plastic DIN rail mounted enclosure for easy mounting inside a panel or instrument enclosure.

## ORDERING INFORMATION

Model	Description
PDA1500-115	85-130 VAC or VDC to Logic Level Converter
PDA1500-230	185-265 VAC or VDC to Logic Level Converter

## Recommended Associated Products

The PDA1500 High Voltage to Logic Level Converter is ideal for providing alarm and status indication to the following Precision Digital monitoring and control products.

Model	Description
PD154-6R2-1	Vigilante II 4-Point Alarm Annunciator Powered from 85-265 VAC
PD154-7R2-0	Vigilante II 4-Point Alarm Annunciator Powered from 12-36 VDC
PD158-6R2-1	Vigilante II 8-Point Alarm Annunciator Powered from 85-265 VAC
PD158-7R2-0	Vigilante II 8-Point Alarm Annunciator Powered from 12-36 VDC
PDA1044	ProVu 4 Digital Inputs and 4 Digital Outputs M-Link Expansion Module

## SPECIFICATIONS

*Except where noted all specifications apply to operation at +25°C.*

### General

**CONFIGURATION METHOD** Two latching pushbuttons for selection of output state inversion and cascade mode selection. No other programming required.

**INDICATORS** One green power LED. Four red LED indicators to monitor live inputs on channels 1-4. Two yellow LED indicators for inverted output and/or cascade output mode.

**INPUT CHANNELS** Four independent, isolated input channels CH1 to CH4

Model	Input Voltage
PDA1500-115	85-130 VAC or VDC
PDA1500-230	185-265 VAC or VDC

Inputs feature high common mode rejection, ideal for noisy environments.

**INPUT VOLTAGE THRESHOLD** Input high voltage levels are different for AC and DC voltages. Instantaneous value is used to determine threshold for AC input - RMS equivalents are shown below.

#### PDA1500-115

Input High Threshold Range:

60 VAC RMS (85 VAC peak) or 85 VDC,  $\pm 5\%$

Input Low Threshold Range:

31 VAC RMS (44 VAC peak) or 44 VDC,  $\pm 5\%$

#### PDA1500-230

Input High Threshold Range:

131 VAC RMS (185 VAC peak) or 185 VDC,  $\pm 5\%$

Input Low Threshold Range:

66 VAC RMS (94 VAC peak) or 94 VDC,  $\pm 5\%$

**INPUT CURRENT** 1.2 mA (typical) at "turn-on" or high input voltage

**PROPAGATION DELAYS** Input Propagation Delay to Logic Low: 4 $\mu$ s (typ); 15 $\mu$ s (max)  
Input Propagation Delay to Logic High: 8 $\mu$ s (typ); 40 $\mu$ s (max)

**INPUT IMPEDANCE** PDA1500-115: >60k $\Omega$  total impedance per channel  
PDA1500-230: >140k $\Omega$  total impedance per channel

**INPUT OVERLOAD** Must not exceed 50 mA DC (35 mA RMS) on input channels. Maximum input power dissipation is 230 mW. Surge protection included for up to 140 mA. Transient protection included for up to 500 mA.

<b>DIGITAL OUTPUTS</b>	Four TTL Logic (5V) independent digital outputs.
<b>OUTPUT LOGIC LEVELS</b>	Output Low: 0 to 0.33 V Output High: 4.4 to 5.0 V
<b>CASCADE MODE</b>	Typically used in Boiler applications to monitor for and detect fault conditions. See page 19 for details.
<b>POWER</b>	12-24 VDC $\pm$ 10%, 1.5 W max. Polarity sensitive. Short-circuit protected. Isolated.
<b>MAX POWER DISSIPATION</b>	PDA1500-115: 3W (total dissipation of unit) PDA1500-230: 4W (total dissipation of unit)
<b>ISOLATION</b>	630 VRMS between input channels; 3750 VRMS input-to-power line; 3750 VRMS input-to-output; 1000 VRMS output-to-power line
<b>OVERVOLTAGE</b>	Maximum overvoltage (transient) allowable is 6000 Vpeak for 60 seconds.
<b>ENVIRONMENTAL</b>	Operating temperature range: 0 to 65°C Storage temperature range: 0 to 65°C Relative humidity: 0 to 90% non-condensing
<b>CONNECTIONS</b>	Fixed screw terminal blocks accept 12 to 30 AWG solid or stranded wire
<b>ENCLOSURE</b>	Din rail mountable ABS plastic enclosure Color: black
<b>DIN RAIL SPECIFICATION</b>	35mm "top hat" DIN rail required
<b>TIGHTENING TORQUE</b>	Screw terminal connectors: 4.3 lb-in (0.56 Nm)
<b>OVERALL DIMENSIONS</b>	3.00" x 3.63" x 2.38" (76.3 mm x 92.3 mm x 60.5 mm) (W x H x D)
<b>WEIGHT</b>	12 oz (340.2 g)
<b>WARRANTY</b>	3 years parts & labor

## SAFETY INFORMATION



### CAUTION

*Read complete instructions prior to installation and operation of the meter.*



### WARNING

*Risk of electric shock or personal injury.*



### WARNING

*Hazardous voltages exist within enclosure and at wiring connections. Installation and service should be performed only by trained service personnel.*

## INSTALLATION

There is no need to open the converter housing to complete the installation, wiring, and setup of the meter.

### Unpacking

Remove the converter from the packing box. Inspect the packaging and contents for damage. Report damages, if any, to the carrier.

If any part is missing or the converter malfunctions, please contact your supplier or the factory for assistance.



## DIN Rail Mounting Instructions

### DIN Rail Mounting Requirements

- The converter requires a length of 35 mm “top hat” DIN rail 3.00" (76.3 mm) wide.
- The converter may be installed between other equipment on the same DIN rail without removing the other equipment.
- Clearance: allow at least 1.0" (25.4 mm) clearance above and below the PDA1500 on the installation back-panel for wiring.

### Snap-On Mounting Method

The converter may be snap-fit onto a DIN rail. The design of the mounting tab allows for tool-free mounting.



***Hazardous voltages exist within enclosure and at wiring connections. Installation and service should be performed only by trained service personnel.***

1. Hook the upper part of the converter onto the DIN rail at the desired location.

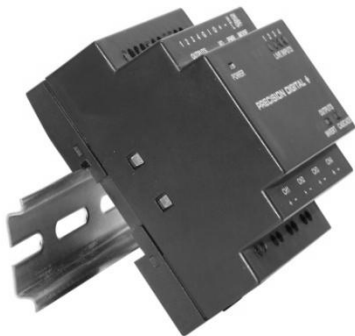

2. Press the converter flat onto the DIN rail. The mounting tab will snap into position, securing the converter.

## Removing the Converter from the DIN Rail

Removing the converter from the DIN rail requires the use of a small slotted screwdriver or similar tool.



***Hazardous voltages exist within enclosure and at wiring connections. Installation and service should be performed only by trained service personnel.***

1. Be sure no high voltage is present on the input channel wires by disconnecting power to those circuits.
2. Do not proceed while the converter is powered on.
3. Disconnect any wiring necessary to remove the converter.
4. Locate the DIN rail mounting tab on the lower side of the converter. It is located just behind the high voltage input lines.



5. Insert a small slotted screwdriver or similar tool into the mounting tab, and gently pull down on it.



6. While pulling down on the mounting tab, rotate the bottom of the converter enclosure up until the top of the converter is freed from the DIN rail

## CONNECTIONS & SETUP

### Wiring & Connections

All connections are made to fixed position screw terminal connectors located on the top and bottom of the enclosure.

**Caution**

Use copper wire with 60°C or 60/75°C insulation for all line voltage connections. Observe all safety regulations. Electrical wiring should be performed in accordance with all applicable national, state, and local codes to prevent damage to the converter and ensure personnel safety.

**WARNING**

***Hazardous voltages exist within enclosure and at wiring connections. Installation and service should be performed only by trained service personnel.***

## Connector Markings

Connector markings are printed on the front of the enclosure near each terminal. These markings indicate the function of the connection terminal next to the labeling.



Figure 1. Connector Markings

Group	Label	Description
OUTPUTS	1 (to 4)	Digital output 1 (to 4)
OUTPUTS	G	Digital output common
I/O	I	Multi-unit Cascade Mode input
I/O	O	Multi-unit Cascade Mode output
PWR	+	DC power positive terminal
PWR	-	DC power negative terminal
MODE	H/L	Location of Inverted Mode switch
MODE	ON/OFF	Location of Cascade Mode switch
CH1 (to CH4)	+	Channel 1 (to 4) high voltage input positive
CH1 (to CH4)	-	Channel 1 (to 4) 1 high voltage input negative

### Power Connections

Power connections are made to the two terminals labeled PWR on Figure 2. 12-24 VDC is applied with the polarity shown by the + and - symbols.

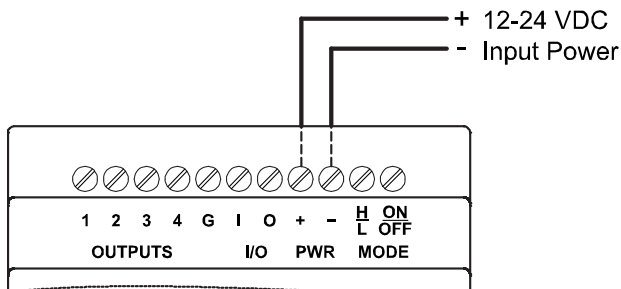

Figure 2. Power Connections

### Input Signal Connections

High voltage input channel 1-4 signal connections are made to the terminals labeled CH1, CH2, CH3, and CH4 on Figure 3.



***Hazardous voltages exist within enclosure and at wiring connections. Installation and service should be performed only by trained service personnel.***

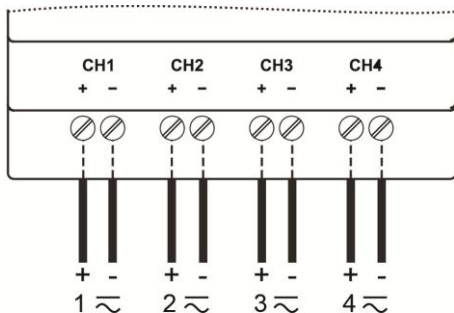

Figure 3. High Voltage Input Channel Connections

### Digital Output Connections

Low voltage digital outputs 1-4 signal connections are made to the terminals labeled OUTPUTS 1, 2, 3, 4, and G on Figure 4. The terminal labeled G is the common for all four digital outputs.

For input devices with a + and – terminal for every input channel, output terminal G will be connected to all negative digital input terminals.

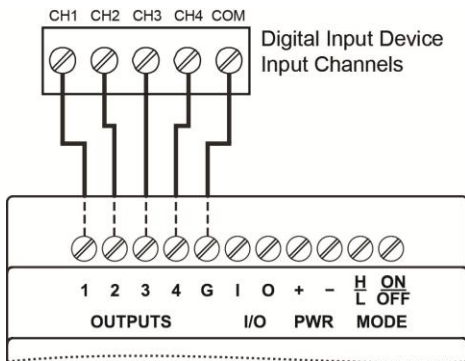

Figure 4. Digital Output Connections

### Cascade Mode Multiple Unit I/O Connections

When using Cascade Mode (see page 19), I/O terminals I and O shown in Figure 5 may be used to link together multiple converters, and provide additional inputs and outputs for monitoring. An unlimited number of units may be connected in this way.

To connect multiple units in Cascade Mode, connect terminal O on the first converter to the I terminal of the second. Continue to connect converters in this way until the last converter's O terminal is connected to the first converter's I terminal.

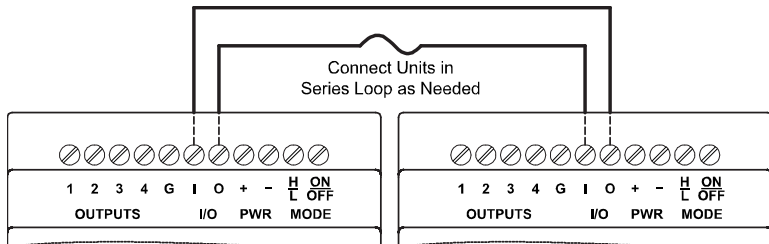

Figure 5. Cascade Mode Multiple Unit I/O Connections

## Mode Selection Latching Pushbuttons

There are two latching pushbuttons located on the top of the unit within the enclosure. These are located next to the ON/OFF and H/L labels, inside the terminal connection openings. These pushbuttons are used to enable Cascade Mode and/or Inverter Mode.

### Normal/Cascade Mode ON/OFF Button

To activate Cascade Mode (see page 19), press the latching pushbutton located in the terminal opening labeled MODE, ON/OFF.

Normal Mode operation is active when the button is in the forward position. Cascade Mode is active when the button is latched into the recessed position as shown below.

For information on Normal Mode operation, see page 18.

For information on Cascade Mode operation, see page 19.



**Figure 6. Normal Mode ON/OFF (Cascade Mode) Switch**

(Cascade Mode ON if recessed as shown.)

### Output H/L Inverter Mode

The H/L latching pushbutton is used to invert the output states. For example, in Normal Mode, when input channels CH1-CH4 detect high voltage, the corresponding output will provide an active high. When high voltage is not detected on an input, the corresponding output will provide an active low signal.

This default output state may be inverted with the Output H/L button. When the H/L button is latched into the recessed position as shown below, the output condition will be inverted. When input channels CH1-CH4 detect high voltage, the corresponding output will provide an active low. When high voltage is not detected on an input, the corresponding output will provide an active high signal.

Inverter Mode may be applied to Cascade outputs as well.

For information on Inverted Normal Mode operation, see page 18.

For information on Inverted Cascade Mode operation, see page 20.

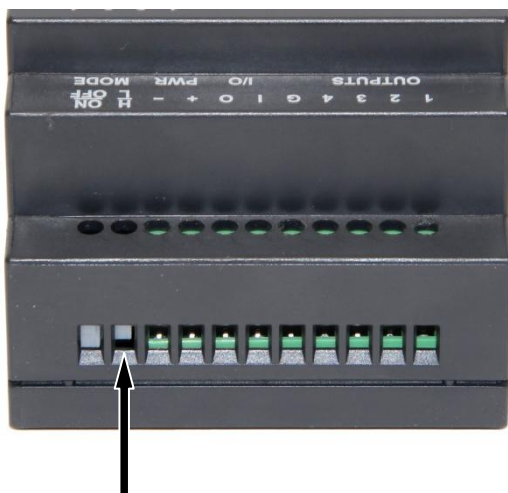
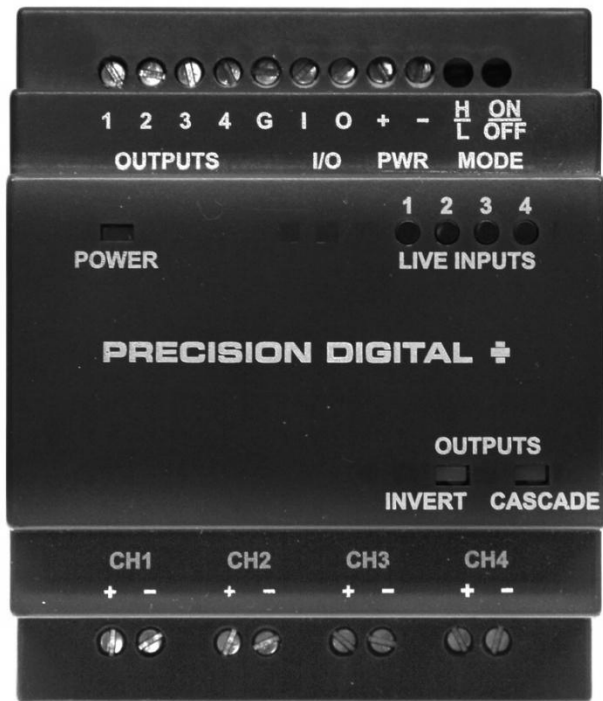

**Figure 7. Inverted H/L Switch Set to Low**

**(Active low output when input voltage present if recessed as shown.)**



## LED INDICATORS



LED Indicator	Color	Description
POWER	Green	LED ON indicates unit is powered
LIVE INPUTS (1 - 4)	Red	LED ON indicates high voltage is present on corresponding input channel (CH1 – CH4)
INVERT	Yellow	LED ON if Inverted Mode is enabled (low output when input high)
CASCADE	Yellow	LED ON if Cascade Mode is enabled

## OPERATION

The PDA1500 High Voltage AC/DC to Logic Level Converter accepts up to four high voltage input signals and outputs a TTL logic (5 V) signal representative of each input's status (whether high voltage is present or not).

### Normal Mode

In Normal Mode operation, the converter detects the presence of high voltage on input channels CH1 to CH4. If high voltage is present, the corresponding output 1 to 4 will be high. If voltage is below the detection range, the corresponding output will be low.

### Inverted Mode

In Inverted Mode operation, the state of all outputs is the inverse of what they would be in Normal Mode. The converter detects the presence of high voltage on input channels CH1 to CH4. If high voltage is present on an input channel, the corresponding output 1 to 4 will be low. If voltage is below the detection range on an input channel, the corresponding output will be high.

**Table 1. Normal and Inverse Operation Logic**

Input Voltage <sup>1</sup> (CH1-CH4)	LIVE INPUTS LEDs	MODE Switch Positions		OUTPUTS State <sup>2</sup> (1-4)
		H/L	ON/OFF	
<b>Normal Mode</b>				
High	On (Red)	Off	Off	High
Low	Off	Off	Off	Low
<b>Inverted Mode</b>				
High	On (Red)	Recessed (On)	Off	Low
Low	Off	Recessed (On)	Off	High

1. Input "High" for the PDA1500-115 is 85-130 VAC or VDC.  
Input "High" for the PDA1500-230 is 185-265 VAC or VDC.  
Input "Low" is any voltage lower than the "High" range.
2. Output "High" is 4.4 to 5.0 VDC.  
Output "Low" is 0 to 0.33 VDC

## Cascade Mode

Cascade Mode is a special operation mode used for the monitoring of high voltage interlocks where one failure causes a failure of all monitoring points further down in the system. Examples of this include the many interlocks on boiler systems, where a single failure can cause a cascade of failures later in the system. Cascade Mode will indicate the single point of failure in these series systems.

Cascade mode provides a digital output alarm state if the corresponding input channel is active, but the next subsequent input channel is inactive. This can be used to identify the single point of system failure, without indicating every alarm state throughout the linked series interlock system.

Cascade mode utilizes exclusive NOR (inverting OR) logic.

**Table 2. Cascade Mode Operation Logic Example 1**

Input Channel	Input Voltage <sup>1</sup> (CH1-CH4)	LIVE INPUTS LED	OUTPUTS State <sup>2</sup> (1-4)	XNOR Logic
CH1	High	On (Red)	High	CH1 & CH2
CH2	High	On (Red)	Low	CH2 & CH3
CH3	Low	Off	High	CH3 & CH4
CH4	Low	Off	High	N/A

**Table 3. Cascade Mode Operation Logic Example 2**

Input Channel	Input Voltage <sup>1</sup> (CH1-CH4)	LIVE INPUTS LED	OUTPUTS State <sup>2</sup> (1-4)	XNOR Logic
CH1	High	On (Red)	Low	CH1 & CH2
CH2	Low	Off	High	CH2 & CH3
CH3	Low	Off	High	CH3 & CH4
CH4	Low	Off	High	N/A

1. Input "High" for the PDA1500-115 is 85-130 VAC or VDC. Input "High" for the PDA1500-230 is 185-265 VAC or VDC. Input "Low" is any voltage lower than the "High" range.
2. Output "High" is 4.4 to 5.0 VDC ← *fixed extra space here*. Output "Low" is 0 to 0.33 VDC

## Inverted Cascade Mode

Inverted Mode may be applied to Cascade Mode. When the H/L pushbutton is latched in the recessed position, Inverted Mode is active. The outputs behave using the same logic as in Cascade Mode, but the output states are all inverted.

This makes the Cascade Mode output function using exclusive OR (XOR) logic.

**Table 4. Inverted Cascade Mode Operation Logic Example 1**

<b>Input Channel</b>	<b>Input Voltage<sup>1</sup> (CH1-CH4)</b>	<b>LIVE INPUTS LED</b>	<b>OUTPUTS State<sup>2</sup> (1-4)</b>	<b>XOR Logic</b>
CH1	High	On (Red)	Low	CH1 & CH2
CH2	High	On (Red)	High	CH2 & CH3
CH3	Low	Off	Low	CH3 & CH4
CH4	Low	Off	Low	N/A

**Table 5. Inverted Cascade Mode Operation Logic Example 2**

<b>Input Channel</b>	<b>Input Voltage<sup>1</sup> (CH1-CH4)</b>	<b>LIVE INPUTS LED</b>	<b>OUTPUTS State<sup>2</sup> (1-4)</b>	<b>XOR Logic</b>
CH1	High	On (Red)	High	CH1 & CH2
CH2	Low	Off	Low	CH2 & CH3
CH3	Low	Off	Low	CH3 & CH4
CH4	Low	Off	Low	N/A

1. Input "High" for the PDA1500-115 is 85-130 VAC or VDC.  
Input "High" for the PDA1500-230 is 185-265 VAC or VDC.  
Input "Low" is any voltage lower than the "High" range.
2. Output "High" is 4.4 to 5.0 VDC.  
Output "Low" is 0 to 0.33 VDC

## Multiple Unit Cascade Mode

Cascade Mode logic may be combined across multiple Logic Level Converters to monitor more than 3 alarm outputs (or 4 inputs). When wired together, output four (4) of a Logic Level Converter will monitor input CH4 and CH1 of the next Logic Level Converter wired in series with it.

For information on how to connect units for Cascade Mode, see Cascade Mode Multiple Unit I/O Connections on page 14.

Inverted Cascade Mode will also work across multiple units.

Multiple unit Cascade Mode may be used across an unlimited number of units.

**Table 6. Multiple Unit Cascade Mode Operation Logic**

Unit #	Input Channel	Input Voltage <sup>1</sup> (CH1-CH4)	LIVE INPUTS LED	OUTPUTS State <sup>2</sup> (1-4)	XNOR Logic (Unit #)
1	CH1	High	On (Red)	Low	CH1 (1) & CH2 (1)
1	CH2	High	On (Red)	Low	CH2 (1) & CH3 (1)
1	CH3	High	On (Red)	Low	CH3 (1) & CH4 (1)
1	CH4	High	On (Red)	High	CH4 (1) & CH1 (2)
2	CH1	Low	Off	Low	CH1 (2) & CH2 (2)
2	CH2	Low	Off	Low	CH2 (2) & CH3 (2)
2	CH3	Low	Off	Low	CH3 (2) & CH4 (2)
2	CH4	Low	Off	Low	CH4 (2) & CH1 (1)

1. Input "High" for the PDA1500-115 is 85-130 VAC or VDC.  
Input "High" for the PDA1500-230 is 185-265 VAC or VDC.  
Input "Low" is any voltage lower than the "High" range.
2. Output "High" is 4.4 to 5.0 VDC.  
Output "Low" is 0 to 0.33 VDC

## MOUNTING DIMENSIONS

Units: in [mm]

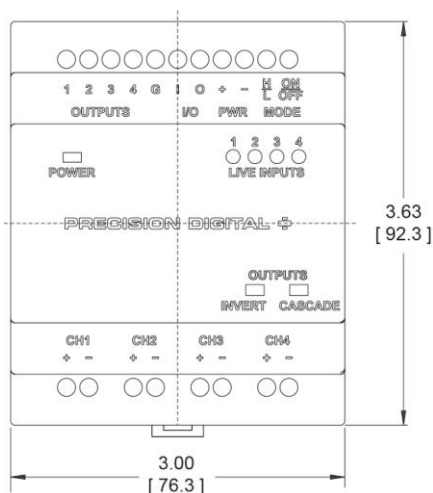

Figure 8. Dimensions - Front View

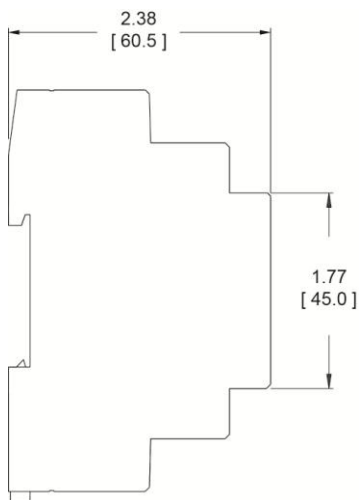

Figure 9. Dimensions - Side View

## TROUBLESHOOTING

The rugged design and simple configuration of the Logic Level Converter should make it unusual for the installer or operator to refer to this section of the manual. However, should a problem be encountered, the following tips may prove useful.

Symptom	Check/Action
No LEDs are ON or outputs present	Check power at power connector
Digital outputs behave in an unexpected manner	Check the status of the Inverted Mode (H/L) button and Cascade Mode (ON/OFF) button
When high voltage is present on an input, no LIVE INPUT LED or output condition changes	Check the model number and verify the input voltage range
Other symptoms not described above	Call Technical Support for assistance.

## How to Contact Precision Digital

- For Technical Support please  
Call: (800) 610-5239 or (508) 655-7300  
Fax: (508) 655-8990  
Email: [support@predig.com](mailto:support@predig.com)
- For Sales Support or to place an order please contact your local distributor or  
Call: (800) 343-1001 or (508) 655-7300  
Fax: (508) 655-8990  
Email: [sales@predig.com](mailto:sales@predig.com)
- For the latest version of this manual please visit **[www.predig.com](http://www.predig.com)**