

# PD2-6210/PD2-6310

Helios Dual-Line 6-Digit Batch Controllers



PD2-6210

**HELIOS**

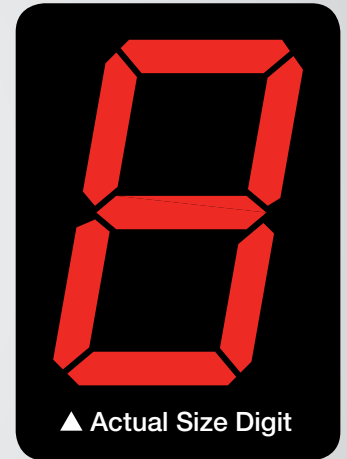

**BATCH CONTROL**

#### COMMON HELIOS METER FEATURES

- Large 1.80" Digits
- Dual-Line 6-Digit Display
- Readable from up to 100 Feet (30 Meters) Away
- Superluminous Sunlight Readable Display
- NEMA 4X, IP65 Rated Field Mountable Enclosure
- Operating Temperature Range of -40 to 65°C (-40 to 150°F)
- Universal 85-265 VAC, or 12/24 VDC Input Power Models
- Isolated 24 VDC Transmitter Power Supply
- On-Board Digital Input
- 2 or 4 Relays + Isolated 4-20 mA Output Options
- Onboard USB & RS-485 Serial Communications
- Modbus® RTU Communication Protocol Standard
- Program the Meter from a PC with Onboard USB and MeterView® Pro

#### BATCH CONTROLLER FEATURES

- Single or Multi-Stage Batch Control (up to 4 Relays)
- Display Batch Total, Rate, Grand Total, Count or Preset
- Automatic Overrun Correction
- Rate in Units per Second, Minute, Hour, or Day
- Automatic or Manual Batch Control
- Low or High Flow Alarms while Batching
- 9 Digit Grand Total with Overflow Feature
- Count Up or Down with Each Batch

#### ANALOG INPUTS

- 0-20 mA, 4-20 mA, 0-5 V, 1-5 V, and ±10 V Inputs

#### PULSE INPUTS

- Pulse, Open Collector, NPN, PNP, TTL, Switch Contact, Sine Wave (Coil), Square Wave Inputs

# PD2-6210 / PD2-6310 Helios Batch Controllers

NEMA 4X, IP65  
Rated Enclosure



UV Resistant  
Sunlight Readable Display



▲ PD2-6210 Shown



## INTUITIVE BATCH CONTROL

The Helios PD2-6210 and PD2-6310 are multi-purpose, easy to use, large-display batch controllers ideal for simplifying independent batch control operations where local control is preferred to expensive and expansive plant operation systems. They feature large 1.8 superluminous inch LED digits, which can be read in sunlight from up to 100 feet away. It is housed in a water-resistant, field mountable NEMA 4X and IP65 rated enclosure for convenient indoor and outdoor installation. The controllers come programmed for easy start, pause, stop, and batch size (preset) changes. Display line two (2) can be programmed to display rate, grand total, batch count, or preset by cycling the Stop (F3) button.

## Clearly Labeled Displays

The upper display alternates the display to show the controller state when in pause or stop mode. When displaying rate, grand total, batch count, or preset, the lower display alternates between the display value and the function or unit of measure.

## Easy to Program

The user friendly dual-line display makes the Helios easy to set up & program with its programming buttons located behind the front door panel. There are three levels of password protection to help maintain the integrity of the programming and there are no jumpers to set for the meter input selection.



Input Setup



Display Setup

## Easily Choose Your Display Information



### Batch Total & Preset

The preset on the lower display provides even quicker access to the preset menu just by using the arrow keys to change the value.



### Batch Total & Rate

The rate on the lower display may be alternated with units for variable flow batching systems. Rate alarms may also be used during the batch process.



### Batch Total & Batch Count

The batch count on the lower display, tracks completed batches. The count may be set back to 0 with the reset menu.



### Batch Total & Grand Total

A grand total with overflow digits for up to a 9 digit total may be displayed in the lower display, with password protection and non-resettable programmable features.

## Superluminous Sunlight Readable Display

The Helios' standard SunBright display features extraordinarily bright LEDs. It is perfect for applications where the meter is in direct sunlight or in applications where visibility may be impaired by smoke, fog, dust, or distance.

## Grand Total Displays Up to 9 Digits

These batch controllers can display up to nine digits of total flow with the grand total feature. In the diagrams below, the batch controller is displaying 532,831,470 on the bottom line by toggling between a display of “oF 532” and “831470”. Notice the GT and arrow ▲ symbol LEDs are lit up indicating the display is in a grand total overflow mode.



## BATCH CONTROLLER CAPABILITIES

A Helios batch controller can be programmed for a wide variety of applications. Setup is easy for single or multi-stage batching. Automatic overrun correction keeps the batch size accurate, even over time and with system wear. It can record grand total, or non-resettable grand total with a time base of seconds, minutes, hours or days. The user can program a conversion factor, and configure a non-resettable grand total, and password protection.

### Single and Multi-Stage Batching

The Helios can be used as a single or multi-stage batch controller. Relays assigned to the total act as batch control relays, with additional relays beyond the first including a preclose value. The preclose deactivates the relay before the batch is finished, to allow slower fill rates and a more accurate batch finish. With expansion module relays, up to eight-stage batching is possible. Each additional stage batching relay has an individually programmable preclose amount.

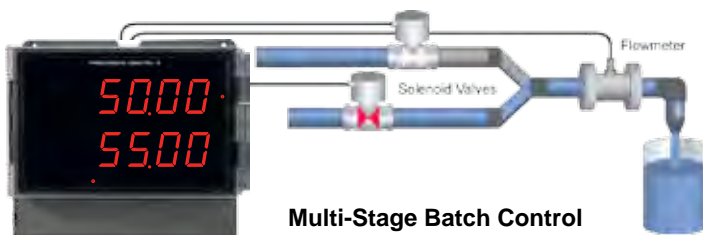
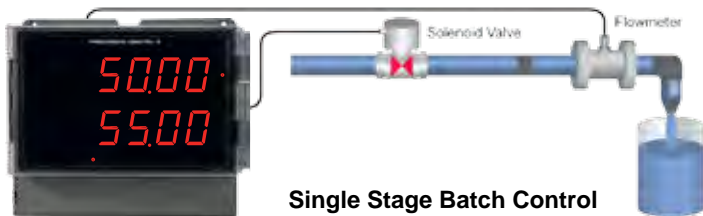

### Manual or Automatic Batch Control

Batches may be started manually with the START with a remote digital input trigger. Batches may also be programmed to start automatically after a 0 to 999.9 second delay after the end of the last completed batch. A manually stopped batch will not automatically restart. A digital input button must be used to re-start the process.

### Automatic Overrun Correction

The Helios batch controller will correct for batch overrun or shortages automatically. By tracking the amount the batch was off by, the controller will automatically adjust the batch by modifying the batch relay deactivation time.

### Non-Resettable Grand Total

The user can set up the grand total to be non-resettable by entering a specific password. Once this is done, the grand total can never be reset.

### Total Conversion Factor

The user can enter a conversion factor that allows the controller to display total in different units than the rate. For instance, an operator could measure flow rate in gallons per minute and grand total in hundredths of acre-feet.

### Grand Total & Rate Alarms

The Helios’s four internal and four external relays can be set up to alarm when the grand total reaches a user-defined set point or when the rate is above or below a certain value. Rate alarms are only activated when the batching process is running. A variety of reset modes are available and the user can also program time delays and fail-safe operation.

### On-Board Digital Input

The PD2-6210 and PD2-6310 include a digital input as standard. This digital input can operate with the tare, reset tare, or interlock relays feature, force relays on from a signal from a PLC or relay on other equipment, and much more. This is ideal for installations where the meter is inaccessible behind a cover, or where an additional function key is needed for customized operation.

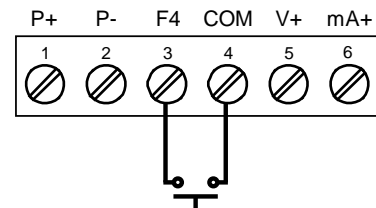

### Rounding

The rounding feature is used to give the user a steadier display with fluctuating signals. It causes the display to round to the nearest value according to the rounding value selected (1, 2, 5, 10, 20, 50, or 100). For example, with a rounding value of 10, and a input of 12346, the display would indicate 12350.

### Three Tier Password Protection

The PD2-6210 and PD2-6310 offers 3 levels of password protection:

- Level 1 protection allows the operator use of only the 3 pre-configured function keys without a password.
- Level 2 protection allows the operator use of only the function keys and the ability to change set points without a password
- Level 3 protection restricts the operator from using the function keys and all meter configuration menus without a password.

# PD2-6210 / PD2-6310 Helios Batch Controllers

## METERVIEW® PRO SOFTWARE

### Free USB Programming Software

The Helios comes with free **MeterView® Pro** programming software that connects to your PC with a standard USB cable that is provided with each instrument. The software will allow you to configure, monitor, control, and datalog a Helios PD2-6210 or PD2-6310 using your PC. A new and very useful feature of this software is that it is resident on the Helios meter and installed directly into your PC. This eliminates the need to install drivers or download software from the internet. Just connect the Helios to your PC (the Helios even gets its power from the PC so you don't have to provide external power!) and within minutes you will be programming it with the free software.



### Batch Control From a Computer

Through MeterView Pro Software, the preset and relay 2 preclose may be easily changed from the main control window. The total and grand total may be reset with just the click of a button. The batch controller may be started, paused, and stopped through the control window, for full featured batch controller operation.

### Fully Program the Controller

All the programming parameters of the controller may be configured from MeterView Pro Software. The configuration file may be saved for later use, and saved configuration files may be loaded into the software for download into the Helios.

## OUTPUTS

### Relay Outputs

The Helios has up to four 3 A Form C relays (SPDT) with multiple programmable functions. One (relay 1) should always be used for batch control. Other relays may be configured as additional batch relays, with or without preclose for multi-stage batching or as alarms for the rate or grand total. Each alarm has multiple power loss fail-safe options. Alarm relays can be configured for proper protective action upon input loop break. Alarm relay ON and OFF delay times are user adjustable. Up to four front panel indicators show alarm and/or relay state. All alarm relays can be configured for 0-100% deadband. Rate alarms are only active while a batch is running.

### Relay Operation/Configuration

There are powerful relay functions that can be configured in the Helios controller, including:

- Single and multiple stage batch control with preclose
- Manual and automatic batch control modes
- Rate alarms during batch process
- Grand total alarms
- Sampling function

- User selectable fail-safe operation
- Relay action for loss (break) of 4-20 mA input signal (PD2-6210)
- Time delay (on and off), independent for each alarm relay

### Analog Output

The isolated analog retransmission signal can be configured to represent the batch total, grand total, maximum (peak) value, minimum (valley) value, the value for any of the four relay set points, manual setting control, or Modbus input. While the output is nominally 4-20 mA, the signal will accurately accommodate under- and over-ranges from 1 to 23 mA.

### Isolated Transmitter Power Supplies

A powerful 24 V @ 200 mA power supply is a standard feature on the Helios controller. It can be configured for 5, 10, or 24 V (default) by means of a simple internal jumper (see manual). An additional power supply (24 V @ 40 mA) is standard with the 4-20 mA output option.

## DIGITAL COMMUNICATIONS

### Modbus® RTU Serial Communications

With onboard RS485 serial communication, the Helios PD2-6210 and PD2-6310 can communicate with any Modbus *master* device using the popular Modbus communications protocol that is included in every Helios. This greatly increases the flexibility of the meter. Modbus provides much more capability than read PV and write set points. Below are some examples of other things that can be done with the meter's Modbus communications.

- Start, pause, stop, or change preset values
- Send a 6-character message to the lower display upon an event
- Remote user control (i.e. change set points, acknowledge alarms)
- Read rate, total, grand total, batch count, etc.

## MOUNTING OPTIONS

### Pipe Mounting Kit

The meter can also be mounted to a pipe using the optional pipe mounting kit (PDA6260). This kit includes two mounting plates, two U-bolts, and the necessary nuts and bolts. See *PD2-6210/PD2-6310 manual for instructions*.

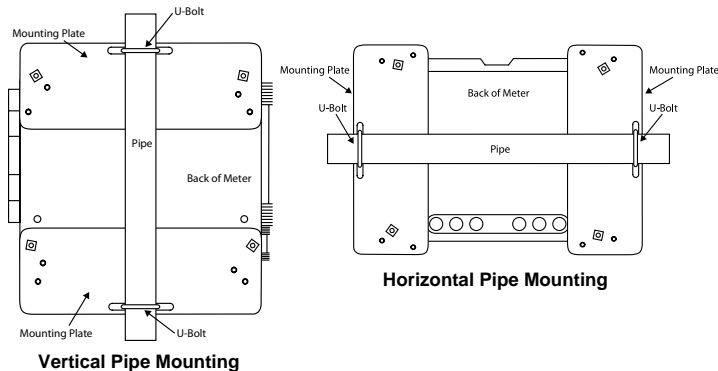

### Wall Mounting

The Helios meter can be mounted to any wall using the four provided mounting holes. Note that the bottom mounting holes are located behind the front door panel. See *PD2-6210/PD2-6310 manual for instructions*.

## MANUAL MULTI-STAGE BATCH CONTROL OPERATION

### System Setup

Both valves are closed with an empty barrel in place. The batched total is displayed in the upper display, the preset is selected for the lower display.

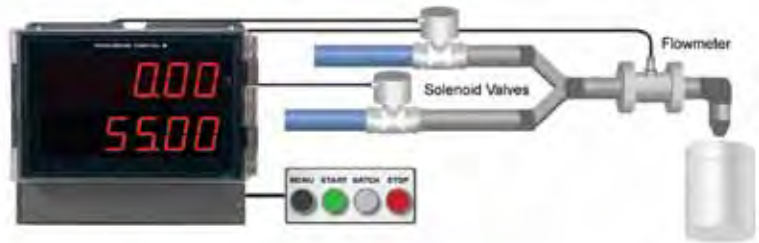

### Batch Start

The START button is pressed. Both valves open. The barrel begins to fill.

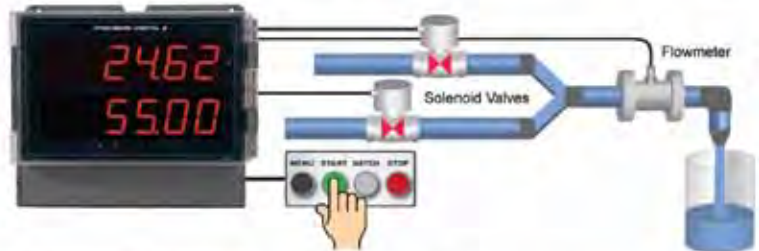

### Preclose Valve

When the batch total reaches a value of 50.00 (Preset [55.00] – Preclose [5.00]) the full-flow valve closes. The fill rate of the tank slows as a result.

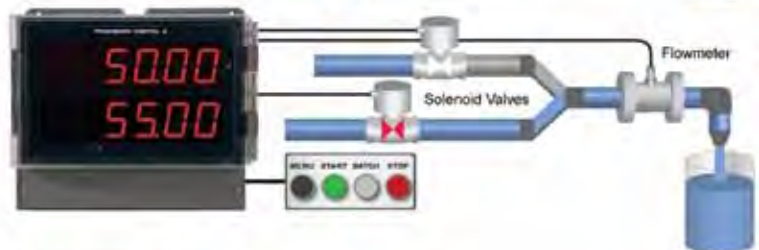

### Completed Batch

When the batch total equals the preset amount, the restricted-flow valve closes. The barrel is now full. If some overrun occurs, the next batch will adjust for this offset amount to maintain accuracy.

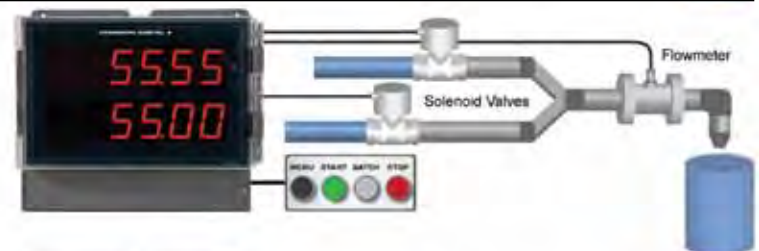

### Change Preset

After placing a new, empty barrel, a new preset fill amount may be selected with the Batch key, while the process is stopped.

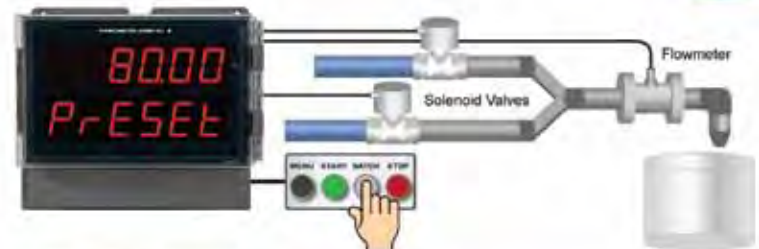

### Begin New Batch

Press the START key and a new batch will begin. With both valves open, the process continues.

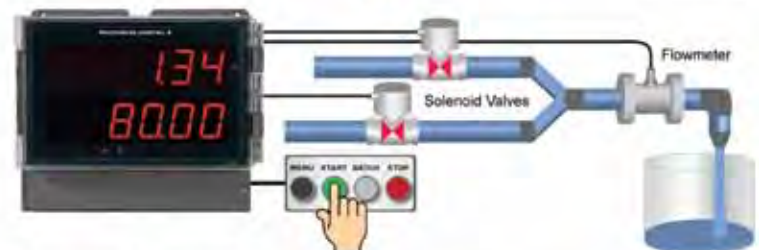

### Pause/Stop

At any time, the STOP button may be pressed, once to Pause the process, or twice to cancel the batch, which stops the process.

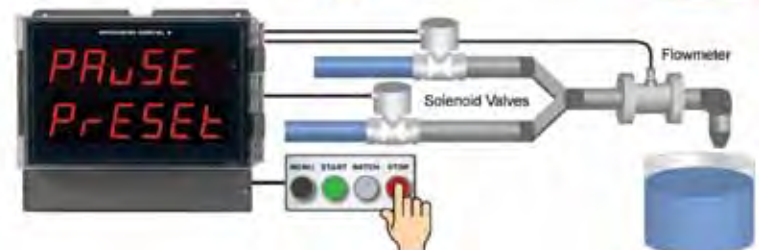

# PD2-6210 / PD2-6310 Helios Batch Controllers

## SPECIFICATIONS

Except where noted all specifications apply to operation at +25°C.

### General

**Display:** Two lines with 1.8" (46 mm) high digits, red LEDs; 6 digits per line (-99999 to 999999), with lead zero blanking

**Display Intensity:** Eight user selectable intensity levels

**Display Update Rate:** 5/second (200 ms)

**Overrange:** Display flashes 999999

**Underrange:** Display flashes -999999

**Display Assignment:** Display lines 1 & 2 may be assigned to rate, total, grand total, batch count, preset, set points, units (lower display only), alternating R & T, R & GT, preset & rate, max & min, or a Modbus display register. Any rate/total/grand total display may be programmed to alternate with a custom unit or tag.

**Alternating Display:** Displays alternate every 10 seconds when display is selected or batch is paused.

**Programming Methods:** Four programming buttons, digital inputs, PC and MeterView Pro software, or Modbus registers.

**Noise Filter:** Programmable from 2 to 199 (0 will disable filter)

**Filter Bypass:** Programmable from 0.1 to 99.9% of calibrated span.

**Recalibration:** All ranges are calibrated at the factory. Recalibration is recommended at least every 12 months.

**Max/Min Display:** Max/min readings reached by the process are stored until reset by the user or until power to the controller is turned off.

**Password:** Three programmable passwords restrict modification of programmed settings.

Pass 1: Allows use of function keys and digital inputs

Pass 2: Allows use of function keys, digital inputs and editing set/reset points

Pass 3: Restricts all programming, function keys, and digital inputs

Total: Prevents resetting the total manually

Gtotal: Prevents resetting the grand total manually.

**Power Options:** 85-265 VAC 50/60 Hz, 90-265 VDC, 20 W max or 12-24 VDC  $\pm$  10%, 15 W max. Powered over USB for configuration only.

**Non-Volatile Memory:** All programmed settings are stored in non-volatile memory for a minimum of ten years if power is lost.

**Fuse:** Required external fuse: UL Recognized, 5 A max, slow blow; up to 6 controllers may share one 5 A fuse.

**Isolated Transmitter Power Supply:** Terminals P+ & P-: 24 VDC  $\pm$  10%. 12-24 VDC powered models selectable for 24, 10, or 5 VDC supply (internal P+/P- switch). 85-265 VAC models rated @ 200 mA max, 12-24 VDC powered models rated @ 100 mA max, @ 50 mA max for 5 or 10 VDC supply.

**Normal Rejection Mode:** Greater than 60 dB at 50/60 Hz (PD2-6210)

**Isolation:** 4 kV input/output-to-power line. 500 V input-to-output or output-to-P+ supply.

**Overvoltage Category:** Installation Overvoltage Category II: Local level with smaller transient overvoltages than Installation Overvoltage Category III.

**Environmental:** Operating temperature range: -40 to 150°F (-40 to 65°C)

Storage temperature range: -40 to 185°F (-40 to 85°C)

Relative humidity: 0 to 90% non-condensing

**Connections:** Removable and integrated screw terminal blocks accept 12 to 22 AWG wire.

**Enclosure:** UL Type 4X, IP65 rated. Polycarbonate & glass blended plastic case, color: gray. Includes four PG11 through-hole conduit openings, with two factory installed PG11, IP68, black nylon threaded hole plugs with backing nuts.

**Wall Mounting:** Four (4) mounting holes provided for screwing controller into wall. See instruction manual for details.

**Pipe Mounting:** Optional pipe mounting kit (PDA6260) allows for pipe mounting. Sold separately. See instruction manual for details.

**Tightening Torque:** Removable Screw Terminals: 5 lb-in (0.56 Nm)

Digital I/O and RS485 Terminals: 2.2 lb-in (0.25 Nm)

**Overall Dimensions:** 10.63" x 12.59" x 4.77"

(270 mm x 319.7 mm x 121.2 mm) (W x H x D)

**Weight:** 6.10 lbs (2.76 kg)

**UL File Number:** UL & C-UL Listed. E160849; 508 Industrial Control Equipment.

**Warranty:** 3 years parts & labor

**USB Connection:** Compatibility: USB 2.0 Standard, Compliant  
Connector Type: Micro-B receptacle

Cable: USB A Male to Micro-B Cable

Driver: Windows 98/SE, ME, 2000, Server 2003/2008, XP 32/64-Bit, Vista 32/64-Bit, Windows 7 32/64-Bit, Windows 10 32/64-Bit

Power: USB Port

### PD2-6210 Analog Input

**Inputs:** Field selectable: 0-20, 4-20 mA,  $\pm$ 10 VDC (0-5, 1-5, 0-10 V), Modbus PV (Slave)

**Accuracy:**  $\pm$ 0.03% of calibrated span  $\pm$ 1 count, square root & programmable exponent accuracy range: 10-100% of calibrated span

**Temperature Drift:** 0.005% of calibrated span/ $^{\circ}$ C max from 0 to 65 $^{\circ}$ C ambient, 0.01% of calibrated span/ $^{\circ}$ C max from -40 to 0 $^{\circ}$ C ambient

**Signal Input Conditioning:** Linear, square root, programmable exponent, or round horizontal tank volume calculation.

**Multi-Point Linearization:** 2 to 32 points

**Programmable Exponent:** 1.0001 to 2.9999

**Round H Tank:** Diameter & Length: 999.999 inch or cm calculates volume in gallons or liters respectively.

**Low-Flow Cutoff:** 0-999999 (0 disables cutoff function)

**Decimal Point:** Up to five decimal places or none: d.dddd, d.dddd, d.dddd, d.dd, dd, or d.dddd

**Calibration Range:**

Input Range	Minimum Span Input 1 & 2
4-20 mA	0.15 mA
$\pm$ 10 V	0.10 V

An error message will appear if input 1 and input 2 signals are too close together.

**Input Impedance:** Voltage ranges: greater than 500 k $\Omega$

Current ranges: 50 - 100  $\Omega$  (depending on resettable fuse impedance)

**Input Overload:** Current input protected by resettable fuse, 30 VDC max. Fuse resets automatically after fault is removed.

**F4 Digital Input Contacts:** 3.3 VDC on contact. Connect normally open contacts across F4 to COM.

**F4 Digital Input Logic Levels:** Logic High: 3 to 5 VDC;  
Logic Low: 0 to 1.25 VDC

### PD2-6310 Pulse Input

**Inputs:** Field selectable: Pulse or square wave 0-5 V, 0-12 V, or 0 24 V @ 30 kHz; TTL; open collector 4.7 k $\Omega$  pull-up to 5 V @ 30 kHz; NPN or PNP transistor, switch contact 4.7 k $\Omega$  pull-up to 5 V @ 40 Hz; Modbus PV (Slave)

**Low Voltage Mag Pickup (Isolated):** Sensitivity: 40 mVp-p to 8 Vp-p

**Minimum Input Frequency:** 0.001 Hz - Minimum frequency is dependent on high gate setting.

**Maximum Input Frequency:** 30,000 Hz (10,000 for Low Voltage Mag Pickup)

**Input Impedance:** Pulse input: Greater than 300 k $\Omega$  @ 1 kHz. Open collector/switch input: 4.7 k $\Omega$  pull-up to 5 V.

**Accuracy:**  $\pm$ 0.03% of calibrated span  $\pm$ 1 count

**Temperature Drift:** Rate display is not affected by changes in temperature.

**Multi-Point Linearization:** 2 to 32 points

**Low-Flow Cutoff:** 0-999999 (0 disables cutoff function)

**Decimal Point:** Up to five decimal places or none: d.dddd, d.dddd, d.dddd, d.dd, dd, or d.dddd

**Calibration:** May be calibrated using K-factor, internal calibration, or by applying an external calibration signal.

**K-Factor:** Field programmable K-factor converts input pulses to rate in engineering units. May be programmed from 0.00001 to 999,999 pulses/unit.

**Calibration Range:** Input 1 signal may be set anywhere in the range of the controller; input 2 signal may be set anywhere above or below input 1 setting. Minimum input span between any two inputs is 10 Hz. An error message will appear if the input 1 and input 2 signals are too close together.

**Filter:** Programmable contact de-bounce filter, 40 to 999 Hz maximum input frequency allowed with low speed filter.

**Time Base:** Second, minute, hour, or day

# PD2-6210 / PD2-6310 Helios Batch Controllers

**Gate:** *Low Gate:* 0.1-99.9 seconds; *High Gate:* 2.0-999.9 seconds

**F4 Digital Input Contacts:** 3.3 VDC on contact. Connect normally open contacts across F4 to COM.

**F4 Digital Input Logic Levels:** *Logic High:* 3 to 5 VDC;  
*Logic Low:* 0 to 1.25 VDC

## Batch Controller

**Rate Display Indication:** 0 to 999999, lead zero blanking. "R" LED illuminates while displaying rate.

**Batch Total & Grand Total Display:** 0 to 999,999; automatic lead zero blanking. "T" LED is illuminated while displaying batch total. "GT" LEDs are illuminated while displaying grand total. Up to 999,999 for batch total/preset. Up to 999,999,999 with grand total-overflow feature. "oF" is displayed to the left of grand total overflow and ▲ LED is illuminated.

**Batch Total Decimal Point:** Up to five decimal places or none: d.dddd, d.dddd, d.ddd, d.dd, dd, or dddddd

*Total decimal point is independent of rate decimal point.*

**Totalizer:** Calculates total based on rate and field programmable multiplier to display total in engineering units. Time base must be selected according to the time units in which the rate is displayed.

**Batch Preset:** 0.00001 to 999,999 based on batch total decimal point.

**Automatic Batch Restart Delay:** 00000.1 to 999.9 seconds. The batch will automatically restart after completion of the last batch.

**Grand Total Rollover:** Totalizer rolls over when display exceeds 999,999,999. Relay status reflects the display value.

**Grand Total Alarms:** Up to seven, user selectable under Setup menu. Any set point can be assigned to grand total and may be programmed anywhere in the range of the controller for grand total alarm indication. Relay 1 should always be assigned to batch.

**Grand Total Reset:** External contact closure on digital inputs, automatically via user selectable preset value and time delay, or through serial communications.

**Grand Total Reset Password:** Grand total passwords may be entered to prevent resetting the grand total from the buttons behind the front panel.

**Non-Resettable Grand Total:** The grand total can be programmed as a non-resettable total by entering the password "050873".

**CAUTION!** Once the Grand Total has been programmed as "non-resettable" the feature **CANNOT** be disabled.

## Relays

**Rating:** 2 or 4 SPDT (Form C) internal and/or 4 SPST (Form A) external; rated 3 A @ 30 VDC and 125/250 VAC resistive load; 1/14 HP (≈ 50 W) @ 125/250 VAC for inductive loads

**Noise Suppression:** Noise suppression is recommended for each relay contact switching inductive loads.

**Relay Assignment:** Relays may be assigned to batch control, sampling, rate, or grand total alarms.

**Preclose:** 0-100% of batch size, individually user programmable for each additional batch control relay beyond the first.

**Alarm Deadband:** 0-100% of span, user programmable

**High or Low Alarm:** User may program any alarm for high or low trip point. Unused alarm LEDs and relays may be disabled (turned off).

**Batching Relay Operation:** Single or (2 to 8) multi-relay batching with optional preclose for multi-stage operation. Each additional relay may be programmed with an individual preclose value.

**Relay Operation: Primary Functions:**

Batch Control, Automatic (non-latching)<sup>1</sup>, Sampling (based on time)

Off (disable unused relays and enable Interlock feature), Manual on/off control mode

**Secondary Functions<sup>2</sup>:** Pump alternation control (2 to 4 relays), Latching (requires manual acknowledge)

**Relay Reset:** User selectable buttons behind front panel or digital inputs.

1. Automatic reset only (non-latching), when input passes the reset point.
2. Automatic + manual reset at any time (non-latching)
3. Manual reset only, at any time (latching)
4. Manual reset only after alarm condition has cleared (latching)

*Note: Button behind front panel or digital input may be assigned to acknowledge relays programmed for manual reset.*

<sup>1</sup> Alarms are active only when the batch is running.

<sup>2</sup> These operations are not functional when the unit is being used as a batch controller with total set to yes

## Isolated 4-20 mA Transmitter Output

**Output Source:** Process variable (PV), max, min, set points 1-4, Modbus input, or manual control mode

**Scaling Range:** 1.000 to 23.000 mA for any display range

**Calibration:** Factory calibrated: 4.000 to 20.000 = 4-20 mA output

**Analog Out Programming:** 23.000 mA maximum for all parameters: Overrange, underrange, max, min, and break

**Accuracy:** ± 0.1% of span ± 0.004 mA

**Temperature Drift:** 0.4 µA/°C max from 0 to 65°C ambient,

0.8 µA/°C max from -40 to 0°C ambient

*Note: Analog output drift is separate from input drift.*

**Isolated Transmitter Power Supply:** Terminals I+ & R: 24 VDC ± 10%.

Isolated from the input at >500 V. May be used to power the 4-20 mA output or other devices. All models rated @ 40 mA max.

**External Loop Power Supply:** 35 VDC maximum

**Output Loop Resistance:**

Power Supply	Minimum	Maximum
24 VDC	10 Ω	700 Ω
35 VDC (external)	100 Ω	1200 Ω

## RS-485 Serial Communications Terminal

**Compatibility:** EIA-485

**Connectors:** Removable screw terminal connector

**Max Distance:** 3,937' (1,200 m) max

**Status Indication:** Separate LEDs for Power (P), Transmit (TX), and Receive (RX)

## Modbus® RTU Serial Communications

**Slave ID:** 1 - 247

**Baud Rate:** 300 - 19,200 bps

**Transmit Time Delay:** Programmable between 0 and 199 ms

**Data:** 8 bit (1 start bit, 1 or 2 stop bits)

**Parity:** Even, odd, or none with 1 or 2 stop bits

**Byte-to-Byte Timeout:** 0.01 - 2.54 seconds

**Turn Around Delay:** Less than 2 ms (fixed)

*Note: Refer to the Modbus Register Tables located at [www.predig.com](http://www.predig.com) for details.*

## Digital Input & Output Terminal

**Channels:** 4 digital inputs & 4 digital outputs

**Digital Input Logic High:** 3 to 5 VDC

**Digital Input Logic Low:** 0 to 1.25 VDC

**Digital Output Logic High:** 3.1 to 3.3 VDC

**Digital Output Logic Low:** 0 to 0.4 VDC

**Source Current:** 10 mA maximum output current

**Sink Current:** 1.5 mA minimum input current

**+5 V Terminal:** To be used as pull-up for digital inputs only. Connect normally open pushbuttons across +5 V & DI 1-4.

**WARNING! DO NOT use +5 V terminal to power external devices.**



# PD2-6210 / PD2-6310 Helios Batch Controllers

## CONNECTIONS

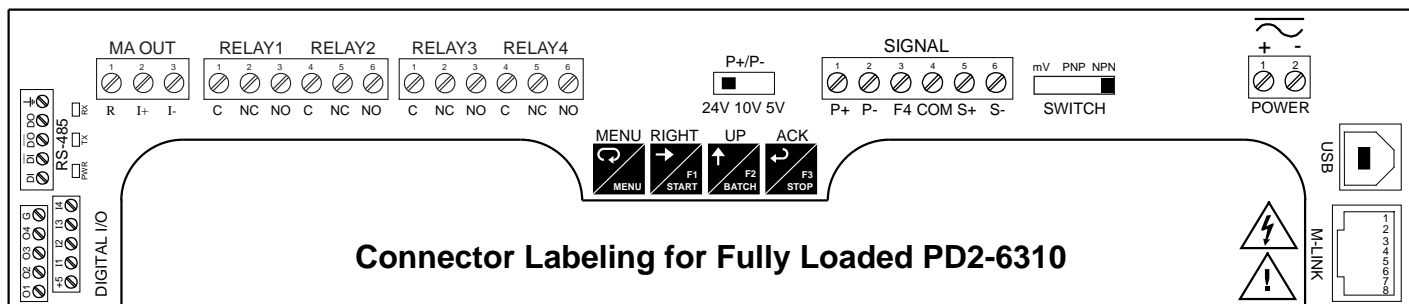
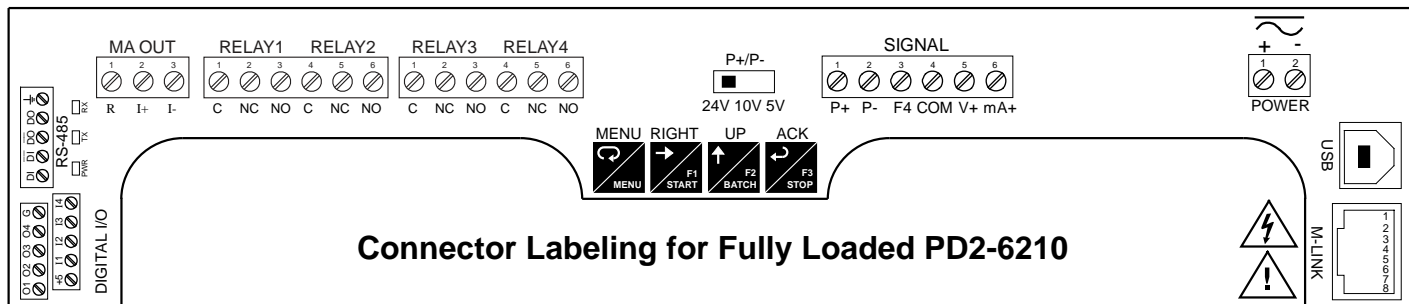

## DIMENSIONS

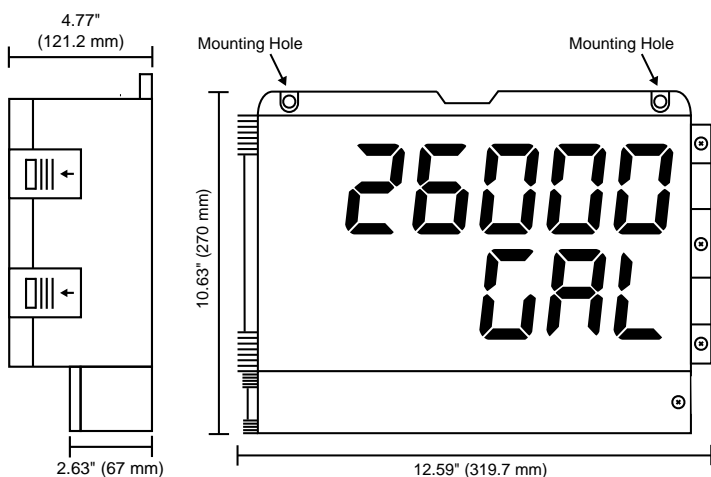

## ORDERING INFORMATION

Helios PD2-6210 Batch Controller Models		
85-265 VAC Model	12-24 VDC Model	Options Installed
PD2-6210-6H0	PD2-6210-7H0	No Options
PD2-6210-6H7	PD2-6210-7H7	4 Relays & 4-20 mA Output

Note: 24 V Transmitter power supply standard on all models.

Helios PD2-6310 Batch Controller Models		
85-265 VAC Model	12-24 VDC Model	Options Installed
PD2-6310-6H0	PD2-6310-7H0	No Options
PD2-6310-6H7	PD2-6310-7H7	4 Relays & 4-20 mA Output

Note: 24 V Transmitter power supply standard on all models.

Accessories	
Model	Description
PDA6260	Pipe Mounting Kit
PDA7485-I	RS-232 to RS-422/485 Isolated Converter
PDA7485-N	RS-232 to RS-422/485 Non-Isolated Converter
PDA8485-I	USB to RS-422/485 Isolated Converter
PDA8485-N	USB to RS-422/485 Non-Isolated Converter
PDAPLUG2	Plastic Conduit Plug
PDX6901	Suppressor (snubber): 0.01 μF/470 Ω, 250 VAC

Your Local Distributor is:  
 Order from:

**C A Briggs Company**

622 Mary Street; Suite 101  
 Warminster, PA 18974

Phone: 267-673-8117 - Fax: 267-673-8118

Sales@cabriggs.com - www.cabriggs.com

### Disclaimer

The information contained in this document is subject to change without notice. Precision Digital Corporation makes no representations or warranties with respect to the contents hereof, and specifically disclaims any implied warranties of merchantability or fitness for a particular purpose. ©2016-2018 Precision Digital Corporation. All rights reserved.

LDS2-6210\_C 08/18