

Vibrating Level Switch for Liquids

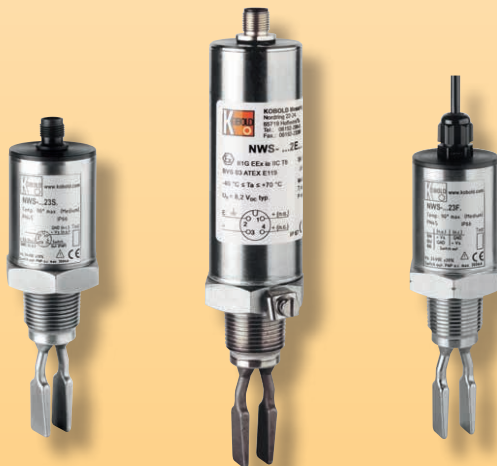

measuring
•
monitoring
•
analyzing

NWS



- Repeatability: ± 1 mm
- p_{max} : 650 PSIG
- t_{max} : 265 °F,
300 °F (for CIP Process)
- Connections:
NPT, Flange, Hygienic
- Material:
316L Stainless Steel
- Viscosity:
Max. 5000 cSt
- No Moving Parts
- ATEX/IECEX Version



Order from: **C A Briggs Company**

622 Mary Street; Suite 101; Warminster, PA 18974

Phone: 267-673-8117 - Fax: 267-673-8118

Sales@cabriggs.com - www.cabriggs.com

KOBOLD Instruments, Inc.
1801 Parkway View Drive
Pittsburgh, PA 15205

Description

The KOBOLD liquid level switch NWS is designed as a 2 and 3-wire switch and can be universally used in tanks and pipelines. The NWS operates on the tuning fork principle in air at resonance frequency. A piezoelectric crystal is used for excitation of oscillations and for monitoring the actual oscillation frequency. When the fork is immersed in liquid, the frequency changes: this change is detected electronically and the output signal is changed. The NWS operates as a 2-wire switch in series with the load. The simple electronic switch is operated by the liquid. The NWS can also be connected to a PLC through a third terminal. The NWS has an output state indicator with an LED that can be seen through a lens in the cover. The LED flashes about once a second when the NWS has switched off and is permanently illuminated when the NWS is switched on. The LED is an optical confirmation that the NWS is working correctly and the condition of the wet side is correctly displayed. The NWS can be set as upper or lower limiter with a mode selector.



Applications

- Oils and Foamed Oils
- Water
- Paints and Transparent Inks
- Sauces
- Milk
- Liquids Containing Carbon Dioxide
- Hygienic and Sterile Applications
- CIP Cycles up to 300 °F.

ATEX/IECEX Version:

- Type of Protection: Intrinsically Safe ia
- Designation: II 1G Exia IIC T6 Ga
IECEX Exia IIC T6 Ga
- For Use in Connection with Intrinsically Safe Isolation Switching Amplifier According to IEC 60947-5-6

Technical Data

Materials

- Fork:** 316L Stainless Steel
- Connection:** 316L Stainless Steel
- Housing:**
NWS-..20..: PAG, Fiberglass-reinforced Cover with Window, 330° Rotatable
- All Other Types:** 304 Stainless Steel

- Connections:** NPT-thread, Tri-Clamp®, Sanitary Connection, Flange ANSI B 16.5 - 1", 300 lbs, Flange ANSI B 16.5 - 2", 300 lbs

Protection:

- Plastic Housing:** IP 65 (NWS-..200)
- SS Housing/ Plug Connection:** IP 67
- SS Housing/ Cable Connection:** IP 68

Max. Operating Pressure:

650 PSIG Flange Connection:
See Pressure Steps

Max. Media Temp.:

265 °F (NWS-..200..)
194 °F (for all other NWS)
Short-time 300 °F for CIP (Valid for all Models NWS)

Min. Media Density:

800 g/l

Ambient Temperature:

-4...158 °F

Min. Immersion Depth for Switch Points:

0.48" (Marker on Fork)

Power Supply

- NWS-..200..: 24...240 V_{DC/AC} (50/60 Hz); 2-wire; 24 V_{DC}, 3-wire

Leakage Current in Off State:

<3.5 mA

NWS-..23/24/2W/ 2H..:

24 V_{DC}, 3-wire

NWS-..2E.. (ATEX):

Isolation Switching Amplifier to IEC 60947-5-6 (Namur) Necessary (for example: KFD2-SR2-EX1.W or KFA6-SR2-EX1.W)

Delay:

1 s wet /dry
1 s dry / wet

Viscosity:

5000 cSt max. at 77 °F
(Influence on the Response Time)

Hysteresis:

4 mm Vertical, 1 mm Horizontal

Repeatability:

± 1 mm

Weight:

1.1 lb (¼" NPT)

Electrical Connection

NWS-..200..
 2-wire 24-240 V_{AC/DC},
 Serial Load,
 $I_{max} \leq 400 \text{ mA}$

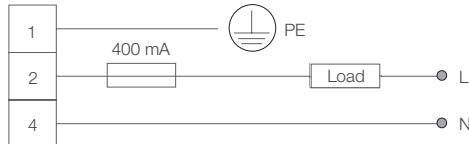

NWS-..200..
 3-wire, $V_S = 24 \text{ V}_{DC}$
 Output PNP: $U_{HIGH} - 16.5 \text{ V}$;
 $U_{LOW} - 2.5 \text{ V}$; $I_{max} \leq 400 \text{ mA}$

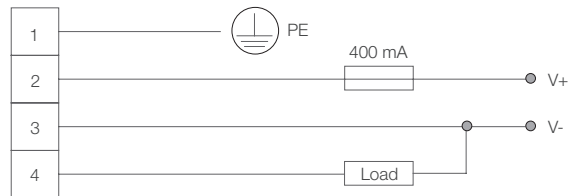

Wiring Diagram

NWS-..23/24 (24 V_{DC})

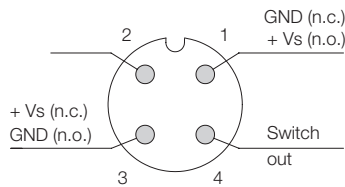

Color of Core	NWS-.. 23/24
Brown	+ Vs (n.o.) / GND
Blue	GND / + Vs (n.c.)
Black	Switch Out

NWS-..2E.. (ATEX)

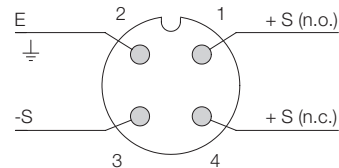

Lead- / Pin Number	NWS-.. 2E (ATEX)
1	+ S (n.o.)
2	Ground
3	- S
4	+ S (n.c.)

Wiring Examples NWS-..2E.. with Power Supply Unit acc. to IEC 60947-5-6

Plug M12x1

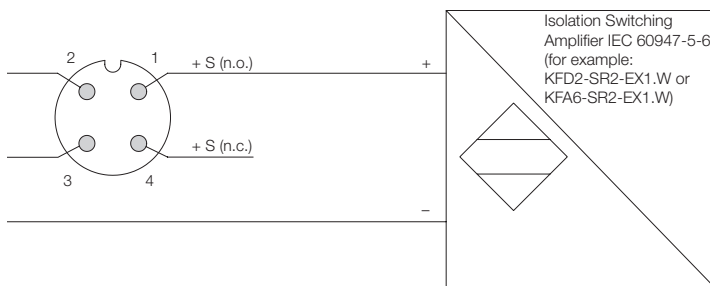

Cable 1.5 m

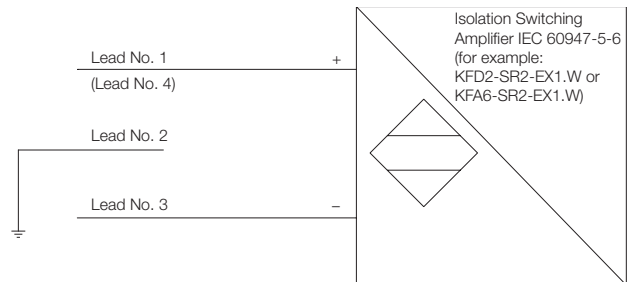



Vibrating Level Switch Model NWS

Order Details (Example: **NWS-N20 200 0070**)

Connection	Model	Electrical Connection	Sensor Version
3/4" NPT Male Thread	NWS-N20..	<p style="text-align: center;">Plastic Housing</p> <p>..200.. = 24...240 V_{AC/DC} Cable Gland/Terminal Connection</p> <p>..20C.. = 24...240 V_{AC/DC} 1/2" NPT Conduit/Terminal Connection</p> <p>..20S.. = 24...240 V_{AC/DC} Plug M12x1/Terminal Connection with 2 m (6') Cable Included</p> <p style="text-align: center;">St. Steel Housing / Plug Connection</p> <p>..23S.. = 24 V_{DC}, PNP, Plug M12x1</p> <p>..24S.. = 24 V_{DC}, NPN, Plug M12x1</p> <p>..2ES.. = ATEX-approval, Plug M12x1</p> <p style="text-align: center;">St. Steel Housing / Cable Connection</p> <p>..23F.. = 24 V_{DC}, PNP, 1.5 m (5') Cable</p> <p>..24F.. = 24 V_{DC}, NPN, 1.5 m (5') Cable</p> <p>..2EF.. = ATEX Approval, 1.5 m (5') Cable</p>	<p>..0060 = 60 mm (2.36") (only for NWS-T)</p> <p>..0070 = 70 mm (2.75") Standard Version, Short (not for NWS-T)</p> <p>..0117¹⁾ = 117 mm (4.60") Extended</p> <p>..0300¹⁾ = 300 mm (11.8") Sensor</p> <p>..0500¹⁾ = 500 mm (19.68") Sensor</p> <p>..1000¹⁾ = 1000 mm (39.36") Sensor</p> <p>..XXXX¹⁾ = Please Specify Special Length 4-digits in millimeters, (3000mm (118.1") max.)</p>
1" NPT Male Thread	NWS-N25..*		
1" ANSI Flange	NWS-A25..		
2" ANSI Flange	NWS-A50..*		
Tri-Clamp [®] DN 40	NWS-T40..		
Tri-Clamp [®] DN 50	NWS-T50..		
Accessory Cable Options for Electrical Connection 23S, 24S, or 2ES			
<p>807.037 = Mating 4-Pin Micro-DC Plug with 2 meter (6 foot) Cable</p> <p>807.037/5M = Mating 4-pin Micro DC Plug with 5 meter (16 foot) Cable</p> <p>807.037/10M = Mating 4-pin Micro DC Plug with 10 meter (32 foot) Cable</p>			

¹⁾ only models marked with * are available with sensors in extended version

Dimensions

NWS-..200

24...V_{AC/DC}
Plastic Housing

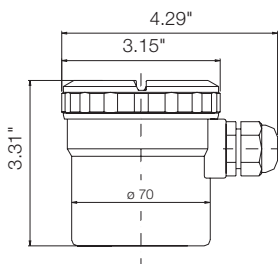

NWS-..23S/24S

24 V_{DC}
Plug Connection

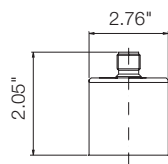

NWS-..23F/24F

24 V_{DC}
Cable Connection

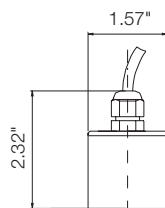

NWS-..2ES

ATEX
Plug Connection

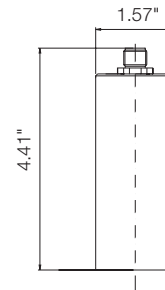

NWS-..2EF

ATEX
Cable Connection

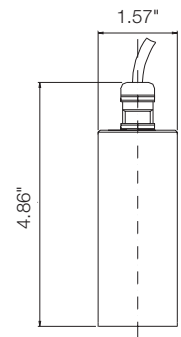

Dimensions (continued)

NWS-..0070
(Standard, Short)

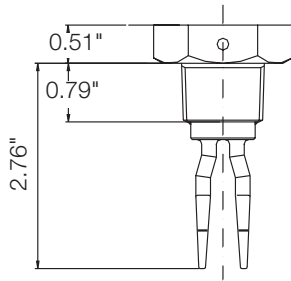

NWS-N25..0117
(Extended)

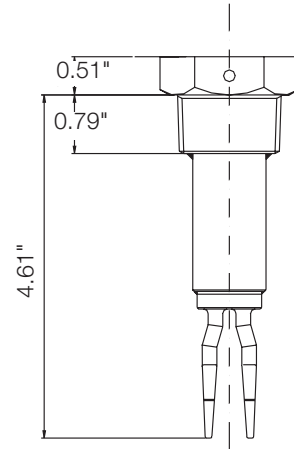

NWS-T..
Tri-Clamp®

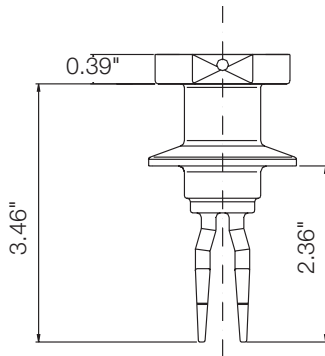

NWS-A..
Flange Version

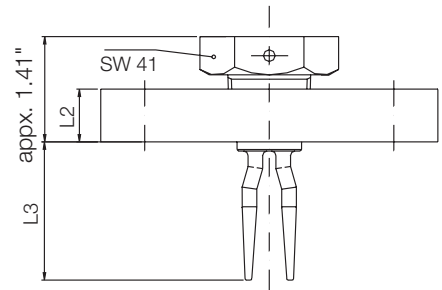

	L 2	L 3
ANSI 1" 300 lbs	0.69"	approx. 1.61"
ANSI 2" 300 lbs	0.88"	approx. 3.62"