

# PRX Series – Compact Switches

## PRX-10, PRX-20, PRX-30, PRX-40, PRX-50, PRX-70

- Easy to install
- No standby power requirements
- Reliable for over 1 million cycles
- Interchangeable with existing sensors
- Hermetically sealed for longer performance

The PRX series from Gems offers a versatile line of low cost, general purpose proximity sensors designed for dry applications. Constructed out of ABS and UL approved material, the PRX series has no standby power requirements and no moving parts. Proximity sensors are hermetically sealed for long lasting performance and are easy to install for a variety of applications.

### Specifications

<b>Housing Material</b>	ABS
<b>Operating Temperature</b>	32°F to 212°F (0°C to 100°C)
<b>Switch</b>	SPST, N.O.
<b>Voltage, Max.</b>	160 Vdc
<b>Current, Max.</b>	0.5 Amps
<b>Vibration Resistance</b>	10 to 55 Hz

### Typical Applications

- General purpose
- Household appliances
- Security systems
- Door interlocks
- Safety interlocks
- Position indication
- Equipment automation

### PRX-10

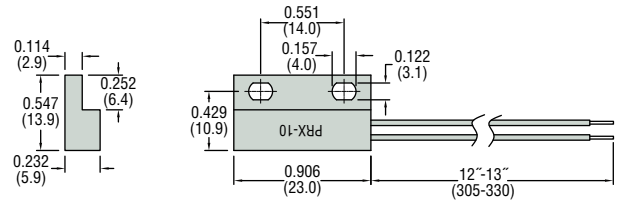

### PRX-20

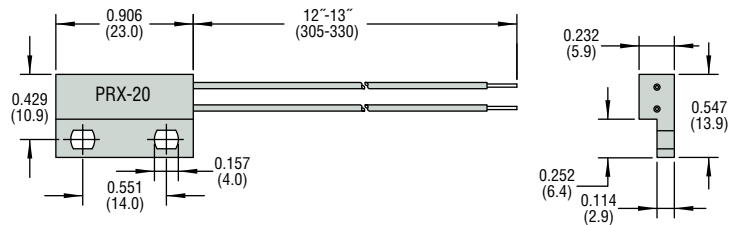

### PRX-30

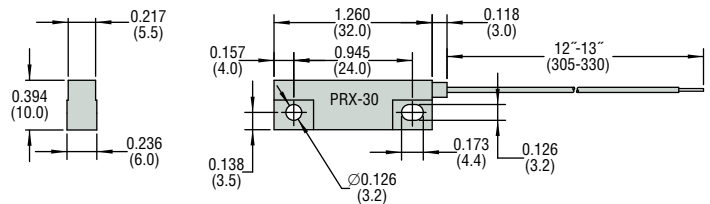

### PRX-40

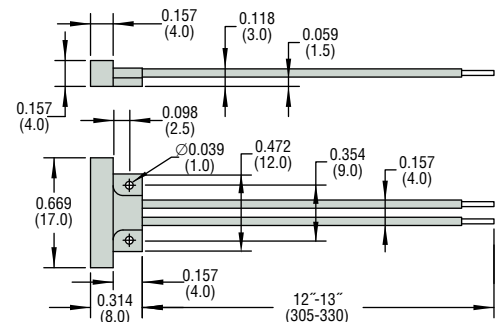
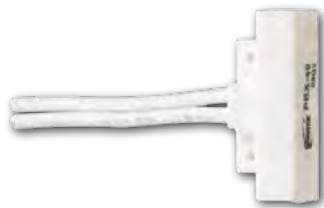

PRX-50

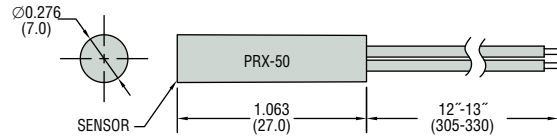

PRX-70

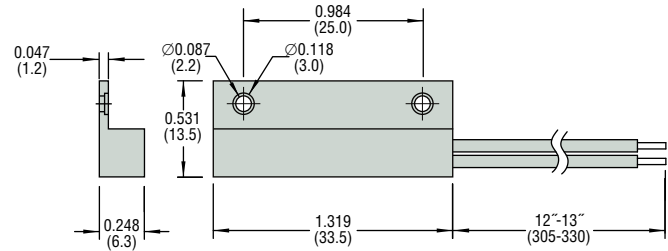

How To Order – Switches

Select by Part Number based on operational requirements. All proximity switches below come with matching magnets included.

Series	Operating Temperature	Contact Rating	Switch Open Distance, Max.	Switch Close Distance, Min.	Part Number
PRX-10	14°F to 176°F (-10°C to +80°C)	10 VA	1.18 inch (30 mm)	0.63 inch (16 mm)	225951
PRX-20	14°F to 176°F (-10°C to +80°C)	10 VA	1.18 inch (30 mm)	0.63 inch (16 mm)	225952
PRX-30	14°F to 176°F (-10°C to +80°C)	10 VA	1.18 inch (30 mm)	0.63 inch (16 mm)	225953
PRX-40	14°F to 176°F (-10°C to +80°C)	10 VA	0.79 inch (20 mm)	0.35 inch (9 mm)	225954
PRX-50	14°F to 140°F (-10°C to +60°C)	10 VA	1.38 inch (35 mm)	0.71 inch (18 mm)	225955
PRX-70	14°F to 140°F (-10°C to +60°C)	50 VA	1.02 inch (26 mm)	0.47 inch (12 mm)	225956

Notes:

- Product options include: Lead length, Activation Magnet and 22 Gage Wire. Please contact Gems for these options.
- Lead time 2 weeks. A minimum piece order is required; please contact factory .

Actuating Magnets

Ferrite

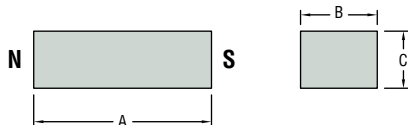

Neo

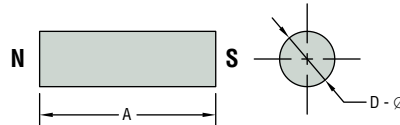

How To Order – Magnets

Magnets for the above Proximity Switch series can be ordered separately.

Specify Part Number based on series switch with which the magnet is to be paired.

Switch Series	Magnet Type	Dimensions – inch (mm)				Part Number
		A	B	C	D – Ø	
PRX-10 PRX-20 PRX-30	Ferrite	1 (25.5)	0.43 (11)	0.35 (9)	—	226618
PRX-40	Neo	0.62 (15.8)	—	—	0.11 (2.8)	226621
PRX-50	Neo	0.79 (20.1)	—	—	0.25 (6.3)	226622
PRX-70	Neo	1.13 (28.6)	—	—	0.18 (4.7)	226623

Order from: 7 5 6f [ g 7 ca dUbn 622 Mary Street; Suite 101 - Warminster, PA 18974

# PRX-100 Series

## Heavy Duty, General Purpose

- Easy to install
- No standby power requirements
- Reliable for over 1 million cycles
- Interchangeable with existing sensors
- Hermetically sealed for longer performance

### Specifications

<b>Housing Material</b>	Noryl™ (PPO)
<b>Operating Temperature</b>	-40°F to +194°F (-20°C to +90°C)
<b>Pressure</b>	Atmospheric
<b>Approvals</b>	cULus File # E305671

### Typical Applications

- General Purpose
- Household Appliances
- Security systems
- Door interlocks
- Safety interlocks
- Position indication
- Equipment automation

### How To Order – Two Steps: Select Switch and Magnet

**Step 1:** Configure Switch Part Number from options below.

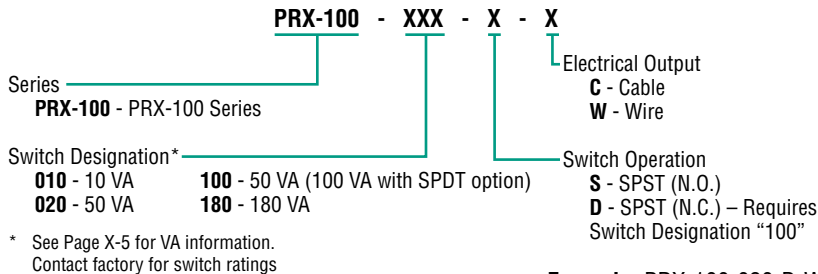

**Example:** PRX-100-020-D-W

**Step 2:** Select an Actuating Magnet to pair with Switch.

PRX-100 Series actuating magnets are available in both housed assemblies and as bare magnets (See Page K-5).

### Configuration

#### Type 1 Assembly

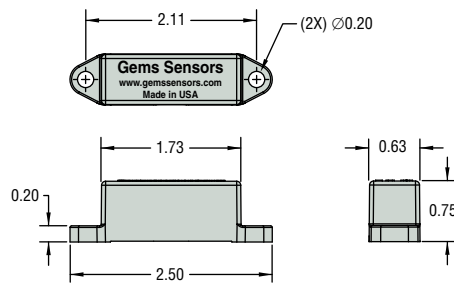

#### Type 2 Assembly

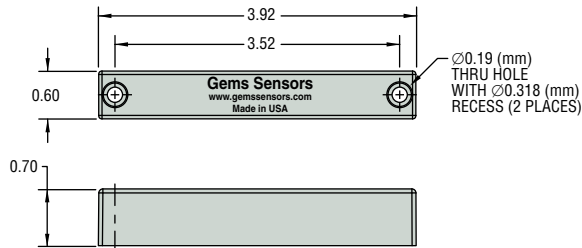

### How to Order

**Magnets for the above Proximity Switches are ordered separately.**  
 Select by Configuration, Magnet Type and Size.

Configuration	Magnet Type	Magnet Size		Part Number
		A – Length	B – Diameter	
Type 1 Assembly	Alnico 5	1.5" (38.1 mm)	3/8" (9.5 mm)	<b>217302</b>
	Neo N35H	1.5" (38.1 mm)	3/8" (9.5 mm)	<b>217310</b>
Type 2 Assembly	Alnico 5	2.5" (63.5 mm)	3/8" (9.5 mm)	<b>217301</b>
	Alnico 5	1.5" (38.1 mm)	3/8" (9.5 mm)	<b>222055</b>
	Neo N35H	1.5" (38.1 mm)	3/8" (9.5 mm)	<b>222056</b>



### Dimensions

#### Type C – Cable Output

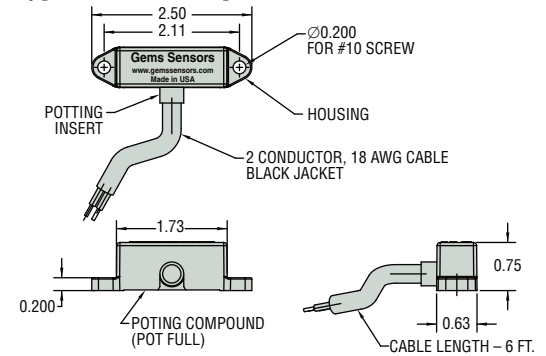

#### Type W – Wire Output

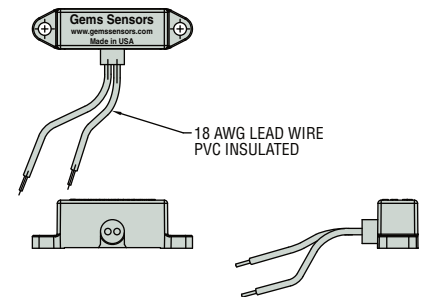

# PRX-300 Series

## Mid Range General Purpose

- Stress relief technology for reed switch protection
- Easy to install
- No standby power requirements
- Reliable for over 1 million cycles
- Interchangeable with existing sensors
- Hermetically sealed for longer performance
- Normally Open (No magnetic field)

The compact size of the PRX-300 series offers a variety of low cost, high performance proximity switches. Constructed out of robust 33% glass filled nylon the PRX-300 series has no standby power requirements and no moving parts. Proximity switches are hermetically sealed for long lasting performance and are easy to install and adjust for a variety of customer applications.

### Specifications

<b>Housing Material</b>	Nylon 33% GF
<b>Operating Temperature</b>	32°F to 212°F (0°C to 100°C)
<b>Pressure</b>	Atmospheric
<b>Switch</b>	SPST, N.O.
<b>Voltage, Max.</b>	250 Vdc
<b>Current, Max.</b>	1.0 A
<b>Approval</b>	U.L. Recognized

### Typical Applications

- General Purpose
- Household Appliances
- Security systems
- Door interlocks
- Safety interlocks
- Position indication
- Equipment automation

### PRX-300

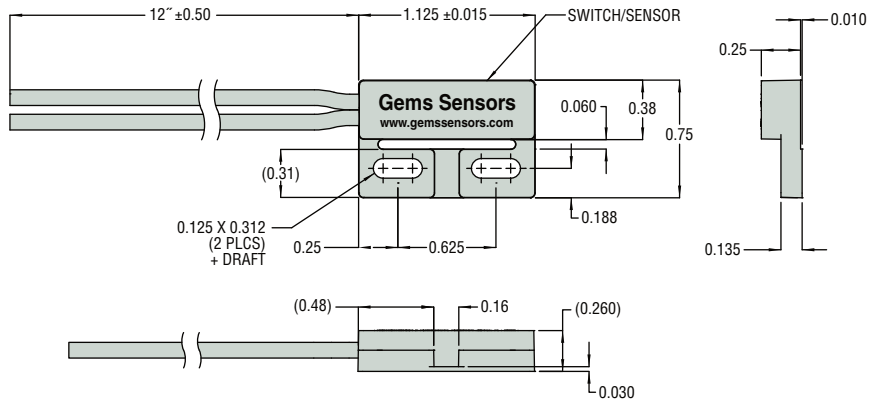

### PRX-310

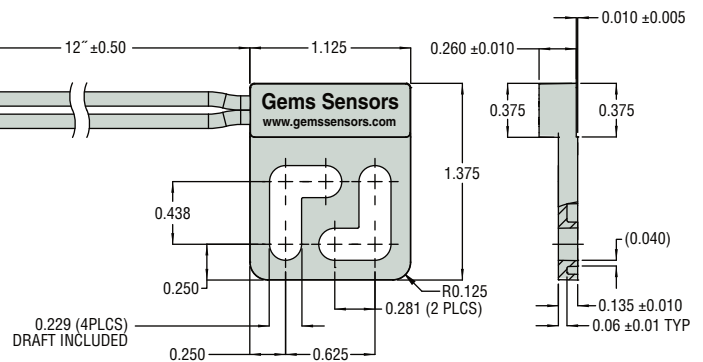

### PRX-320

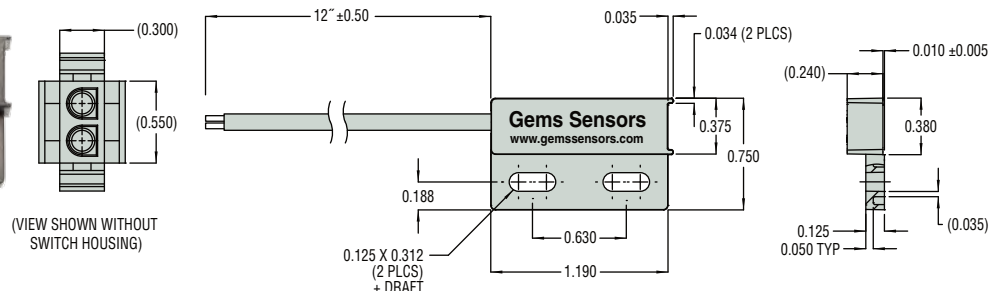

Order from: 7 5 6 f [ [ g 7 ca dUbm 622 Mary Street; Suite 101 - Warminster, PA 18974

## How To Order – Switches

Select by Part Number based on operational requirements.

Series	Housing Material	Operating Temperature	Contact Rating	Switch Actuation Distance	Part Number
PRX-300	Nylon 33% GF	32°F to 212°F (0°C to 100°C)	50 VA	0.75 inch (19 mm)	<b>225815</b>
PRX-310	Nylon 33% GF	32°F to 212°F (0°C to 100°C)	50 VA	0.70 inch (17.8 mm)	<b>225820</b>
PRX-320	Nylon 33% GF	32°F to 212°F (0°C to 100°C)	50 VA	0.5 inch (12.7 mm)	<b>225830</b>

Notes:

- Product options include: Lead length, Activation Magnet and 22 Gage Wire. Please contact Gems for these options.
- Lead time 2 weeks.

## Actuating Magnets

Bare Magnet

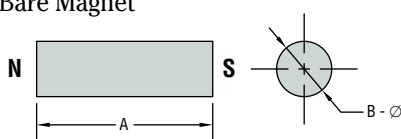

## How to Order

Magnets for the above Proximity Switches series are ordered separately.

Select by Configuration, Magnet Type and Size.

Configuration	Magnet Type	Magnet Size		Part Number
		A – Length	B – Diameter	
Bare Magnet	Alnico 5	1" (25.4 mm)	3/16" (4.8 mm)	<b>217311</b>
		1.5" (38.1 mm)	3/8" (9.5 mm)	<b>217303</b>
		2.5" (63.5mm)	3/8" (9.5 mm)	<b>217909</b>
		3" (76.2mm)	1/2" (12.7 mm)	<b>220551</b>
	Neo N35H	1" (25.4 mm)	3/16" (4.8 mm)	<b>217304</b>
				<b>217309</b>
		1" (25.4 mm)	3/8" (9.5 mm)	<b>220999</b>
		1.5" (38.1 mm)	3/8" (9.5 mm)	<b>220753</b>