

# XLS-1 — Ultrasonic Level Sensor

- ▶ No Moving Parts
- ▶ Zero Maintenance
- ▶ Ignores Condensation on Sensor
- ▶ Will Not Sense Foam as Liquid
- ▶ Microcontroller-Based Electronics

XLS-1 ultrasonic level sensors are compatible with water-based and hydrocarbon-based liquids, and are perfect for applications where condensation may affect other sensing technologies. The XLS-1 is an ideal solution for sensing liquid level in generators, water tanks, radiators, printers, and other industrial applications. XLS-1 ultrasonic level switches expand the Gems catalog of solid-state level sensors.

## Specifications

<b>Probe Length</b>	1.25" (including threads)
<b>Fluid Compatibility</b>	Water, Water-based medias, Hydrocarbon-based chemicals, not compatible with high-viscosity liquids
<b>Materials</b>	
<b>Housing</b>	316L Stainless Steel
<b>O-Ring Seal*</b>	EPDM; NBR, Silicon, Kalrez® or Chemraz® available (Consult Factory)
<b>Connector Housing</b>	30% Glass-filled Polyester
<b>Performance</b>	
<b>Accuracy</b>	±1 mm from centerline
<b>Repeatability</b>	±1 mm
<b>Temperatures</b>	
<b>Fluid</b>	-40°F to +257°F (-40°C to +125°C)
<b>Ambient</b>	-40°F to +185°F (-40°C to +85°C)
<b>Pressures</b>	
<b>Operating</b>	0 to 250 psig
<b>Burst</b>	1000 psig
<b>Environmental</b>	
<b>Ingress</b>	IP67 Per IEC60529 IP6K9K Per DIN40050-9 (sensor only)
<b>Vibration</b>	Per IEC 60068-2-6; 20 m/s <sup>2</sup> , 10-55 Hz; MIL-STD-202G, Method 204D, 10G, 57-2000 Hz
<b>Shock</b>	Per IEC 60068-2-27; 15G, 11ms
<b>Audio Frequency Immunity</b>	Per MIL 461D, CS101
<b>EMC Immunity</b>	IEC 61326-1; EN61000-4-(2 thru 6)
<b>Input Power</b>	5-28 VDC regulated power, max supply current 20 mA
<b>Outputs</b>	Open collector, sinking or sourcing output Open collector specs 30 VDC, 30mA max
<b>Electrical Interface</b>	3 Pin Deutsch DT Series Connector, 18 AWG wire or cable
<b>Mechanical Interface</b>	1/4" NPT, 1/2" NPT, M12x1.0, M12x1.5, 1/2"-20, G1/4", others available upon request
<b>Mounting Orientation</b>	Mounted Horizontally ±60 degrees
<b>Approvals</b>	CE (EMC 2004/108/EC) and RoHS, UL/CUL Recognized
<b>Calibration</b>	None required

\* Where applicable.

## Wiring Diagram

### Sinking

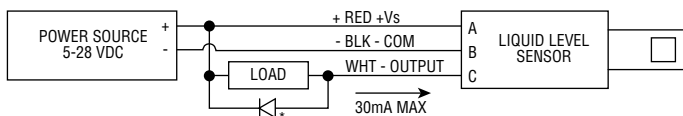

### Sourcing

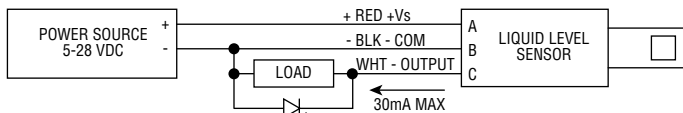

\* For inductive loads, use diode suppression.



## Dimensions

### 3-PIN Deutsch Connector

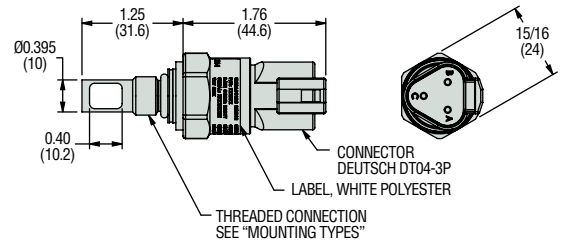

### 3-Wire Output

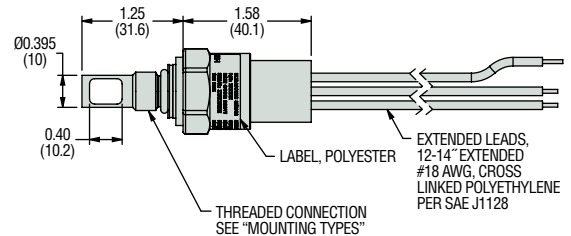

### PVC Cable

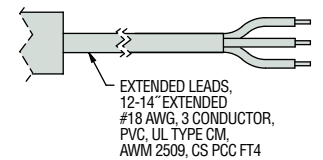

## Mounting Attitude

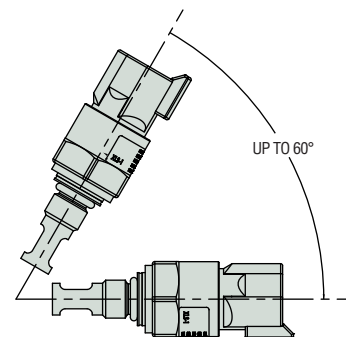

Mounting Types

SAE

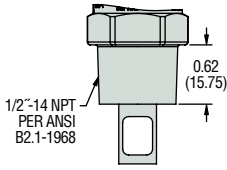
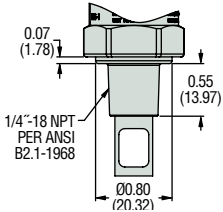
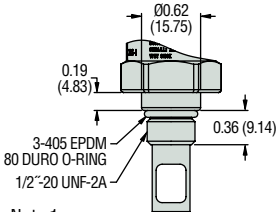
1/2"-14 NPT	1/4"-18 NPT	1/2"-20 per SAE J1926-3
 <p>1/2"-14 NPT PER ANSI B2.1-1968</p> <p>0.62 (15.75)</p>	 <p>0.07 (1.78)</p> <p>1/4"-18 NPT PER ANSI B2.1-1968</p> <p>0.55 (13.97)</p> <p>Ø0.80 (20.32)</p>	 <p>Ø0.62 (15.75)</p> <p>0.19 (4.83)</p> <p>3-405 EPDM 80 DURO O-RING</p> <p>1/2"-20 UNF-2A</p> <p>0.36 (9.14)</p> <p>See Note 1</p>

BSP & Metric

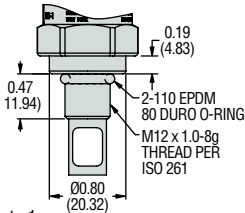
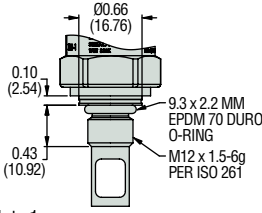
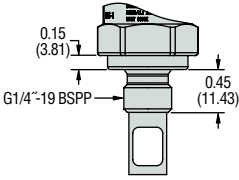
M12 x 1.0	M12 x 1.5 per ISO6149-3	G1/4"-19 BSPP
 <p>0.19 (4.83)</p> <p>2-110 EPDM 80 DURO O-RING</p> <p>M12 x 1.0-8g THREAD PER ISO 261</p> <p>Ø0.80 (20.32)</p> <p>0.47 (11.94)</p> <p>See Note 1</p>	 <p>Ø0.66 (16.76)</p> <p>0.10 (2.54)</p> <p>9.3 x 2.2 MM EPDM 70 DURO O-RING</p> <p>M12 x 1.5-6g PER ISO 261</p> <p>0.43 (10.92)</p> <p>See Note 1</p>	 <p>0.15 (3.81)</p> <p>G1/4"-19 BSPP</p> <p>0.45 (11.43)</p> <p>See Note 2</p>

inch  
(mm)

How To Order

Select a Part Number based on mounting type, connection and actuation condition.

Actuation Condition	Electrical Connection	Mounting Type					
		M12 x 1.0 (TYPE 10) <sup>1</sup>	1/2"-14 NPT (TYPE 12)	1/4"-18 NPT (TYPE 14)	M12 x 1.5 per ISO6149-3 (TYPE 15) <sup>1</sup>	1/2"-20 per SAE J1926-3 (TYPE 20) <sup>1</sup>	G1/4"-19 BSPP (TYPE 24) <sup>2</sup>
Wet Sink	Integral 3-pin Deutsch® Connector	247670	247690	247700	247680	247660	250010
	18 AWG, 12"-14" Extended Flying Leads	247740	247780	247800	247760	247720	250020
	12"-14" PVC Cable	247750	247790	247810	247770	247730	250030
Dry Sink	Integral 3-pin Deutsch® Connector	247675	247695	247715	247685	247665	250005
	18 AWG, 12"-14" Extended Flying Leads	247745	247785	247805	247765	247725	250015
	12"-14" PVC Cable	247755	247795	247815	247775	247735	250025
Wet Source	Integral 3-pin Deutsch® Connector	250830	250820	250840	250850	250870	250890
	18 AWG, 12"-14" Extended Flying Leads	250930	250920	250940	250950	250970	250990
	12"-14" PVC Cable	251030	251020	251040	251050	251070	251090
Dry Source	Integral 3-pin Deutsch® Connector	250835	250825	250845	250815	250875	250895
	18 AWG, 12"-14" Extended Flying Leads	250935	250925	250945	250855	250975	250995
	12"-14" PVC Cable	251035	251025	251045	250915	251005	250955

Notes:

1. Supplied with EPDM O-ring. Consult factory for alternate O-ring materials.
2. Designed for use with Dowty Bonded Seal. Not supplied.

LEVEL SWITCHES - SINGLE POINT