

IOM

LVP180613 Rev. A



---

# Pulse Point™ II Series Installation & Operation Manual





# Pulse Point™ II Series Installation & Operation Manual

## CONTENTS

<b>I. HANDLING &amp; STORAGE</b> .....	<b>1</b>
Inspection and Handling	
Disposal and Recycling	
Storage	
<b>II. GENERAL SAFETY</b> .....	<b>2</b>
Authorized Personnel	
Use	
Misuse	
<b>III. PRODUCT DESCRIPTION</b> .....	<b>3</b>
Function	
Applications	
Features	
Technical Specifications	
Approvals	
<b>IV. MECHANICAL INSTALLATION</b> .....	<b>5</b>
Guidelines	
Figure 1. Mounting Orientation	
Figure 2. Mounting in Relation to Flow of Material	
Figure 3. Index Mark Positioning	
Mounting Considerations	
<b>V. ELECTRICAL INSTALLATION</b> .....	<b>7</b>
General Safety	
Disconnect Requirements for Permanently Installed Equipment	
Protective Earth Ground	
Conduit Cable Connection	
Electrical Connections	
LP II Series Integral Model Only	
LP II Series Remote Model Only	
Figure 4. LP II Series - Integral Enclosure with Cover Removed - STANDARD	
Figure 5. LP II Series - Integral Enclosure with Cover Removed - ADVANCED	
Figure 6. Power and Ground Connections	
Figure 7. Main Relay Connections	
Figure 8. Auxiliary Relay Connections - ADVANCED ONLY	
Figure 9. LP II Series - Remote Enclosure with Cover Removed - STANDARD	
Figure 10. LP II Series - Remote Enclosure with Cover Removed - ADVANCED	
Figure 11. LP II Series Remote Connection Diagram	

<b>VI. SET-UP .....</b>	<b>15</b>
Operation	
Product Overview - STANDARD	
Figure 12. Switch Functions, Standard	
Product Overview - ADVANCED	
Figure 13. Switch Functions, Advanced	
Build Up Detection	
Fail-Safe Selection	
Figure 14. Fail-Safe Operation	
Time Delay Settings - STANDARD	
Time Delay Settings - ADVANCED	
Sensitivity Settings - STANDARD	
Sensitivity Settings - ADVANCED	
Liquid/Solid Interface - ADVANCED ONLY	
Test - ADVANCED ONLY	
Figure 15. Magnetic Fob	
<b>VII. MAINTENANCE .....</b>	<b>19</b>
<b>VIII. TROUBLESHOOTING .....</b>	<b>19</b>
<b>IX. DIMENSIONAL DRAWINGS.....</b>	<b>20</b>

## SAFETY SYMBOLS



### **WARNING:**

IDENTIFIES CONDITIONS OR PROCEDURES, WHICH IF NOT FOLLOWED, COULD RESULT IN SERIOUS INJURY. RISK OF ELECTRICAL SHOCK.



### **CAUTION:**

IDENTIFIES CONDITIONS OR PROCEDURES, WHICH IF NOT FOLLOWED, COULD RESULT IN SERIOUS DAMAGE OR FAILURE OF THE EQUIPMENT.

# Pulse Point II Series Installation & Operation Manual

## I. HANDLING AND STORAGE

### **SAVE THESE INSTRUCTIONS**

#### **INSPECTION AND HANDLING**

Do not dispose of the carton or packing materials.

Each package should be inspected upon receipt for damage that may have occurred due to mishandling during shipping. If the unit is received damaged, notify the carrier or the factory for instructions. Failure to do so may void your warranty. If you have any problems or questions, consult Customer Support at 800-778-9242.

#### **DISPOSAL AND RECYCLING**

This product can be recycled by specialized companies and must not be disposed of in a municipal collection site. If you do not have the means to dispose of properly, please contact for return and disposal instructions or options.

#### **STORAGE**

If the device is not scheduled for immediate installation following delivery, the following steps should be observed:

1. Following inspection, repackage the unit into its original packaging.
2. Select a clean dry site, free of vibration, shock and impact hazards.
3. If storage will be extended longer than 30 days, the unit must be stored at temperatures between 32° and 158° F (0° to 70° C) in non-condensing atmosphere with humidity less than 85%.



**CAUTION: DO NOT STORE A NON-POWERED UNIT OUTDOORS FOR A PROLONGED PERIOD.**

## II. GENERAL SAFETY

### **AUTHORIZED PERSONNEL**

All instructions described in the document must be performed by authorized and qualified service personnel only. Before installing the unit, please read these instructions and familiarize yourself with the requirements and functions of the device. The required personal protective equipment must always be worn when servicing this device.

### **USE**

The device is solely intended for use as described in this manual. Reliable operation is ensured only if the instrument is used according to the specifications described in this document. For safety and warranty reasons, use of accessory equipment not recommended by the manufacturer or modification of this device is explicitly forbidden. All servicing of this equipment must be performed by qualified service personnel only. This device should be mounted in locations where it will not be subject to tampering by unauthorized personnel.

### **MISUSE**

Improper use or installation of this device may cause the following:

- Personal injury or harm
- Application specific hazards such as vessel overfill
- Damage to the device or system

If any questions or problems arise during installation of this equipment, please contact Customer Support at 800-778-9242.

### III. PRODUCT DESCRIPTION

#### FUNCTION

The LP® II Series units are electronic, vibratory level controls designed for use in powders and granular solids. A vibrating “tuning fork” is used to sense the presence of material.

The tuning fork contains two piezoelectric crystal assemblies: one “transmit” and one “receive”. The Piezo crystals convert electrical signals to mechanical movement, and vice versa. High-voltage DC is applied to the transmit crystal cause the tines of the fork vibrate. This vibration is mechanically coupled to the receive crystal which produces a small electrical signal. The receive crystal will produce low voltage as long as the fork is vibrating.

If the fork stops vibrating, as it does when in contact with material in the vessel, the receive pulses stop. The electronics recognize this loss of signal and cause the main relay to change state.

#### APPLICATIONS

Unlike radio frequency and capacitance technology sensors, the LP II Series devices sense material using a mechanical principle and are therefore not affected by the dielectric constant of the material. These are ideal sensors in plastics, dust, shavings, and low-density powders and food. Material as light as 0.5 lbs/ft<sup>3</sup> (8 kg/m<sup>3</sup>) can easily be sensed. LP II can be used in any free flowing dry material up to 3/8” (9.525 mm) in particle size.

#### FEATURES

- Multiple mounting configurations, forks, and coatings available to suit almost any application
- Universal input power; AC or DC (see specifications for input ranges)
- No calibration required
- Adjustable time delay
- Selectable fail-safe operation (high or low level)
- Adjustable Sensitivity
- Build-up Detection - ADVANCED ONLY

## TECHNICAL SPECIFICATIONS

FUNCTIONAL	
Power Requirements Universal	(± 10%), 120-240 VAC 50/60 Hz or 24-48 VDC
Power Consumption - STANDARD	10 W AC; 3 W DC
Power Consumption - ADVANCED	11 W AC; 4 W DC
Fuse	Slow Blow, 1 A 300 V (Not User Serviceable)
Operating Temperature	
Electronics	-40° to 158° F (-40° to 70° C)
Fork	-55° to 302° F (-48° to 150° C) depending on fork
Outputs	
Main Relay	8 A DPDT @ 240 VAC or 30 VDC (resistive)
Auxiliary Relay - ADVANCED ONLY	0.46 A SPDT @ 150 VAC or 1 A @ 30 VDC
PERFORMANCE	
Pressure Rating	150 psi (10.5 kg/cm <sup>2</sup> ) with 1½" NPT; 5 psi (0.35 kg/cm <sup>2</sup> ) with mounting plate
Time Delay - STANDARD	Field Adjustable; 1-6 seconds
Time Delay - ADVANCED	Field Adjustable; 0-150 seconds
Fail Safe	Field Selectable; high/low level
Sensitivity	Minimum 0.5 lbs/ft <sup>3</sup> (8 kg/m <sup>3</sup> ); Field Adjustable
Maximum Particle Size	¾" (9.5 mm)
PHYSICAL	
Enclosure Material	Polyester or Epoxy Coated Aluminum or 304 SS
Fork Material	316 SS (standard); 316 SS with Teflon® coating
Dual Conduit Entry	¾" NPT or M20 x 1.5
Extended Pipe Material	Galvanized or 316 SS
Shipping Weight	Integral, non-extended 10 lb (4.5 kg)
Pollution Degree	2
Installation Category	II
Altitude	6,562 ft (2,000 m)

## APPROVALS & RATINGS

### UL (US and Canada):

- Ordinary Location Type 4X; IP66
- Hazardous Location, Type 4X; IP66 (Pending)
- Explosion Proof
- Dust Ignition Proof

### ATEX/IECex (Pending):

- Dust and Gas Categories

### CE

- Electromagnetic Compatibility Directive
- Low Voltage Directive



## IV. MECHANICAL INSTALLATION



**WARNING: VERY HIGH VOLTAGE IS PRESENT ON THE FORK TERMINALS.**

**REMOVE POWER FROM THE UNIT BEFORE INSTALLING, REMOVING, OR MAKING ADJUSTMENTS**

### GUIDELINES

The following precautions should be observed when installing and operating an LP II device:

- The installation and wiring of this product must comply with all national, federal, state, municipal and local codes that apply.
- The LP II Series are precision devices - handle carefully to prevent damage to the forks.
- Do not allow moisture to enter the electronics enclosure. Conduit should slope downward from the LP II housing. Install drip loops (or drain fitting) and seal conduit with silicone rubber product.
- The resonant frequency of the forks is 85 Hz ( $\pm 10\%$ ); locations subject to this vibration frequency should be avoided.



**CAUTION: WHETHER MOUNTING DIRECTLY THROUGH A SIDE WALL, OR PIPE EXTENDED AND MOUNTED VERTICALLY THROUGH THE TOP OF A VESSEL, NEVER ATTEMPT TO MOUNT THROUGH A FULL COUPLING.**



**CAUTION: ATTEMPTING TO TIGHTEN THE UNIT BY ROTATING THE HOUSING OR FORKS MAY DAMAGE THE UNIT AND VOID THE WARRANTY.**

The LP II unit must be located at the position where level indication is desired. The forks may be mounted through the top or side wall of the vessel. To ensure reliable operation, observe the following guidelines when choosing the mounting location.

- DO NOT mount the forks in an area where they can contact the vessel.
- The forks assembly must be horizontal or pointing downward. DO NOT mount the forks pointing upward.
- If the unit is to be used with powders, it should be installed vertically, or at a downward angle that exceeds the angle of repose to reduce material build-up on the forks.

**Figure 1. Mounting Orientation**

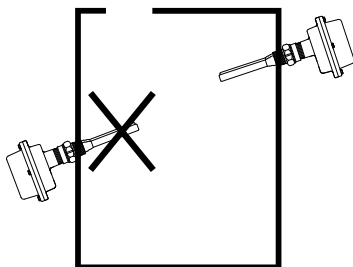



**CAUTION: THE MAXIMUM ALLOWABLE DOWNWARD FORCE ON THE FORKS IS 88 LBS (40 KG).**

To calculate the maximum solids head height above a horizontally mounted fork, use the following equation:

$$\text{Maximum height of material (ft)} = 2200 / \text{bulk density (lbs/ft}^3\text{)}$$

Do not mount the fork directly in the flow of material. If necessary, use a baffle to protect the fork from falling material. The baffle should be placed 6 to 8 inches above the fork so that material will not become packed between the fork and the baffle.

If using a remote unit, remote turtle cannot be mounted more than 100 feet away.

**Figure 2. Mounting In Relation To Flow of Material**

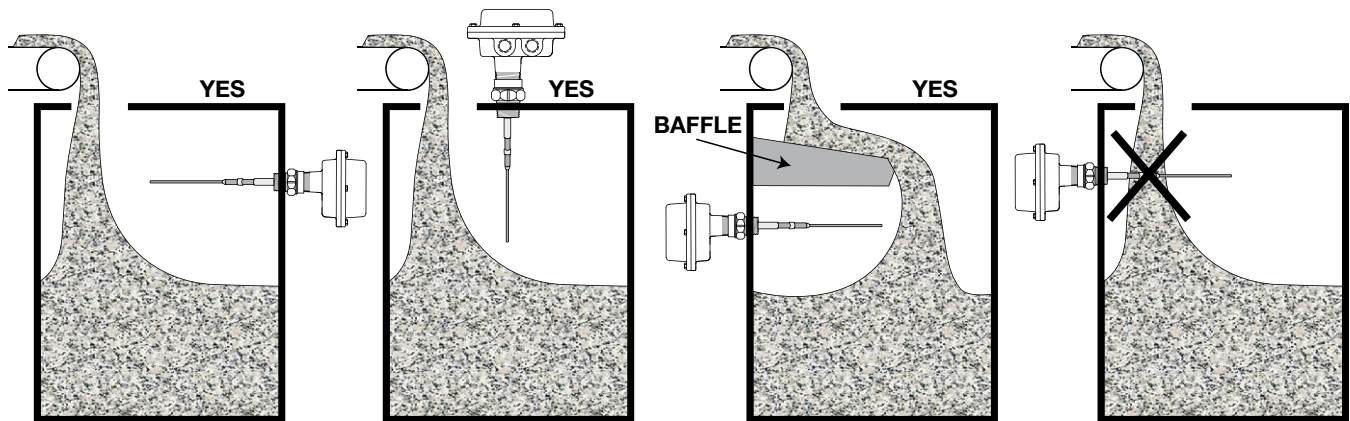

If the fork is mounted horizontally, it must be positioned so that the material will not accumulate on top of the tines. There is an index mark on the mounting nut to assist in proper positioning of the fork.

**Figure 3. Index Mark Positioning**

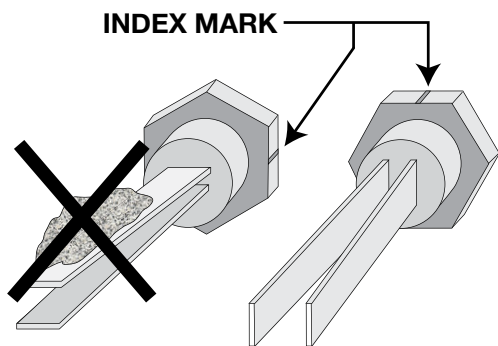

## V. ELECTRICAL INSTALLATION



**WARNING: VERY HIGH VOLTAGE IS PRESENT. REMOVE POWER FROM THE UNIT BEFORE INSTALLING, REMOVING, OR MAKING ADJUSTMENTS**

### GENERAL SAFETY

When using electrical equipment, you should always follow basic safety precautions, including the following:

- The installation and wiring of this product must comply with all national, federal, state, municipal, and local codes that apply.
- Properly ground the enclosure to an adequate earth ground.
- Do not modify any factory wiring. Connections should only be made to the terminals described in this section.
- All connections to the LP II Series models must use conductors with an insulation rating of 300 V minimum, rated for 212° F (105° C), a minimum flammability rating of VW-1, and be of appropriate gauge for the voltage and current required (see Specifications).
- Do not allow moisture to enter the electronics enclosure. Conduit should slope downward from the LP II housing. Install drip loops and seal conduit with silicone rubber product.

### DISCONNECT REQUIREMENTS FOR PERMANENTLY INSTALLED EQUIPMENT

A dedicated disconnecting device (circuit breaker) must be provided for the proper installation of the unit. If independent circuits are used for power input and main relay outputs, individual disconnects are required.

Disconnects must meet the following requirements:

- Located in close proximity to the device
- Easily accessible to the operator
- Appropriately marked as the disconnect for the device and associated circuit
- Sized appropriately to the requirements of the protected circuit (See Specifications)

### PROTECTIVE EARTH GROUND

To eliminate shock hazards in the unlikely event of an internal insulation breakdown, the unit is provided with an “earth” lead which must be connected to earth ground. In addition, the input power ground lead must be connected to the “protective earth” (  ) terminal provided. Wire sizes must be selected such that it can safely carry the sum total of all circuits’ maximum amperage.

### CONDUIT CABLE CONNECTION

Two threaded female conduit openings are provided in the housing for input and output wiring. When only one conduit opening is used for installation, the unused opening must be sealed with a suitable type 4X/IP66 plug with pipe sealant in order to maintain approval requirements.

## ELECTRICAL CONNECTIONS

Note: The LP II can be operated from 120-240 VAC 50/60 Hz or 24-48 VDC and provides reverse polarity protection in the event of a wiring error.

### LP II SERIES INTEGRAL MODEL ONLY

#### Input Power Connections

1. Refer to Figures 4 or 5 and 6 when connecting input power to the unit.
2. Loosen the housing cover screws and remove cover.



**CAUTION: IF THE UNIT WAS SUPPLIED WITH A GASKET AVOID FOLDING, CUTTING, OR TEARING GASKET. DAMAGING THE GASKET CAN ALLOW MOISTURE TO ENTER THE ENCLOSURE AND DAMAGE THE UNIT.**

Note: Two threaded female conduit openings are provided in the housing to separate input and output wiring.

3. Pull approximately 4.5" of cable through conduit closest to the grounding bracket and strip as follows:
  - a. Ground –  $\frac{3}{8}$ " (9 to 10 mm)
  - b. Power Leads –  $\frac{1}{4}$ " (6 to 7 mm)
4. Attach incoming ground lead to grounding bracket as shown in Figure 6.

Note: The LP II incorporates pluggable terminal blocks for ease of connection. If the terminal block is unplugged while making connections, ensure it is seated properly when reinstalled.

5. Attach power leads to terminal block as shown in Figure 4 or 5.
6. Check that all wires are held tightly in place by lightly pulling each conductor.

#### Main Relay Connections

7. Refer to Figures 4 or 5 and 7 when connecting to the main relay.
8. Pull approximately 4.5" (11.43 cm) of cable through conduit and strip  $\frac{1}{4}$ " (6 to 7 mm).
9. Attach leads to terminal block as shown in Figure 6.
10. Check that all wires are held tightly in place by lightly pulling each conductor.

**For STANDARD models skip to Step 15; for ADVANCED models continue to Step 11.**

#### Auxiliary Relay Connections - ADVANCED ONLY

11. Refer to Figures 4 or 5 and 8 when connecting to the auxiliary relay.
12. Pull approximately 5.5" (13.97 cm) of cable through conduit and strip  $\frac{1}{4}$ " (6 to 7 mm).
13. Attach leads to terminal block as shown in Figure 6.
14. Check that all wires are held tightly in place by lightly pulling each conductor.
15. Reinstall the gasket, if necessary.

16. Replace cover and tighten screws to 60 in-lb (6.8 n-m) of torque.

## LP II SERIES REMOTE MODEL ONLY

### Input Power Connections

1. Refer to Figures 4 or 5 and 6 when connecting input power to the unit.
2. Loosen set screw that locks cover in place.
3. Unscrew the housing cover and remove.

Note: Two threaded female conduit openings are provided in the remote housing to separate input and output wiring from the remote fork wiring.

4. Pull approximately 6" (15.24 cm) of cable through conduit closest to grounding bracket and strip as follows:
  - a. Ground –  $\frac{3}{8}$ " (9 to 10 mm)
  - b. Power Leads –  $\frac{1}{4}$ " (6 to 7 mm)
5. Attach incoming ground lead to grounding bracket as shown in Figure 6.

Note: The LP II incorporates pluggable terminal blocks for ease of connection. If the terminal block is unplugged while making connections, ensure it is seated properly when reinstalled.

6. Attach power leads to terminal block as shown in Figure 4 or 5.
7. Check that all wires are held tightly in place by lightly pulling each conductor.

### Main Relay Connections

8. Refer to Figures 4 or 5 and 7 when connecting to the main relay.
9. Pull approximately 9" (22.86 cm) of cable through conduit and strip  $\frac{1}{4}$ " (6 to 7 mm).
10. Attach leads to terminal block as shown in Figure 7.
11. Check that all wires are held tightly in place by lightly pulling each conductor.

### Auxiliary Relay Connections - ADVANCED ONLY

12. Refer to Figures 5 and 8 when connecting to the auxiliary relay.
13. Pull approximately 2.5" (6.35 cm) of cable through conduit and strip  $\frac{1}{4}$ " (6 to 7 mm).
14. Attach leads to terminal block as shown in Figure 8.
15. Check that all wires are held tightly in place by lightly pulling each conductor.

### Remote Fork Connections

16. Refer to Figure 9 or 10 and 11 when connecting the remote fork.
17. Pull approximately 2.5" (6.35 cm) of cable through conduit and strip  $\frac{3}{16}$ " (4 to 5 mm).
18. Connect factory supplied cable to terminals block as shown in Figure 11.
19. Check that all wires are held tightly in place by lightly pulling each conductor.

20. Replace cover and tighten set screw to lock cover in place.
22. Loosen the remote fork housing cover screws and remove cover.
23. Pull approximately 4" (10.16 cm) of cable through conduit and strip  $\frac{3}{16}$ " (4 to 5 mm).
24. Connect factory supplied cable to terminals block as shown in Figure 11.
25. Check that all wires are held tightly in place by lightly pulling each conductor.
26. Reinstall the gasket, if necessary.
27. Replace cover and tighten screws to 60 in-lb (6.8 n-m) of torque.



**CAUTION: IF THE UNIT WAS SUPPLIED WITH A GASKET AVOID FOLDING, CUTTING, OR TEARING GASKET. DAMAGING THE GASKET CAN ALLOW MOISTURE TO ENTER THE ENCLOSURE AND DAMAGE THE UNIT.**

Figure 4. LP II Integral Enclosure with Cover Removed - STANDARD

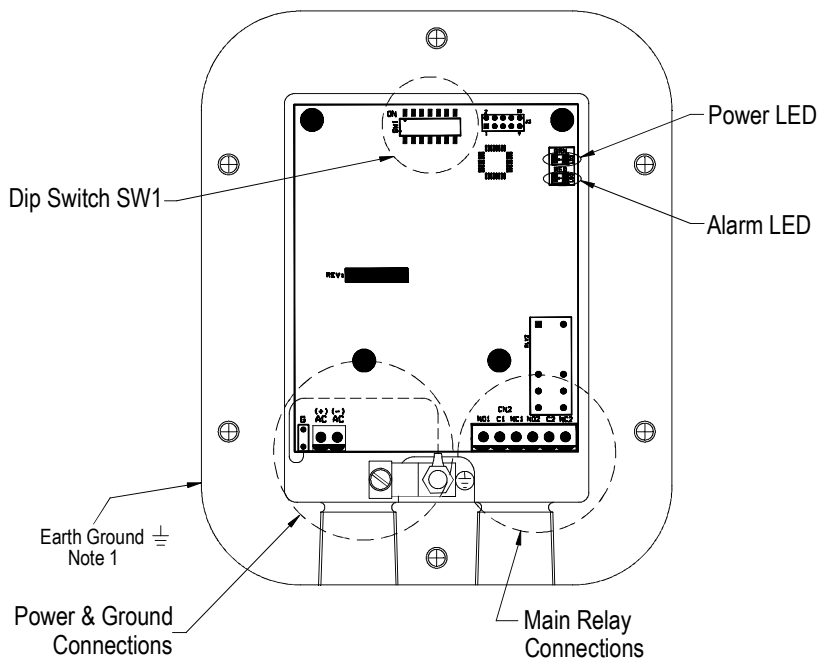

Notes:

- 1) For Safety, Properly Ground the Enclosure to an Adequate Earth Ground.

Figure 5. LP II Integral Enclosure with Cover Removed - ADVANCED

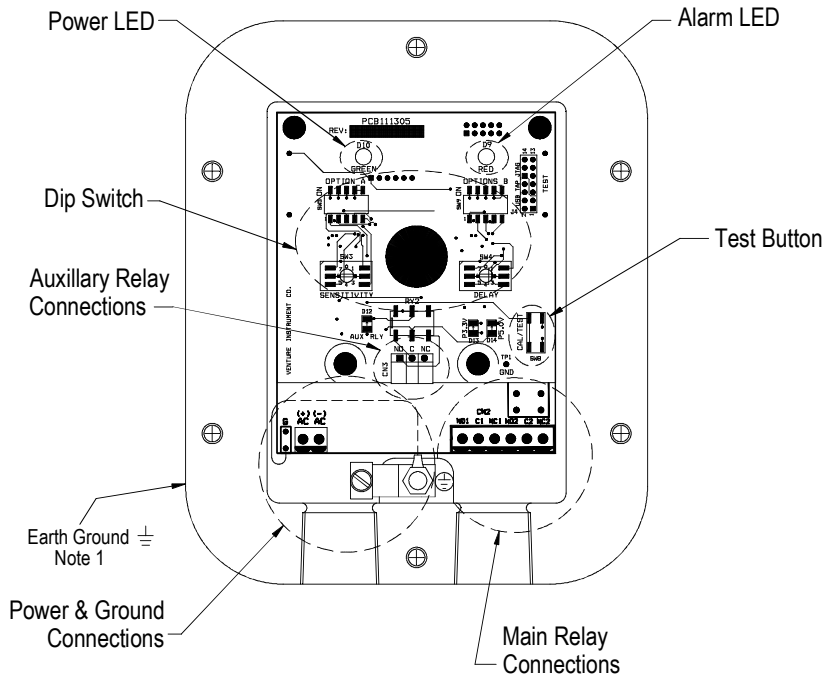

Notes:  
1) For Safety, Properly Ground the Enclosure to an Adequate Earth Ground.

Figure 6. Power and Ground Connections

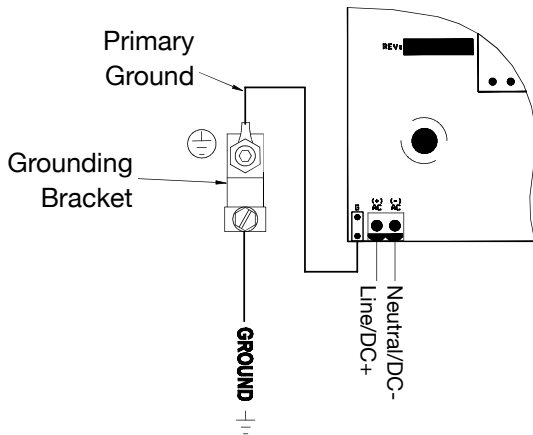

Figure 7. Main Relay Connections

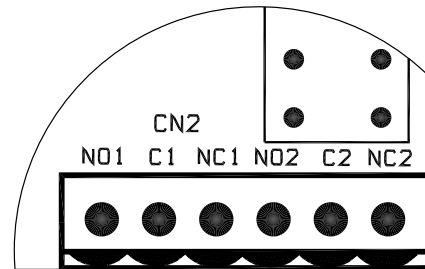

Figure 8. Auxillary Relay Connections - ADVANCED ONLY

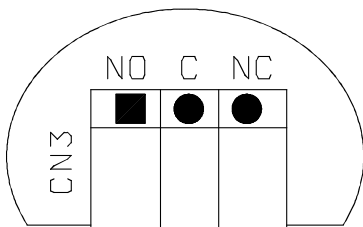

Figure 9. LP II Remote Enclosure with Cover Removed - STANDARD

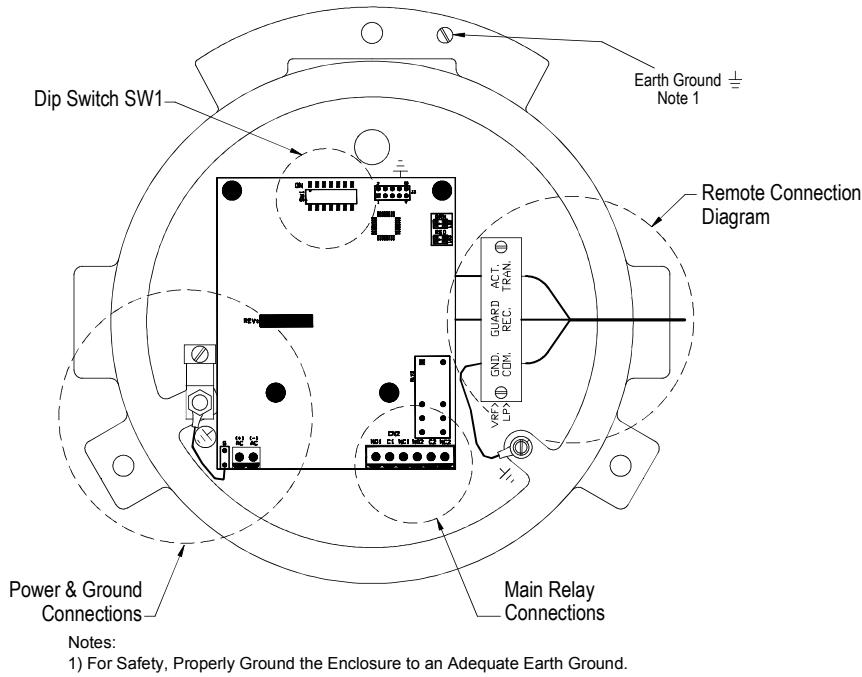

Figure 10. LP II Remote Enclosure with Cover Removed - ADVANCED

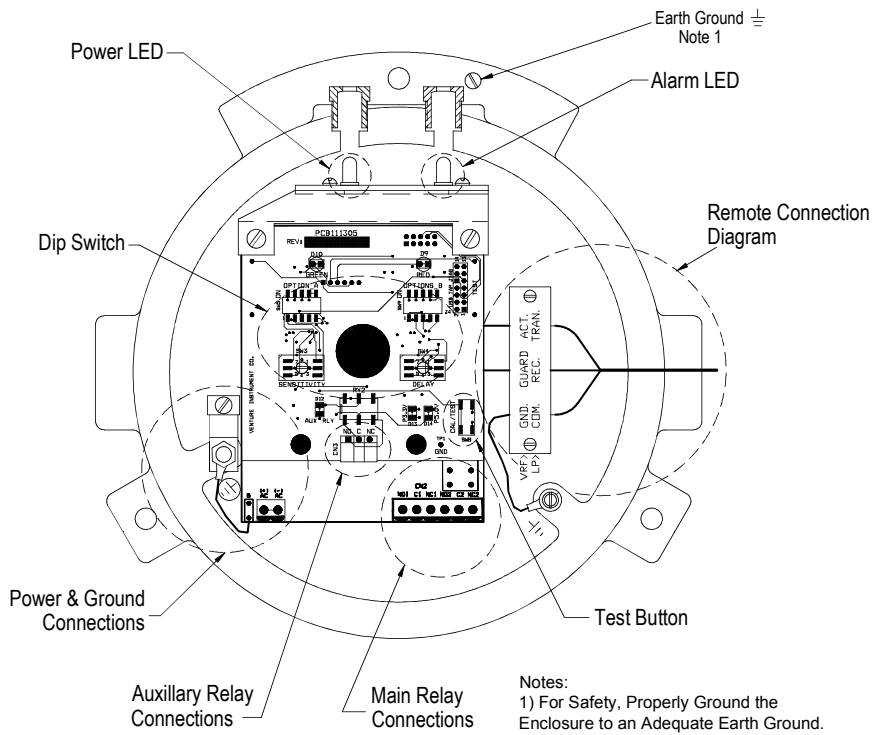
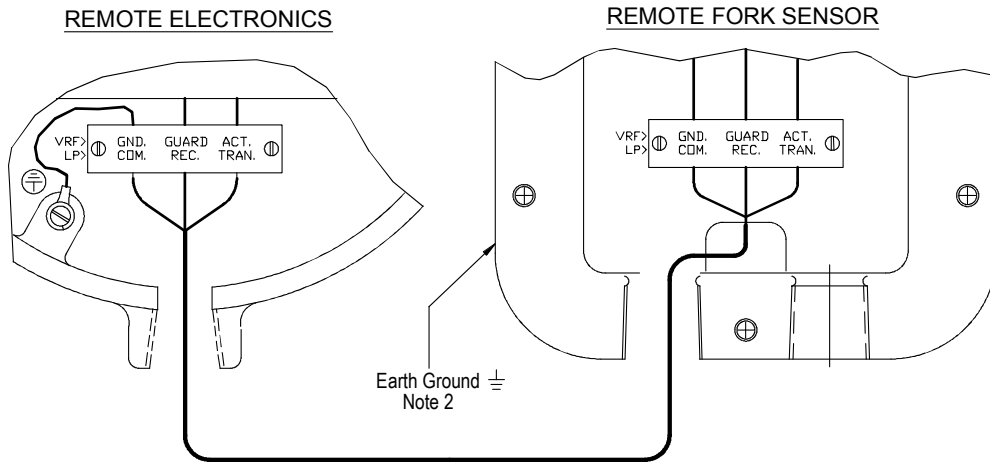



Figure 11. LP II Remote Connection Diagram



**WIRING COLORS**  
**For both Standard and HI-temp Cable Assembly**  
 COM. = SHIELD  
 REC. = WHITE  
 TRAN. = RED

Notes:

- 1) Maximum cable length is 100ft.
- 2) For Safety, Properly Ground the Enclosure to an Adequate Earth Ground.

## VI. SET-UP



**WARNING: VERY HIGH VOLTAGE IS PRESENT ON THE FORK TERMINALS.**

**REMOVE POWER FROM THE UNIT BEFORE INSTALLING, REMOVING, OR MAKING ADJUSTMENTS**

### OPERATION

The LP II does not require calibration. When power is applied to the unit, the tines of the fork will begin vibrating (if the fork is not impeded by contact with material or some other object). The green Power LED will be illuminated whenever power is applied to the unit. The status of the red Alarm LED is determined by the selected fail-safe mode and whether or not the fork is vibrating. Refer to Fail-Safe Selection section.

### PRODUCT OVERVIEW - STANDARD

Figures 4 and 7 show the electronics of the integral and remote versions of the LP II respectively. The figures show the location of the electrical connections, dip switches SW1, and the Power and Alarm LEDs. This section will discuss configuration for optimum performance in a given application. The settings are controlled by SW1 as shown in Figure 12.

Figure 12: Switch Functions, Standard

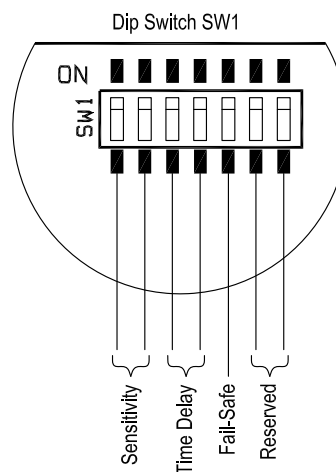

### PRODUCT OVERVIEW - ADVANCED ONLY

Figures 4 and 8 show the electronics of the integral and remote versions of the LP II respectively. The figures show the location of the electrical connections, dip switches SW5, two rotary switches SW3 and 4, and the Power and Alarm LEDs. This section will discuss configuration for optimum performance in a given application. The settings are controlled by SW3 through 5 as shown in Figure 13.

Figure 13: Switch Functions, Advanced

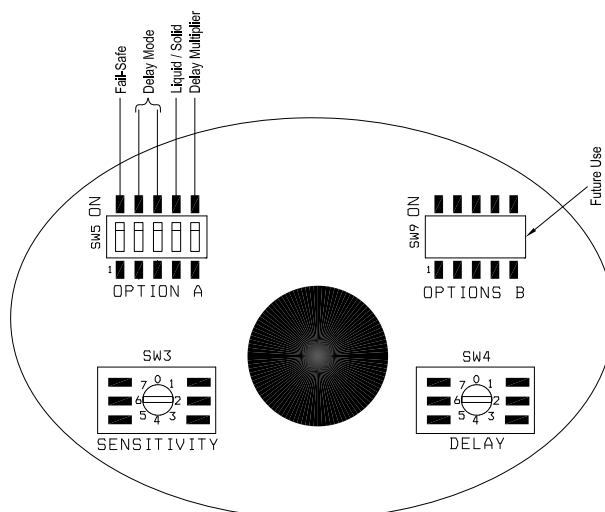

### BUILD UP DETECTION - ADVANCED ONLY

If the LP II detects that product is beginning to build up on the forks and may inhibit normal operations of the unit, the auxiliary relay will drop out and the Power LED will flash. To avoid false readings, remove the unit, clean material adhered to the forks and reinstall.

## FAIL-SAFE SELECTION

The LP II is factory set for high level fail-safe operation. The Fail-Safe is controlled by SW1, position 5. Refer to Figure 14 to determine the Fail-Safe mode that suits your application.

Figure 14. Fail-Safe Operation

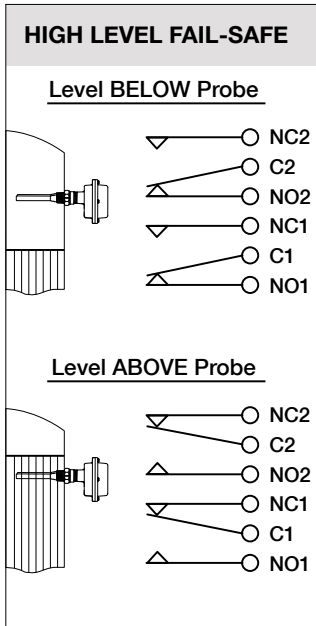

### HIGH LEVEL FAIL-SAFE OPERATION (DEFAULT)

#### DIP Switch

- STANDARD: SW1-5 is OFF
- ADVANCED: SW5-1 is OFF

#### Alarm State (material above the fork)

- Main Relay is de-energized  
Relay NC contacts are closed  
Relay NO contacts are open
- Alarm LED is ON

#### Non-Alarm State (material above the fork)

- Main Relay is energized  
Relay NC contacts are open  
Relay NO contacts are closed
- Alarm LED is OFF

Note: If the electrical power fails, the main relay turns OFF, giving the same indication as if material is above the fork.

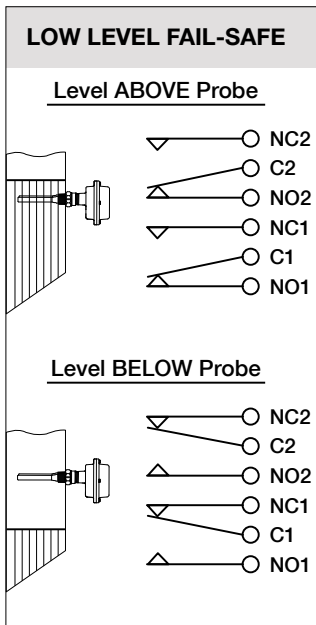

### LOW LEVEL FAIL-SAFE OPERATION

#### DIP Switch

- STANDARD: SW1-5 is ON
- ADVANCED: SW5-1 is ON

#### Alarm State (material below the fork)

- Main Relay is de-energized  
Relay NC contacts are closed  
Relay NO contacts are open
- Alarm LED is ON

#### Non-Alarm State (material above the fork)

- Main Relay is energized  
Relay NC contacts are open  
Relay NO contacts are closed
- Alarm LED is OFF

Note: If the electrical power fails, the main relay turns OFF, giving the same indication as if material is below the fork.

### TIME DELAY SETTINGS - STANDARD

This setting will delay the time between when the LP II senses material and the main relay changes state. **The delay is only in this direction, regardless of fail-safe setting.** There is no added delay when the material leaves the fork. There is a fixed internal delay when material leaves the fork and this delay varies from 1 to 3 seconds as the sensitivity is changed from lowest sensitivity (high vibration) to high sensitivity (lowest vibration). Duration of an additional delay is determined by SW1 positions 3, and 4 as described in the table below. The LP II is factory set for the minimum delay.

SW1 Position 3	SW1 Position 4	Delay (seconds)
OFF	OFF	1-3
OFF	ON	1
ON	OFF	3
ON	ON	6

### TIME DELAY SETTINGS - ADVANCED ONLY

The time between when the LP II senses material, or its absence, and the output relay changes state is field programmable using SW5 Positions 2 and 3. The delay can be for when the product touches the fork or when the product leaves the fork or both regardless of the fail-safe setting.

SW5 Position 2	Delay Mode
ON	The selected delay by the SW4 is applied when material touches the fork
OFF	There is no delay when material touches the fork
SW5 Position 3	Delay Mode
ON	The selected delay by the SW4 is applied when material leaves the fork
OFF	There is no delay when material leaves the fork

### SENSITIVITY SETTINGS - STANDARD

There are four different sensitivity ranges on the LP II that can be selected using SW1 Position 1 and 2. The unit is factory set for the lowest sensitivity. The table below is for illustration purposes, of a vertically mounted unit only, and results will vary depending on material properties and conditions. The values in this table are shown with material density of 0.8 lbs/ft<sup>3</sup> at 77° F (25° C). For units mounted horizontally, where sensitivity settings are less significant; it is recommended that SW1 Positions 1 & 2 be “ON” position to minimize material build-up on the forks.

SW1 Position 1	SW1 Position 2	Sensitivity	INSERTION DEPTH
OFF	OFF	FACTORY RESERVED	
OFF	ON	High	1.8
ON	OFF	Medium	2.1
ON	ON	Low	2.4

### SENSITIVITY SETTINGS - ADVANCED

The LP II provides 8 levels of sensitivity which are selected using SW3 as shown in the table below. The unit is factory set for the lowest sensitivity. To adjust the sensitivity of the LP II, SW5 Position 4 must be in the OFF position to disable the liquid/solid interface function. The table below is for illustration purposes, of a vertically mounted unit only, and results will vary depending on material properties and conditions. The values in this table are shown with material density of 0.8 lbs/ft<sup>3</sup> at 77° F (25° C). For units mounted horizontally, where sensitivity settings are less significant; it is recommended that SW3 be set to Position 7 to minimize material build-up on the forks.

SW3	Sensitivity	Insertion Depth (inches)
0	FACTORY RESERVED	
1		
2	280	1.5
3	240	1.8
4	223	2.1
5	206	2.4
6	190	2.7
7	173	3.5

Note: If the liquid/solid interface is activated, then the sensitivity function is disabled.

### LIQUID/SOLID INTERFACE - ADVANCED ONLY

To activate the liquid/solid interface SW5 Position 4 must be in the ON position. When this feature of the LP II is enabled, the sensitivity selection by the SW3 will be ignored.

Note: Activating liquid/solid interface will disable the sensitivity function.

### TEST - ADVANCED ONLY

The LP II provides a means for self-test using the magnetic FOB provided with the unit. When the unit is not in material (forks vibrating) place and hold the FOB over the “TEST” label on the cover. If the unit is functioning properly, the unit will alarm according to the selected fail-safe mode as shown below. When the test is completed and results verified, simply move the FOB away from the unit.

**HIGH FAIL-SAFE:**

- Main relay de-energizes
- Red ALARM LED is on

**LOW FAIL-SAFE**

- Main relay energizes
- Red ALARM LED is off

Figure 15: Magnetic FOB

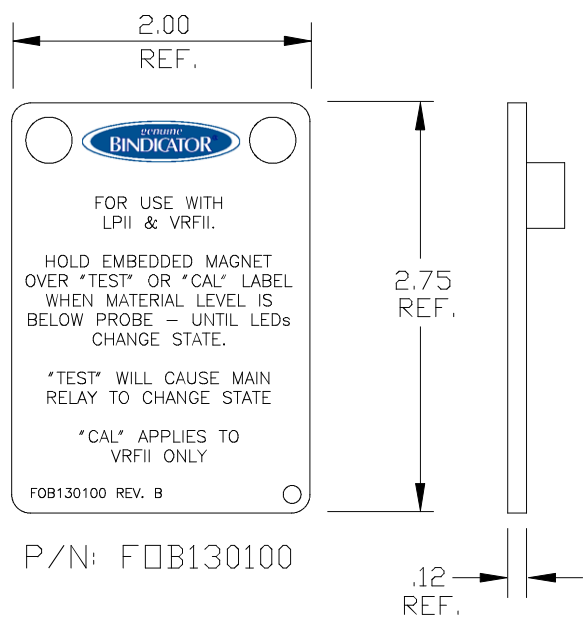

P/N: FOB130100

## VII. MAINTENANCE

### PREVENTATIVE MAINTENANCE

No scheduled preventative maintenance is required for the LP II Series units when properly applied and installed correctly. There is no cleaning required for the unit before or during installation.

If the cover is removed after the unit has been in service, it is recommended to replace the gasket to prevent the ingress of water or dust. At a minimum the gasket should be inspected for folds, cracks, and tears.

## VIII. TROUBLESHOOTING

	<b>SYMPTOM</b>	<b>POSSIBLE CAUSE</b>	<b>SOLUTION</b>
The unit is not responsive	Main relay not Functioning and Power LED is not illuminated	No power, Blown fuse	Apply proper AC/DC voltage to the board and recheck the unit.  If power is present and Power LED is not illuminated, then the main fuse is blown.  Replace electronics.
	Main relay is functioning and Power LED is illuminated	Electronic failure, or main relay contacts are fused	Replace electronics.

# IX. DIMENSIONAL DRAWINGS

### TOP VIEW

3.01 (76.5)  
7.14 (181.4)  
2.95 (74.9)  
5.89 (149.6)  
1/4 X 20  
M8 X 1.25

### SIDE VIEW

7.38 (187.5)  
3.34 (84.8)  
.21 (5.33) \*NOTE 2\*  
8.00 (203)  
DIM. A  
(SEE DIMENSION TABLE)

**GREEN L.E.D. (POWER)** \*NOTE 2\*

**RED L.E.D. (ALARM)** \*NOTE 2\*

**EXT. GROUND SCREW**

**(X2) 3/4" NPT OR M20 X 1.5 CONDUIT OPENING** \*NOTE 3\*

**MOUNTING THREAD** (SEE DIMENSION TABLE BELOW)

**INDEX MARKS MUST BE ALIGNED VERTICALLY IF FORK IS MOUNTED HORIZONTALLY** \*NOTE 1\*

#### DIMENSION TABLE

PROCESS FITTING	C2	D2	F2
MOUNTING THREAD	1-1/4"	1-1/2"	BSP 1-1/2"
DIM A	1.4" NDM (35.56mm)	1.7" NDM (43.18mm)	1.7" NDM (43.18mm)

OUTLINE DWG FOR LPII STANDARD UNIT with C2, D2, & F2 PROCESS FITTINGS

**\*NOTE\***

- 1-INSTALL FORKS WITH OPENING BETWEEN TINES ALIGNED WITH CONDUIT HOLES IN FRAME AS SHOWN.
- 2-STANDARD AND REMOTE FORKS WILL NOT HAVE LIGHTS. ONLY ADVANCED UNITS WILL HAVE LIGHTS.
- 3-FOR HORIZONTAL MOUNTING, CONDUIT OPENINGS MUST FACE DOWNWARDS AND INCLUDE DRIPLOOP.

UP

DETAIL A

END VIEW OF FORK SHOWING ORIENTATION OF TINES (HORIZONTAL INSTALLATION)

DO NOT SCALE. DIMENSIONS ARE IN INCHES. BRACKETED DIMENSIONS ARE IN MILLIMETERS.

A	INIT. RELEASE	13-300	ECN #	DRWN/CK'D BY	DATE	APP'D BY	DATE
<b>REVISIONS</b>							

<b>venture</b> MEASUREMENT 150 VENTURE BLVD. SPARTANBURG, SC 29306	FILE LVP280007_A_*	REF	MATERIAL	FINISH
DESIGNED BY: J1 DRAWN BY: J1 CHECKED BY: J1 APPROVED BY: J1/TOBS JOB © - ORIGINAL DIM OR NOT				

TITLE Outline Drawing for LPII Standard Unit	SCALE NONE	SIZE A	SHEET 1 of 1
---	---------------	-----------	-----------------



150 Venture Boulevard  
Spartanburg, SC 29306  
Tel: (800) 778-9242  
Fax: (864) 574-8063  
sales@bindicator.com  
www.bindicator.com

**venture**  
MEASUREMENT

2013 All rights reserved.  
All data subject to change without notice.

LVP180613 Rev. A